

## ORBIT PENDANT

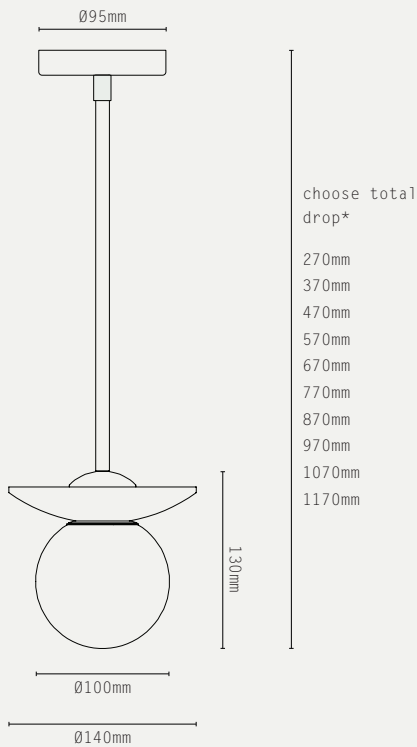

\*longer drop available at extra cost

### LIGHT SOURCE:

G9 LAMP BASE  
(12W MAX, LED ONLY)

### LAMP SUPPLIED:

1 X G9 LED / 2700K / 3W /  
250 LUMENS

### DIMMABLE:

PHASE (MAINS) DIMMING (USING  
SUPPLIED LAMP)

### VOLTAGE:

240V AC (CLASS I)

### CERTIFICATIONS:

CE / UKCA

### MATERIALS:

BRASS, OPAL GLASS,  
NATURAL STONE

### WEIGHT:

3 KG (APPROX)

### HANGING OPTIONS:





DROP ROD AT 100MM INCREMENTS

### ADDITIONAL INFO:





DESIGNED BY WILL EARL 2022

MADE IN ENGLAND

### METAL FINISHES:

-  ANTIQUE BRASS
-  BRONZE
-  SATIN BRASS
-  SATIN NICKEL

### STONE OPTIONS:

-  BLACK MARBLE
-  GREEN MARBLE
-  RED MARBLE
-  TRAVERTINE

### PRODUCT CODES:

ORB.P.AB.BM - ANTIQUE BRASS / BLACK MARBLE

ORB.P.AB.GM - ANTIQUE BRASS / GREEN MARBLE

ORB.P.AB.RM - ANTIQUE BRASS / RED MARBLE

ORB.P.AB.TV - ANTIQUE BRASS / TRAVERTINE

ORB.P.BZ.BM - BRONZE / BLACK MARBLE

ORB.P.BZ.GM - BRONZE / GREEN MARBLE

ORB.P.BZ.RM - BRONZE / RED MARBLE

ORB.P.BZ.TV - BRONZE / TRAVERTINE

## ORBIT WALL LIGHT

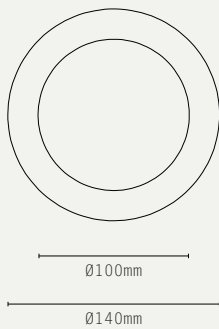
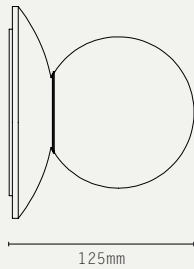

**LIGHT SOURCE:**

G9 LAMP BASE  
(12W MAX, LED ONLY)

**LAMP SUPPLIED:**

1 X G9 LED/ 2700K / 3W /  
250 LUMENS

**DIMMABLE:**

PHASE (MAINS) DIMMING (USING  
SUPPLIED LAMP)

**VOLTAGE:**

240V AC (CLASS I)

**CERTIFICATIONS:**

CE / UKCA  
IP44

**MATERIALS:**

BRASS, OPAL GLASS, NATURAL  
STONE





**WEIGHT:**

1.2 KG (APPROX)

**ADDITIONAL INFO:**

DESIGNED BY WILL EARL 2022  
MADE IN ENGLAND

**STONE OPTIONS:**

-  BLACK MARBLE
-  GREEN MARBLE
-  RED MARBLE
-  TRAVERTINE

**PRODUCT CODES:**

ORB.W.BM - BLACK MARBLE  
ORB.W.GM - GREEN MARBLE  
ORB.W.RM - RED MARBLE  
ORB.W.TV - TRAVERTINE