

NOVA GLOBE PENDANT

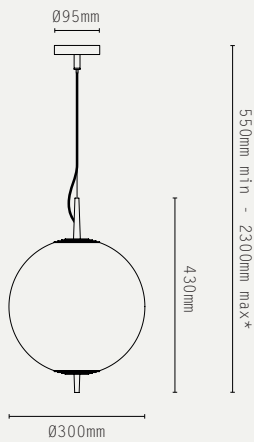

CABLE:



DROP ROD:

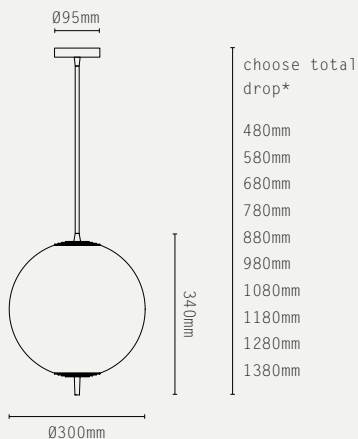

*longer drop available at extra cost

LIGHT SOURCE:

E27 LAMP BASE (20W MAX)

LAMP SUPPLIED:

1 X E27 LED / 2700K / 8.5W /
470 LUMENS

DIMMABLE:

PHASE (MAINS) DIMMING (USING
SUPPLIED LAMP)

VOLTAGE:

240V AC (CLASS II)

CERTIFICATIONS:

CE / UKCA

MATERIALS:

BRASS, GLASS

WEIGHT:

6 KG (APPROX)

HANGING OPTIONS:





- SUSPENSION WIRE WITH CABLE
- DROP ROD AT 100M INCREMENTS

ADDITIONAL INFO:

DESIGNED BY WILL EARL 2020

MADE IN ENGLAND

METAL FINISHES:

-  ANTIQUE BRASS
-  BRONZE
-  SATIN BRASS
-  SATIN NICKEL

PRODUCT CODES:

NOV.PGL.AB.MO - ANTIQUE BRASS / OPAL GLASS / SUSPENSION WIRE

NOV.PGL.BZ.MO - BRONZE / OPAL GLASS / SUSPENSION WIRE

NOV.PGL.SB.MO - SATIN BRASS / OPAL GLASS / SUSPENSION WIRE

NOV.PGL.SN.MO - SATIN NICKEL / OPAL GLASS / SUSPENSION WIRE

NOV.PGL.R.AB.MO - ANTIQUE BRASS / OPAL GLASS / DROP ROD

NOV.PGL.R.BZ.MO - BRONZE / OPAL GLASS / DROP ROD

NOV.PGL.R.SB.MO - SATIN BRASS / OPAL GLASS / DROP ROD

NOV.PGL.R.SN.MO - SATIN NICKEL / OPAL GLASS / DROP ROD

NOVA WIDE PENDANT

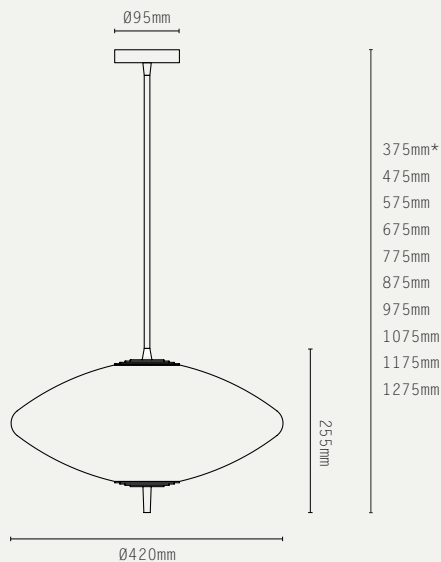

*choose total drop - longer drop available at extra cost

LIGHT SOURCE:

E27 LAMP BASE (20W MAX)

LAMP SUPPLIED:

1 X E27 / 2700K / 8.5W /
470 LUMENS

DIMMABLE:

PHASE (MAINS) DIMMING (USING
SUPPLIED LAMP)

VOLTAGE:

240V AC (CLASS II)

CERTIFICATIONS:

CE / UKCA

MATERIALS:

BRASS, GLASS

WEIGHT:

6 KG (APPROX)

HANGING OPTIONS:





DROP ROD AT 100MM INCREMENTS

ADDITIONAL INFO:

DESIGNED BY WILL EARL 2020

MADE IN ENGLAND

METAL FINISHES:

-  ANTIQUE BRASS
-  BRONZE
-  SATIN BRASS
-  SATIN NICKEL

PRODUCT CODES:

NOV.PWI.R.AB.MO - ANTIQUE BRASS / OPAL GLASS / DROP ROD

NOV.PWI.R.BZ.MO - BRONZE / OPAL GLASS / DROP ROD

NOV.PWI.R.SB.MO - SATIN BRASS / OPAL GLASS / DROP ROD

NOV.PWI.R.SN.MO - SATIN NICKEL / OPAL GLASS / DROP ROD

NOVA TALL PENDANT



CABLE:

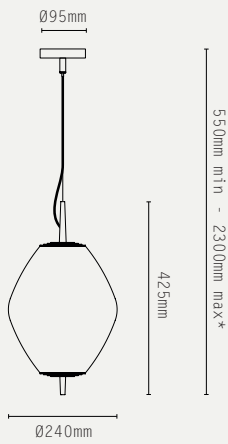

DROP ROD:

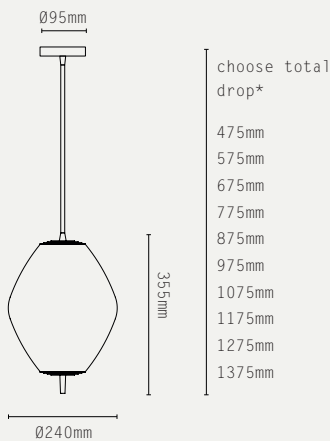

*longer drop available at extra cost

LIGHT SOURCE:

E27 LAMP BASE (20W MAX)

LAMP SUPPLIED:

1 X E27 LED / 2700K / 8.5W / 470 LUMENS

DIMMABLE:

PHASE (MAINS) DIMMING (USING SUPPLIED LAMP)

VOLTAGE:

240V AC (CLASS II)

CERTIFICATIONS:

CE / UKCA

MATERIALS:

BRASS, GLASS

WEIGHT:

5.5 KG (APPROX)

HANGING OPTIONS:





- SUSPENSION WIRE WITH CABLE
- DROP ROD AT 100MM INCREMENTS

ADDITIONAL INFO:

DESIGNED BY WILL EARL 2020

MADE IN ENGLAND

METAL FINISHES:

-  ANTIQUE BRASS
-  BRONZE
-  SATIN BRASS
-  SATIN NICKEL

PRODUCT CODES:

NOV.PTA.AB.MO - ANTIQUE BRASS / OPAL GLASS / SUSPENSION WIRE

NOV.PTA.BZ.MO - BRONZE / OPAL GLASS / SUSPENSION WIRE

NOV.PTA.SB.MO - SATIN BRASS / OPAL GLASS / SUSPENSION WIRE

NOV.PTA.SN.MO - SATIN NICKEL / OPAL GLASS / SUSPENSION WIRE

NOV.PTA.R.AB.MO - ANTIQUE BRASS / OPAL GLASS / DROP ROD

NOV.PTA.R.BZ.MO - BRONZE / OPAL GLASS / DROP ROD

NOV.PTA.R.SB.MO - SATIN BRASS / OPAL GLASS / DROP ROD

NOV.PTA.R.SN.MO - SATIN NICKEL / OPAL GLASS / DROP ROD

NOVA SLIM PENDANT



LIGHT SOURCE:

E27 LAMP BASE (20W MAX)

MATERIALS:

BRASS, GLASS

LAMP SUPPLIED:

1 X E27 LED / 2700K / 5.5W /
470 LUMENS

WEIGHT:

1.8 KG (APPROX)

HANGING OPTIONS:

- ADJUSTABLE BRAIDED CABLE
- DROP ROD AT 100MM INCREMENTS

DIMMABLE:

PHASE (MAINS) DIMMING (USING
SUPPLIED LAMP)

ADDITIONAL INFO:

DESIGNED BY WILL EARL 2021

VOLTAGE:

240V AC (CLASS II)

MADE IN ENGLAND

CERTIFICATIONS:

CE / UKCA



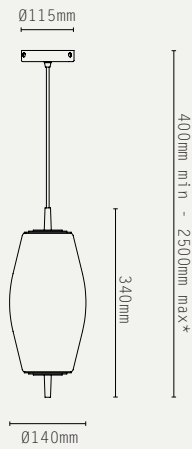

CABLE:

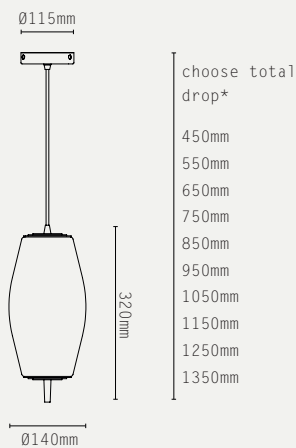

DROP ROD:



METAL FINISHES:

-  ANTIQUE BRASS
-  BRONZE
-  SATIN BRASS
-  SATIN NICKEL

PRODUCT CODES:

NOV.PSL.AB.MO - ANTIQUE BRASS / OPAL GLASS / CABLE

NOV.PSL.BZ.MO - BRONZE / OPAL GLASS / CABLE

NOV.PSL.SB.MO - SATIN BRASS / OPAL GLASS / CABLE

NOV.PSL.SN.MO - SATIN NICKEL / OPAL GLASS / CABLE

NOV.PSL.R.AB.MO - ANTIQUE BRASS / OPAL GLASS / DROP ROD

NOV.PSL.R.BZ.MO - BRONZE / OPAL GLASS / DROP ROD

NOV.PSL.R.SB.MO - SATIN BRASS / OPAL GLASS / DROP ROD

NOV.PSL.R.SN.MO - SATIN NICKEL / OPAL GLASS / DROP ROD

*longer drop available at extra cost

NOVA SLIM PENDANT - 3 DROP GROUPING

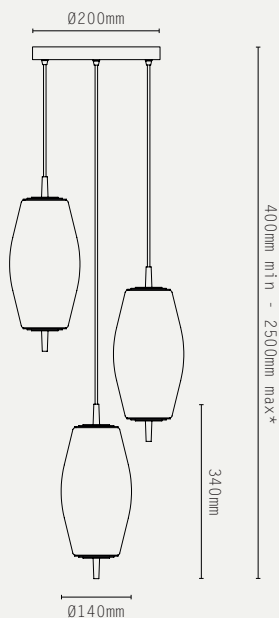

*longer cable available at extra cost

LIGHT SOURCE:

E27 LAMP BASE (20W MAX)

LAMP SUPPLIED:

3 X E27 / 2700K / 5.5W /
470 LUMENS

DIMMABLE:

PHASE (MAINS) DIMMING (USING
SUPPLIED LAMP)

VOLTAGE:

240V AC (CLASS II)

CERTIFICATIONS:

CE / UKCA

MATERIALS:

BRASS, GLASS

WEIGHT:

6 KG (APPROX)





HANGING OPTIONS:

- ADJUSTABLE BRAIDED CABLE
- DROP ROD (ON REQUEST)

ADDITIONAL INFO:

DESIGNED BY WILL EARL 2021
MADE IN ENGLAND

METAL FINISHES:

-  ANTIQUE BRASS
-  BRONZE
-  SATIN BRASS
-  SATIN NICKEL

PRODUCT CODES:

NOV.PSL3.AB.MO - ANTIQUE BRASS / OPAL GLASS
NOV.PSL3.BZ.MO - BRONZE / OPAL GLASS
NOV.PSL3.SB.MO - SATIN BRASS / OPAL GLASS
NOV.PSL3.SN.MO - SATIN NICKEL / OPAL GLASS

NOVA SLIM PENDANT - 6 DROP GROUPING

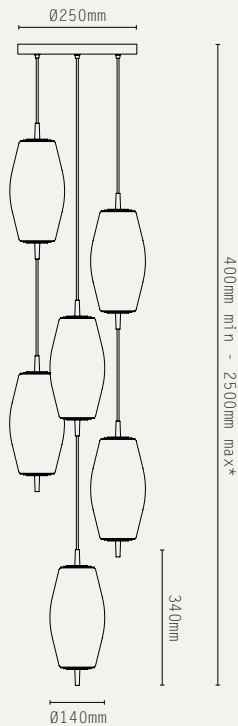

*longer cable available at extra cost

LIGHT SOURCE:

E27 LAMP BASE (20W MAX)

LAMP SUPPLIED:

6 X E27 / 2700K / 5.5W /
470 LUMENS

DIMMABLE:

PHASE (MAINS) DIMMING (USING
SUPPLIED LAMP)

VOLTAGE:

240V AC (CLASS II)

CERTIFICATIONS:

CE / UKCA

MATERIALS:

BRASS, GLASS

WEIGHT:

11 KG (APPROX)

HANGING OPTIONS:





- ADJUSTABLE BRAIDED CABLE
- DROP ROD (ON REQUEST)

ADDITIONAL INFO:

DESIGNED BY WILL EARL 2021

MADE IN ENGLAND

METAL FINISHES:

-  ANTIQUE BRASS
-  BRONZE
-  SATIN BRASS
-  SATIN NICKEL

PRODUCT CODES:

NOV.PSL6.AB.MO - ANTIQUE BRASS / OPAL GLASS

NOV.PSL6.BZ.MO - BRONZE / OPAL GLASS

NOV.PSL6.SB.MO - SATIN BRASS / OPAL GLASS

NOV.PSL6.SN.MO - SATIN NICKEL / OPAL GLASS

NOVA WALL LIGHT

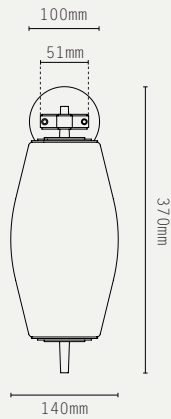

LIGHT SOURCE:

E27 LAMP BASE (20W MAX)

MATERIALS:

BRASS, GLASS

LAMP SUPPLIED:

1 X E27 LED / 2700K / 5.5W /
470 LUMENS

WEIGHT:

1.8 KG (APPROX)

DIMMABLE:

PHASE (MAINS) DIMMING (USING
SUPPLIED LAMP)

OPTIONAL ACCESSORIES:

- DEEP MOUNTING BACKBOX
- EU JUNCTION BOX ADAPTOR

VOLTAGE:

240V AC (CLASS II)

ADDITIONAL INFO:





DESIGNED BY WILL EARL 2021

MADE IN ENGLAND

CERTIFICATIONS:

CE / UKCA

METAL FINISHES:

-  ANTIQUE BRASS
-  BRONZE
-  SATIN BRASS
-  SATIN NICKEL

PRODUCT CODES:

NOV.W.AB.MO - ANTIQUE BRASS / OPAL GLASS

NOV.W.BZ.MO - BRONZE / OPAL GLASS

NOV.W.SB.MO - SATIN BRASS / OPAL GLASS

NOV.W.SN.MO - SATIN NICKEL / OPAL GLASS

NOVA TABLE LIGHT

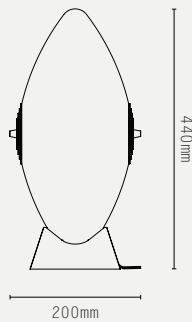
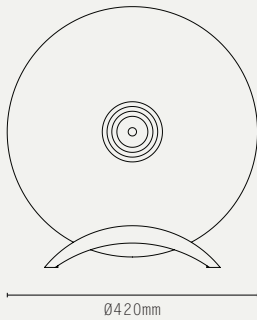

LIGHT SOURCE:

E27 LAMP BASE (20W MAX)

LAMP SUPPLIED:

1 X E27 LED / 2700K / 5.5W /
470 LUMENS

VOLTAGE:

240V AC (CLASS II)

CERTIFICATIONS:

CE / UKCA

MATERIALS:

BRASS, GLASS

WEIGHT:

7 KG (APPROX)

FLEX:

2M COTTON BRAIDED FLEX WITH
INLINE ON/OFF SWITCH

OPTIONS / ACCESSORIES:

- 5A PLUG
- INLINE DIMMER SWITCH

ADDITIONAL INFO:

DESIGNED BY WILL EARL 2021
MADE IN ENGLAND

METAL FINISHES:



ANTIQUE BRASS



BRONZE

PRODUCT CODES:

NOV.TWI.AB.MO - ANTIQUE BRASS / OPAL GLASS

NOV.TWI.BZ.MO - BRONZE / OPAL GLASS

NOV.TWI.AB.MO.EU - ANTIQUE BRASS / OPAL GLASS / EU PLUG

NOV.TWI.BZ.MO.EU - BRONZE / OPAL GLASS / EU PLUG