

## FLUME DOUBLE WALL LIGHT - IP44

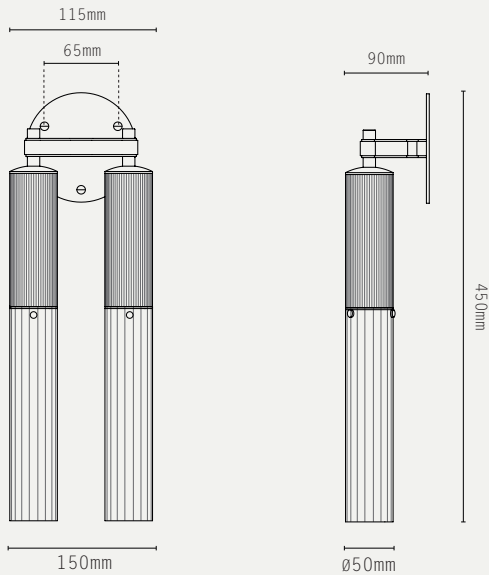

### LIGHT SOURCE:

GU10 LAMP BASE  
(12W MAX LED ONLY / 35MM MAX  
LAMP DIAMETER)

### LAMP SUPPLIED:

2 X GU10 MR11 LED/ 2700K /  
3.6W / 290 LUMENS

### DIMMABLE:

PHASE (MAINS) DIMMING (USING  
SUPPLIED LAMP)

### VOLTAGE:

240V AC (CLASS I)

### CERTIFICATIONS:

CE / UKCA  
IP44

### MATERIALS:

BRASS, GLASS

### WEIGHT:

3 KG (APPROX)





### OPTIONAL ACCESSORIES:

- DEEP MOUNTING BACKBOX  
- EU JUNCTION BOX ADAPTOR



### ADDITIONAL INFO:

DESIGNED BY WILL EARL 2019  
MADE IN ENGLAND

### METAL FINISHES:

-  ANTIQUE BRASS
-  BRONZE
-  SATIN BRASS
-  SATIN NICKEL

### GLASS OPTIONS:

-  CLEAR REEDED GLASS
-  FROSTED REEDED GLASS

### PRODUCT CODES:

FL.DW.IP.AB.CRG - ANTIQUE BRASS / CLEAR REEDED GLASS  
FL.DW.IP.BZ.CRG - BRONZE / CLEAR REEDED GLASS  
FL.DW.IP.SB.CRG - SATIN BRASS / CLEAR REEDED GLASS  
FL.DW.IP.SN.CRG - SATIN NICKEL / CLEAR REEDED GLASS

FL.DW.IP.AB.FRG - ANTIQUE BRASS / FROSTED REEDED GLASS  
FL.DW.IP.BZ.FRG - BRONZE / FROSTED REEDED GLASS  
FL.DW.IP.SB.FRG - SATIN BRASS / FROSTED REEDED GLASS  
FL.DW.IP.SN.FRG - SATIN NICKEL / FROSTED REEDED GLASS

## FLUME DOUBLE WALL LIGHT

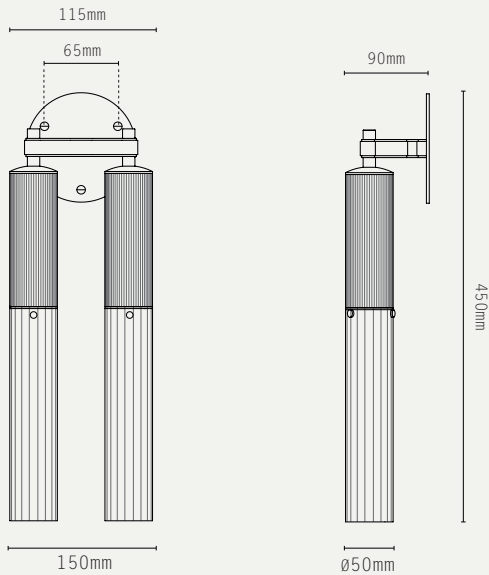

### LIGHT SOURCE:

GU10 LAMP BASE  
(12W MAX LED ONLY / 35MM MAX  
LAMP DIAMETER)

### LAMP SUPPLIED:

2 X GU10 MR11 LED/ 2700K /  
3.6W / 290 LUMENS

### DIMMABLE:

PHASE (MAINS) DIMMING (USING  
SUPPLIED LAMP)

### VOLTAGE:

240V AC (CLASS I)

### CERTIFICATIONS:

CE / UKCA

### MATERIALS:

BRASS, GLASS

### WEIGHT:

3 KG (APPROX)





### OPTIONAL ACCESSORIES:

- DEEP MOUNTING BACKBOX  
- EU JUNCTION BOX ADAPTOR



### ADDITIONAL INFO:

DESIGNED BY WILL EARL 2019  
MADE IN ENGLAND

### METAL FINISHES:

-  ANTIQUE BRASS
-  BRONZE
-  SATIN BRASS
-  SATIN NICKEL

### GLASS OPTIONS:

-  CLEAR REEDED GLASS
-  FROSTED REEDED GLASS

### PRODUCT CODES:

FL.DW.AB.CRG - ANTIQUE BRASS / CLEAR REEDED GLASS  
FL.DW.BZ.CRG - BRONZE / CLEAR REEDED GLASS  
FL.DW.SB.CRG - SATIN BRASS / CLEAR REEDED GLASS  
FL.DW.SN.CRG - SATIN NICKEL / CLEAR REEDED GLASS

FL.DW.AB.FRG - ANTIQUE BRASS / FROSTED REEDED GLASS  
FL.DW.BZ.FRG - BRONZE / FROSTED REEDED GLASS  
FL.DW.SB.FRG - SATIN BRASS / FROSTED REEDED GLASS  
FL.DW.SN.FRG - SATIN NICKEL / FROSTED REEDED GLASS