

## FLUME 80 PENDANT

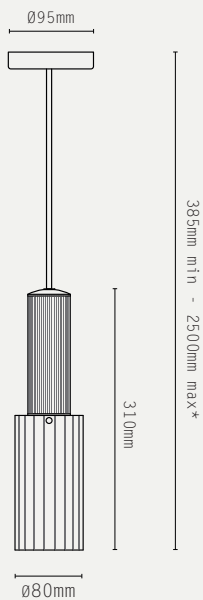

\*longer cable available at extra cost

### LIGHT SOURCE:

GU10 LAMP BASE  
(12W MAX LED ONLY / 35MM MAX  
LAMP DIAMETER)

### LAMP SUPPLIED:

1 X GU10 MR11 LED / 2700K /  
3.6W / 290 LUMENS

### DIMMABLE:

PHASE (MAINS) DIMMING (USING  
SUPPLIED LAMP)

### VOLTAGE:

240V AC (CLASS I)

### CERTIFICATIONS:

CE / UKCA

### MATERIALS:

BRASS, GLASS

### WEIGHT:

1.5 KG (APPROX)





### HANGING OPTIONS:

- 2.5M ADJUSTABLE BRAIDED CABLE  
- DROP ROD



### ADDITIONAL INFO:

DESIGNED BY WILL EARL 2019  
MADE IN ENGLAND

### METAL FINISHES:

-  ANTIQUE BRASS
-  BRONZE
-  SATIN BRASS
-  SATIN NICKEL

### GLASS OPTIONS:

-  CLEAR REEDED GLASS
-  FROSTED REEDED GLASS

### PRODUCT CODES:

FL.P80.AB.CRG - ANTIQUE BRASS / CLEAR REEDED GLASS  
FL.P80.BZ.CRG - BRONZE / CLEAR REEDED GLASS  
FL.P80.SB.CRG - SATIN BRASS / CLEAR REEDED GLASS  
FL.P80.SN.CRG - SATIN NICKEL / CLEAR REEDED GLASS

FL.P80.AB.FRG - ANTIQUE BRASS / FROSTED REEDED GLASS  
FL.P80.BZ.FRG - BRONZE / FROSTED REEDED GLASS  
FL.P80.SB.FRG - SATIN BRASS / FROSTED REEDED GLASS  
FL.P80.SN.FRG - SATIN NICKEL / FROSTED REEDED GLASS

## FLUME 80 PENDANT - IP44

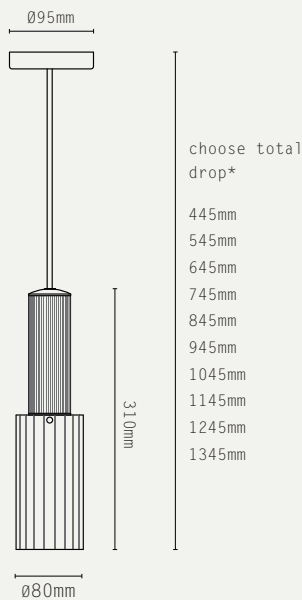

\*longer drop available at extra cost

### LIGHT SOURCE:

GU10 LAMP BASE  
(12W MAX LED ONLY / 35MM MAX  
LAMP DIAMETER)

### LAMP SUPPLIED:

1 X GU10 MR11 / 2700K / 3.6W /  
290 LUMENS

### DIMMABLE:

PHASE (MAINS) DIMMING (USING  
SUPPLIED LAMP)

### VOLTAGE:

240V AC (CLASS I)

### CERTIFICATIONS:

CE / UKCA  
IP44

### MATERIALS:

BRASS, GLASS

### WEIGHT:

1.5 KG (APPROX)





### HANGING OPTIONS:

DROP ROD AT 100MM INCREMENTS



### ADDITIONAL INFO:

DESIGNED BY WILL EARL 2019  
MADE IN ENGLAND

### METAL FINISHES:

-  ANTIQUE BRASS
-  BRONZE
-  SATIN BRASS
-  SATIN NICKEL

### GLASS OPTIONS:

-  CLEAR REEDED GLASS
-  FROSTED REEDED GLASS

### PRODUCT CODES:

FL.P80.IP.AB.CRG - ANTIQUE BRASS / CLEAR REEDED GLASS  
FL.P80.IP.BZ.CRG - BRONZE / CLEAR REEDED GLASS  
FL.P80.IP.SB.CRG - SATIN BRASS / CLEAR REEDED GLASS  
FL.P80.IP.SN.CRG - SATIN NICKEL / CLEAR REEDED GLASS

FL.P80.IP.AB.FRG - ANTIQUE BRASS / FROSTED REEDED GLASS  
FL.P80.IP.BZ.FRG - BRONZE / FROSTED REEDED GLASS  
FL.P80.IP.SB.FRG - SATIN BRASS / FROSTED REEDED GLASS  
FL.P80.IP.SN.FRG - SATIN NICKEL / FROSTED REEDED GLASS

## FLUME 80 PENDANT - 3 DROP GROUPING

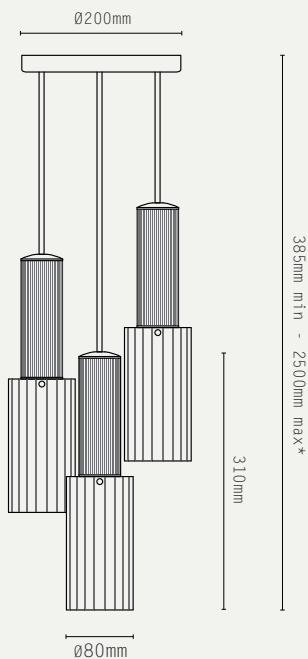

\*longer cable available at extra cost

### LIGHT SOURCE:

GU10 LAMP BASE  
(12W MAX LED ONLY / 35MM MAX  
LAMP DIAMETER)

### LAMP SUPPLIED:

3 x GU10 MR11 / 2700K / 3.6W /  
290 LUMENS

### DIMMABLE:

PHASE (MAINS) DIMMING (USING  
SUPPLIED LAMP)

### VOLTAGE:

240V AC (CLASS I)

### CERTIFICATIONS:

CE / UKCA

### MATERIALS:

BRASS, GLASS

### WEIGHT:

4.5 KG (APPROX)





### HANGING OPTIONS:

- 2,5M ADJUSTABLE BRAIDED CABLE  
- DROP ROD (ON REQUEST)



### ADDITIONAL INFO:

DESIGNED BY WILL EARL 2019  
MADE IN ENGLAND

### METAL FINISHES:

-  ANTIQUE BRASS
-  BRONZE
-  SATIN BRASS
-  SATIN NICKEL

### GLASS OPTIONS:

-  CLEAR REEDED GLASS
-  FROSTED REEDED GLASS

### PRODUCT CODES:

FL.P803.AB.CRG - ANTIQUE BRASS / CLEAR REEDED GLASS  
FL.P803.BZ.CRG - BRONZE / CLEAR REEDED GLASS  
FL.P803.SB.CRG - SATIN BRASS / CLEAR REEDED GLASS  
FL.P803.SN.CRG - SATIN NICKEL / CLEAR REEDED GLASS

FL.P803.AB.FRG - ANTIQUE BRASS / FROSTED REEDED GLASS  
FL.P803.BZ.FRG - BRONZE / FROSTED REEDED GLASS  
FL.P803.SB.FRG - SATIN BRASS / FROSTED REEDED GLASS  
FL.P803.SN.FRG - SATIN NICKEL / FROSTED REEDED GLASS

## FLUME 80 PENDANT - 6 DROP GROUPING

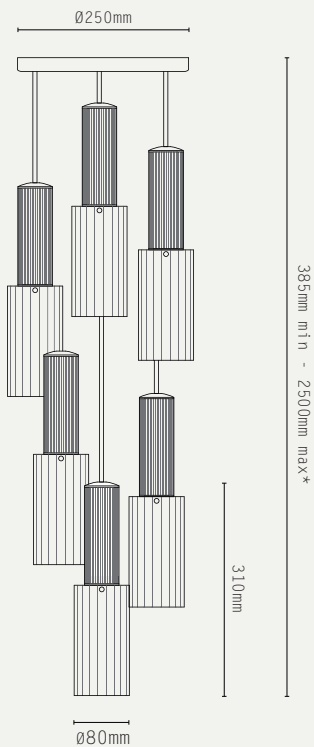

\*longer cable available at extra cost

### LIGHT SOURCE:

GU10 LAMP BASE  
(12W MAX LED ONLY / 35MM MAX  
LAMP DIAMETER)

### LAMP SUPPLIED:

6 x GU10 MR11 / 2700K / 3.6W /  
290 LUMENS

### DIMMABLE:

PHASE (MAINS) DIMMING (USING  
SUPPLIED LAMP)

### VOLTAGE:

240V AC (CLASS I)

### CERTIFICATIONS:

CE / UKCA

### MATERIALS:

BRASS, GLASS

### WEIGHT:

8.5 KG (APPROX)





### OPTIONAL ACCESSORIES:

- 2.5M ADJUSTABLE BRAIDED CABLE  
- DROP ROD (ON REQUEST)



### ADDITIONAL INFO:

DESIGNED BY WILL EARL 2019  
MADE IN ENGLAND

### METAL FINISHES:

-  ANTIQUE BRASS
-  BRONZE
-  SATIN BRASS
-  SATIN NICKEL

### GLASS OPTIONS:

-  CLEAR REEDED GLASS
-  FROSTED REEDED GLASS

### PRODUCT CODES:

FL.P806.AB.CRG - ANTIQUE BRASS / CLEAR REEDED GLASS  
FL.P806.BZ.CRG - BRONZE / CLEAR REEDED GLASS  
FL.P806.SB.CRG - SATIN BRASS / CLEAR REEDED GLASS  
FL.P806.SN.CRG - SATIN NICKEL / CLEAR REEDED GLASS

FL.P806.AB.FRG - ANTIQUE BRASS / FROSTED REEDED GLASS  
FL.P806.BZ.FRG - BRONZE / FROSTED REEDED GLASS  
FL.P806.SB.FRG - SATIN BRASS / FROSTED REEDED GLASS  
FL.P806.SN.FRG - SATIN NICKEL / FROSTED REEDED GLASS