

# HAVEN

BICYCLE CO.

## TANDEM OWNER'S MANUAL

THIS MANUAL CONTAINS IMPORTANT SAFETY INFORMATION.  
PLEASE READ AND KEEP THIS OWNER'S MANUAL FOR FUTURE REFERENCE.



F I N D   Y O U R   H A V E N

# HAVEN

BICYCLE CO.

In the interest of safe cycling you must read, understand, and follow the instructions in this manual.

This manual contains important safety, signal words such as **DANGER**, **WARNING**, **CAUTION**, **IMPORTANT**, and **NOTE** or **NOTICE**. **These are important signal words telling you to pay special attention to that text as rider safety is involved.**

**▲ This symbol will appear in most areas critical to rider safety.**

**▲ DANGER and WARNING:** Pay special attention to these words and symbols where they appear since failure to do so could result in serious injury or death to the rider or others.

**CAUTION:** If not followed these instructions could result in injury, mechanical failure or damage to the bicycle.

**NOTE or NOTICE or IMPORTANT:** These specify something that is of special interest. Read and pay close attention as your personal safety and that of your bicycle are involved.

**IMPORTANT:** Read the **BEFORE PURCHASING AND BEFORE RIDING** sections of this manual. Check that all parts are installed and working as per this manual. If you understand how the bicycle operates, you will get the best performance. When you read this manual, compare the illustrations to the bicycle. Learn the location of all the controls and parts as well as how they work. **KEEP THIS MANUAL FOR FUTURE USE AND FUTURE REFERENCE.**

**CAUTION** Before you ride the bicycle, check the brakes and all other parts of the bike. Make sure all parts, such as the saddle, brakes, handlebar, seat post, pedals, reflectors, and gears (if applicable), are assembled correctly, securely tightened and working properly. Take your first ride in a large, open, level area away from traffic. If you have a problem, consult your dealer.

## **SPECIAL SAFETY PRECAUTIONS FOR TANDEM RIDERS:**

1. Constant communication between both operators is critical for safe handling of the tandem bicycle. The steering and stopping power are under the control of the first (front) rider. The pedaling is a joint operation of both riders.
2. No more than two people should be on the tandem bicycle at one time. Both of the riders should meet the minimum leg length requirement.
3. Too often the inexperienced tandem riders use unsafe riding techniques and usually the result is a fall and possible injury. Please use caution when riding.

## **OFF ROAD CAUTION:**

The tandem bicycle is not recommended for off road use. The combination of the length of the bicycle frame and the difference in weight of the riders will cause the tandem bicycle to be unstable on rough road conditions.

Use caution when stopping. Because of the added weight, it may take longer to come to a full stop.

Make sure handlebar stem and seat posts are inserted far enough so that the minimum insertion line does not show. Tighten seatpost/stem combination for second rider securely (recommended torque for this part is 14 foot pounds).

# HAVEN

BICYCLE CO.

## C O N T E N T S

PREFACE.....	2-5
PARTS IDENTIFICATION CHART .....	6
BEFORE RIDING.....	7-9
MAINTENANCE/REPAIR.....	10-25
TROUBLESHOOTING .....	26-28
LIMITED WARRANTY .....	29-30



# HAVEN

BICYCLE CO.

## P R E F A C E

Your bike has been delivered to you fully assembled. If parts of your bike have not been installed, please consult your dealer to arrange for final assembly. **This manual contains important safety, performance and service information. Read before riding.** The purpose of this Owner's Manual is to help you use your bike safely in the manner it is intended and allow you to enjoy the benefits it offers for many years to come. **Please read this manual completely before you take the first ride on your new bicycle, and keep it for reference.**

Additional safety, performance and service information for specific components such as suspension or pedals on your bicycle, or for accessories such as helmets or lights that you purchase, may also be available. Make sure that your dealer has given you all the manufacturers' literature that was included with your bicycle or accessories.

If you have any questions or do not understand something, take responsibility for your safety and consult with your dealer or the bicycle's manufacturer.

**IMPORTANT: This manual is provided to assist you, and is not intended to be a comprehensive manual covering all aspects of assembling, maintaining, repairing or riding your bicycle. The bicycle you have purchased is a complex piece of equipment that must be properly assembled and maintained in order to be ridden safely. If you have any doubts about the assembly or your ability to properly assemble and maintain your new bicycle, you must have your bicycle assembled and maintained by a certified, professional bike mechanic.**

If you have any questions or do not understand something, take responsibility for your own safety and reach out to our team at Able Bicycle Company or consult with your local bike store or certified bicycle mechanic.



**ALWAYS WEAR A PROPERLY FITTED HELMET WHEN YOU RIDE YOUR BICYCLE. DO NOT RIDE AT NIGHT. AVOID RIDING IN WET CONDITIONS.**



**USE A HEADLIGHT, A FULL SET OF REFLECTORS, AND FOLLOW ALL RULES OF THE ROAD AND TRAFFIC CONTROL INSTRUCTIONS.**

**NOTE: Max weight of riders+luggage = 400lbs/181kg**



# HAVEN

BICYCLE CO.

## BEFORE PURCHASING

### CORRECT FRAME SIZING:

When selecting a new bicycle, the correct choice of frame size is a very important safety consideration. The ideal clearance will vary between types of bicycles and rider preference. This makes straddling the frame when off the saddle easier and safer in situations such as sudden traffic stops. Women can use a man's bicycle to determine the correct size women's model.

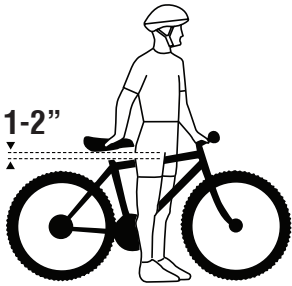

**THERE SHOULD BE A CLEARANCE OF NO LESS THAN 1-2 INCHES BETWEEN THE GROIN AREA OF THE INTENDED RIDER AND THE TOP TUBE OF THE BICYCLE, WHILE THE RIDER STRADDLES THE BICYCLE WITH BOTH FEET FLAT ON THE GROUND AND THE BICYCLE IS NOT MOVING.**



**THE SEAT POST "MINIMUM INSERTION" / "MAXIMUM HEIGHT" MARK SHOULD NOT BE VISIBLE WHEN THE SEAT POST IS INSERTED INTO THE SEAT MAST OF THE BIKE. DO NOT RAISE THE SEAT POST BEYOND THIS MARK. THE SEAT POST OR FRAME MAY BREAK DURING USE CAUSING YOU TO LOSE CONTROL AND FALL. ALWAYS CHECK TO MAKE SURE THE SEAT POST ADJUSTING MECHANISM IS TIGHTENED SECURELY BEFORE RIDING.**

### RIDING POSITION:

#### SADDLE HEIGHT

In order to obtain the most comfortable riding position and offer the best possible pedaling, correct saddle height should not allow leg strain from over-extension, and the hips should not rock from side to side when pedaling. While sitting on the bicycle with one pedal at it's lowest point, place the ball of your foot on the pedal. The correct saddle height will, as shown, allow the knee to be slightly bent in this position.

#### REACH

To obtain maximum comfort, the rider should not over extend his or her reach when riding. There should be a slight bend in the rider's elbows. Refer to the section regarding seat and seat posts to learn how to adjust the seat post height for maximum comfort, efficiency, and safe use.

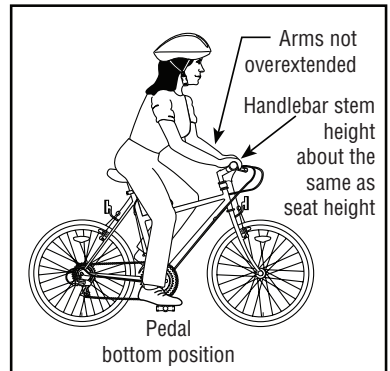

## CAUTION / WARNING

**⚠ CAUTION:** For your safety you must carefully read this manual and follow its instructions. Your bicycle may come with additional instruction sheets that cover features unique to your bike. Please ensure that you read and become familiar with their contents and retain them with this manual for future reference. Remember bicycles, in most areas, are subject to the same laws, rules, and regulations as motor vehicles. Take time to learn and follow the rules of the road.

**⚠** Always wear a CPSC approved helmet when riding your bike. Learn and follow local and state traffic use laws.

**⚠** Riding at night is discouraged due to safety concerns. If you must ride at night, always use a frame-mounted light, have reflectors on the wheels and on the frame. Lights should be used on the bicycle and the rider should wear light colored clothing. Check that the wheel reflector mounted in the spokes are clean, not broken, and securely attached.

**⚠** Any major service or adjustments on your bike not covered in this manual should be carried out by your bicycle dealer. If you wish to make adjustments yourself, this manual contains important tips on how to do it.

**⚠ CAUTION:** Any adjustments you make are entirely at your own risk. Do **NOT** use your bike for freestyle and stunt riding, jumping or competitive events. Even if you are riding a mountain bike, you should know that off-road use or any similar activities can be dangerous, and you assume the risk for personal injury, damages or losses incurred from such use. Do not ride your bike when any part is damaged or not working properly. **You must, for your safety and the safety of other users, consult your bicycle dealer for any questions on repairs or maintenance.**

**⚠ WARNING:** As with all mechanical components, the bicycle is subjected to wear and high stresses. Different materials and components react to wear or stress fatigue in different ways. As your bicycle ages, you should inspect it more frequently to look for deformed, cracked, bent, or loose components. Such conditions may lead to sudden failure. This may possibly cause injuries to the rider. If something is cracked or broken, discontinue use immediately and take the bicycle to your mechanic or store for repair or service as needed.

**⚠ ALWAYS WEAR A HELMET-IT COULD SAVE YOUR LIFE! ⚠**

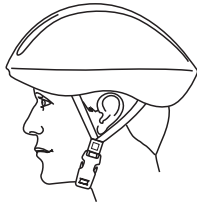

**CORRECT**  
Forehead Covered

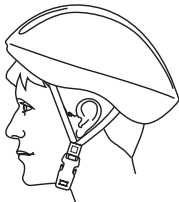

**INCORRECT**  
Forehead Exposed

A properly fitting, CPSC approved, bicycle helmet should be worn at all times when riding your bicycle. In addition, if you are carrying a passenger (only use an approved child safety seat), the passenger must also be wearing a helmet

The correct helmet should:

- be lightweight and comfortable
- have good ventilation
- cover the forehead and fit correctly as shown at left
- be securely fastened on the rider

## RESPONSIBILITY OF THE OWNER

**IMPORTANT:** Reading and following the information and instructions in this manual are essential to your ability to ride safely.

1. It is the responsibility of the owner or in the case of a younger rider the parents of the rider to be certain all assembly instructions have been followed, even if the bike has been assembled by the seller or a professional assembly company.
2. Brakes are essential to safety. Be sure they are checked and working properly before each use. Remember that any mechanical system changes condition during use and must be maintained and checked before each use.
3. Rules for bicycle use (bicycle laws) vary from location to location so be certain the rider knows and understands the rules that apply to bicycle usage in your area. Wearing a helmet and using lights and reflectors are two examples of rules which likely exist and which make sense as rider safety precautions at all times.
4. Know how to operate the bicycle and all equipment on it before first use and be certain anyone else allowed to use the bike knows how to properly and safely use the bike as well.
5. There are many different types of bicycles and often these types are designed for different uses. Make sure you know what type unit you have and do not exceed its service limitations. Be sure you check and understand the bicycle classifications set forth below, including size of the unit that is proper for the rider to insure good control during use. Riders who are too small may have control problems. Do not overload a unit with a rider that is too heavy or too large, and do not attempt to carry extra passengers, packages or loads on the bicycle. Do not attempt to use street bikes for off road riding.



**IMPORTANT: FOR YOUR SAFETY YOU MUST READ AND  
RETAIN THIS MANUAL FOR FUTURE REFERENCE.**

# HAVEN

BICYCLE CO.

## PARTS IDENTIFICATION

- |                           |                             |                            |
|---------------------------|-----------------------------|----------------------------|
| 1. Handlebar (Front)      | 16. Saddle (Front)          | 31. Seat Post (Rear)       |
| 2. Brake Lever            | 17. Seat Clamp (Front)      | 32. Seat Post Clamp (Rear) |
| 3. Handlebar Stem (Front) | 18. Seat Post (Front)       | 33. Seat Tube (Rear)       |
| 4. Headset                | 19. Seat Post Clamp (Front) | 34. Chain Stay             |
| 5. Fender (Front)         | 20. Seat Tube (Front)       | 35. Derailleur             |
| 6. Fork                   | 21. Chain                   | 36. Tire (Rear)            |
| 7. Front Disc Brake       | 22. Handlebar (Rear)        | 37. Wheel (Rear)           |
| 8. Tire (Front)           | 23. Handlebar Stem (Rear)   | 38. Spokes (Rear)          |
| 9. Wheel (Front)          | 24. Frame                   | 39. Fender (Rear)          |
| 10. Spokes (Front)        | 25. Pedal (Rear)            | 40. Rear Rack              |
| 11. Down Tube             | 26. Crank Arm (Rear)        |                            |
| 12. Pedal (Front)         | 27. Chain Wheel (Rear)      |                            |
| 13. Crank Arm (Front)     | 28. Chain Guard (Rear)      |                            |
| 14. Chain Wheel (Front)   | 29. Saddle (Rear)           |                            |
| 15. Chain Guard (Front)   | 30. Seat Clamp (Rear)       |                            |



**IMPORTANT: USE THIS DIAGRAM WHEN READING AND DISCUSSING THIS MANUAL TO HELP YOU UNDERSTAND DIRECTIONS AND INSTRUCTIONS.**



## BEFORE RIDING

**1. ⚠️ WARNING - ON AND OFF ROAD CONDITIONS:** The condition of the riding surface is very important to your safety. If the surface is wet, or has sand, leaves, small rocks or other loose debris on the surface where you plan to ride, carefully decrease the speed of the bicycle and ride with extra caution. It will take a longer time and more distance to stop. Apply the brakes sooner and with less force. Always apply the rear brake first allowing time and distance for it to take effect. Then follow by cautiously applying the front brake, in order to maintain control of the bicycle. Rapid front brake application first may cause a front pitch over or fall. Learn to use your brakes properly under controlled conditions until you learn proper braking under all road conditions.

**2. NOTICE:** State and federal regulations require a full set of reflectors. Some state and local laws may require that your bike be equipped with a warning device, such as a horn or bell and most states require a light. The manufacturer and many legal authorities **DO NOT** approve or encourage riding at night. Vision is quite limited at dawn, dusk and at night for bike riders, motorists and by-standers. If you must ride at night, take extra precautions, use front and rear lights, wear flashers on your arms, wear light-colored clothing, and plan your route to ride in well lighted areas avoiding heavy traffic areas.

**3.** When riding, **ALWAYS WEAR A CPSC APPROVED BIKE HELMET.** It may save your life. Helmets with reflective tape are also beneficial.

**4. NOTE:** Always wear shoes when riding a bicycle and avoid loose fitting clothes. Wear a cuff band or trouser clip to keep pants or other loose clothing from getting caught in the chain wheel. Long sleeves, long pants, gloves, eye protection, a CPSC approved helmet, elbow and knee pads are recommended.

**⚠️ Helmet use is required by law in many states and is always a good idea for your safety.**

**5. CAUTION: WET WEATHER WARNING:** Check your brakes frequently. The ability to stop is critical to your safety. Roads are slippery in wet weather so avoid sharp turns and allow more distance for stopping. Brakes become less efficient when wet. Leaves, loose gravel and other debris on the road can also lengthen stopping distance. If at all possible, do not ride in wet weather. Vision and control are impaired, creating a greater risk of accidents and injury.

**6. CAUTION:** A bicycle rider's best defense against accidents is to be alert to road conditions and traffic in the area. Do not wear anything that restricts your vision or your hearing. Also when riding early or late, light colored clothing as well as reflective clothing is helpful to make the rider as visible as possible.

**7.** Obey all traffic regulations. Most traffic regulations apply to bike riders as well as automobile operators. Observe all state and local traffic regulations, signs and signals. Check with your local police station on bicycle licensing and inspection, and where it is legal to ride your bike.

## BEFORE RIDING

**8.** Keep to the **RIGHT SIDE** of the road. Follow the traffic flow in a straight line close to the curb. Watch out for opening car doors and cars moving in and out of traffic. Use caution at intersections.

**9.** Never carry passengers. This is dangerous and it makes the bicycle harder to control. Never carry anything that can inhibit your ability to control the bicycle.

**10.** When riding in pairs or in larger groups, form a single line along the right side of the road. Set up a sensible distance between riders. Don't follow too closely.

**11.** Always be alert. Animals or people may dart in front of you. Give pedestrians the right-of-way. Don't ride too close to pedestrians, and don't park your bicycle where it can get in the way of foot/vehicle traffic.

**12.** Be careful at all intersections. Slow down and look both ways before crossing.

**13.** Use hand signals. Always let other drivers and pedestrians know what you are going to do. Signal 100 ft. before turning unless your hand is needed to control the bike.

**14. WARNING: NIGHT TIME OPERATION:** We do **NOT** recommend riding your bike at night. If you have an emergency that requires you to ride at night you must have proper lights and reflectors. **NEVER** ride at night without a helmet, taillight, a white front reflector, a red rear reflector, pedal reflectors and white wheel reflectors. You must be able to clearly see the surface where you are riding and be seen by others. Remember, many states have laws requiring bicycles to have lights at night.

**15.** Never hitch rides. Never hold onto moving vehicles while riding. Never stunt ride or jump on your bike.

**16. ON AND OFF ROAD OPERATION:** Avoid the following road hazards: drain grates, pot holes, ruts, soft road edges, gravel, leaves (especially when they are wet), uneven pavement, railroad crossings, manhole covers, curbs, speed bumps, puddles, and debris as all have an effect on your riding, brake function, and may result in loss of control. Adjust your speed and the way you use your brakes if you must ride in such areas.

**17.** If any components becomes loose while riding, **(STOP!!)** immediately and tighten, or bring to a mechanic for repair.

**18.** If your bicycle is equipped with a quick release feature on the front and rear hubs, seat post, stem or accessory such as a trailer, or child carrier, it should be checked for proper assembly and tightness **BEFORE** each ride.



# HAVEN

BICYCLE CO.

## B E F O R E R I D I N G

Just a minute spent before each ride can significantly improve your safety and the enjoyment of your ride. So, **EACH TIME** before you ride make a habit of performing the following safety checks:

- Stand in front of the bicycle facing rearward and hold the front wheel securely between your legs. Try to twist the handlebar and verify that they do not move. Then pull the handlebars up, trying to lift the bike. There should be no movement.
- Try to push the front wheel from side to side and confirm that it feels tight and will not wobble. Lift the front wheel up by the handlebars and strike the wheel downward with the heel of your hand to confirm that it is securely attached to the wheel. Spin the front wheel and confirm that it does not wobble or contact the fork or brake pads.
- Try to lift/push down on and twist the seat to confirm it is tight.
- Look at the connection of the pedals to the crank arm. You should not see pedal screw threads and the pedal should feel firm and be parallel to the ground.
- Apply your brake(s) and make sure they feel firm to the touch, and then spin the wheel(s). Apply the brakes. The brakes should stop the wheel(s).
- Check to be sure that the fenders and accessories (if equipped) are firmly attached and will not contact any moving parts. Make sure all reflectors are in position and not broken.

Now, put on your **BICYCLE SAFETY HELMET** and enjoy your ride. Your safety is well worth *just a minute*. Also, be sure to read and follow the warnings and instructions in this manual.



**IMPORTANT: FOR YOUR SAFETY YOU MUST READ AND RETAIN THIS MANUAL FOR FUTURE REFERENCE.**

# HAVEN

BICYCLE CO.

## MAINTENANCE / REPAIR

**Correct routine maintenance of your new bike will ensure a longer life for your bike and a safer ride for you.**

Every time you ride your bike, its condition changes. The more you ride, the more frequently maintenance will be required. We recommend you spend a little time on regular maintenance tasks. The following schedules will assist you in knowing what tasks need to be performed and how often. If you have any doubts about your abilities to accomplish these tasks, we recommend you take your bike to a professional bicycle mechanic periodically to have them done.

### Schedule 1 - Lubrication

Frequency	Component	Lubricant	How to Lubricate
Weekly	chain derailleur wheels	chain lube or light oil chain lube or light oil	brush on or squirt brush on or squirt
Monthly	derailleurs brake calipers brake levers shift levers	oil oil oil lithium based grease	oil can 3 drops from oil can 2 drops from oil can disassemble
Every Six Months	freewheel brake cables	oil lithium based grease	2 drops from oil can disassemble
Yearly	Bottom bracket pedals derailleur cables wheel bearings headset seat pillar	lithium based grease lithium based grease lithium based grease lithium based grease lithium based grease lithium based grease	Bicycle Mechanic disassemble disassemble Bicycle Mechanic Bicycle Mechanic disassemble

**Note: The frequency of maintenance should increase with use in wet or dusty conditions. Do not over lubricate - remove excess lubricant to prevent dirt build up. Never use a degreaser to lubricate your chain (WD-40™)**



**CAUTION: CONSULT YOUR BICYCLE DEALER FOR ANY QUESTIONS ON REPAIRS OR MAINTENANCE.**



# HAVEN

BICYCLE CO.

## MAINTENANCE / REPAIR

### SERVICE CHECKLIST:

Frequency	Task
Before every ride	<ul style="list-style-type: none"> <li>Make sure all folding latches are fastened securely</li> <li>Check wheel and pedal tightness</li> <li>Check tire pressure</li> <li>Check brake operation</li> <li>Check wheels for loose spokes, loose axle nuts or quick release</li> <li>Make sure all fasteners are tightened securely</li> <li>Check that all reflectors are present and securely mounted</li> </ul>
After every ride	Quick wipe down with damp cloth
Weekly	Lubrication as per schedule 1
Monthly	<ul style="list-style-type: none"> <li>Lubrication as per schedule 1</li> <li>Check derailleur adjustment</li> <li>Check brake adjustment</li> <li>Check brake and gear cable adjustment</li> <li>Check tire wear and inflation pressure</li> <li>Check wheels are true and spokes tight</li> <li>Check hub, head set and crank bearings for looseness</li> <li>Check pedals are tight</li> <li>Check handlebars are tight</li> <li>Check seat and seat post are tight and comfortably adjusted</li> <li>Check frame and fork for trueness</li> <li>Check all nuts and bolts are tight</li> <li>Check that all reflectors are securely mounted and not damaged</li> </ul>
Every six months	<ul style="list-style-type: none"> <li>Lubrication as per schedule 1</li> <li>Check all points as per monthly service</li> <li>Check and replace brake pads, if required</li> <li>Check chain for excess play or wear</li> </ul>
Yearly	Lubrication as per schedule 1



**CAUTION: CONSULT YOUR BICYCLE DEALER FOR ANY QUESTIONS ON REPAIRS OR MAINTENANCE.**



# HAVEN

BICYCLE CO.

## MAINTENANCE / REPAIR

### TOOLS REQUIRED FOR MAINTENANCE:

1. Open ended wrench or box wrenches: 8mm, 9mm, 10mm, 12mm, 13mm, 14mm, 15mm
2. Open end or pedal wrench 15mm
3. Allen key wrenches: 4mm, 5mm, 6mm, 8mm
4. Adjustable wrench
6. Standard Phillips head screwdriver
7. Standard slip joint pliers
8. Tire pump
9. Tube repair kit
10. Tire levers

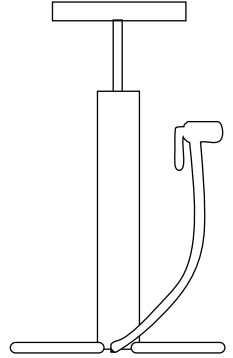

### TRAVEL TOOLS:

We suggest you take the following items with you when going on a long bike ride. Tools should be fully secured in a sturdy bag or container attached to the seat or frame of the unit during travel:

1. Spare tube
2. Patch kit
3. Pump
4. Tire levers
5. Multi-tool
6. Cell phone or change for a pay phone

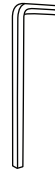
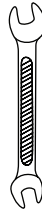

**CAUTION: CONSULT YOUR BICYCLE DEALER FOR ANY QUESTIONS ON REPAIRS OR MAINTENANCE.**



## MAINTENANCE / REPAIR

### WHEEL INSPECTION:

It is most important that wheels are kept in top condition. Properly maintaining your bicycle's wheels will help braking performance and stability when riding. Be aware of the following potential problems:

- **Dirty or greasy rims:**

**Caution:** These can render your brakes ineffective. Do not clean them with oily or greasy materials. When cleaning, use a clean rag or wash with soapy water, rinse and air dry. Don't ride while they're wet. When lubricating your bicycle, don't get oil on the rim braking surfaces.

- **Wheels not straight:**

Lift each wheel off the ground and spin them to see if they are crooked or out of true. If wheels are not straight, they will need to be adjusted. This is quite difficult and is best left to a professional bicycle mechanic.

- **Broken or loose spokes:**

Check that all spokes are tight and that none are missing or damaged.

**Caution: Such damage can result in severe instability and possibly an accident if not corrected. Again, spoke repairs are best handled by a mechanic.**

- **Loose hub bearings:**

Lift each wheel off the ground and try to move the wheel from side to side. Caution: If there is movement between the axle and the hub, do not ride the bicycle. Adjustment is required.

- **Axle nuts:**

Check that these are tight before each ride.



**CAUTION: CONSULT YOUR BICYCLE DEALER FOR ANY QUESTIONS ON REPAIRS OR MAINTENANCE.**



# HAVEN

BICYCLE CO.

## MAINTENANCE / REPAIR

### TIRE INSPECTION:

Tires must be maintained properly to ensure road holding and stability. Check the following areas:

- **Inflation:**

Ensure tires are inflated to the pressure indicated on the sidewall of the tire. Improper inflation is the biggest cause of tire failure. Due to the slightly porous nature of bicycle inner tubes, it is normal for your tires to lose pressure over time. For this reason, it is critically important to maintain the proper tire inflation on your bike. **Caution: Use a hand or foot pump to inflate tires. NEVER inflate tires with an air compressor at a gas station. This can cause the tubes to over inflate and blowout.**

- **Bead Seating:**

When inflating or refitting the tire, make sure that the bead is properly seated in the rim.

- **Tread:**

Check that the tread shows no signs of excessive wear or flat spots, and that there are no cuts or other damage.

**CAUTION: Excessively worn or damaged tires should be replaced. Use of the bicycle is strictly discouraged until worn/damaged tires are repaired or replaced.**

- **Valves:**

Make sure valve caps are fitted and that valves are free from dirt. A slow leak caused by the entry of dirt can lead to a flat tire and possibly a dangerous situation.

### RECOMMENDED TIRE PRESSURES:

The recommended pressure is molded on the sidewall of your bicycle tires.



**CAUTION: CONSULT YOUR BICYCLE DEALER FOR ANY QUESTIONS ON REPAIRS OR MAINTENANCE.**





## MAINTENANCE / REPAIR

### HOW TO FIX A FLAT TIRE: If you need to repair a tire, follow these steps:

1. Remove the wheel from the bicycle.
2. Deflate the tire completely via the valve. Loosen the tire bead by pushing it inward all the way around.
3. Press one side of the tire bead up over the edge of the rim. Note: Use tire levers, not a screwdriver, otherwise you may damage the rim.
4. Remove the tube, leaving the tire on the rim.
5. Locate the leaks and patch using a tube repair kit or replace the tube. Note: Ensure that the replacement tube size matches the size stated on the tire sidewall and that the valve is the correct type for your bicycle.
6. Match the position of the leak in the tube with the tire to locate the possible cause and mark the location on the tire.
7. Remove the tire completely and inspect for a nail, glass, etc. and remove if located. Also inspect the inside of the rim to ensure there are no protruding spokes, rust or other potential causes. Replace the rim tape which covers the spoke ends.
8. Remount one side of the tire onto the rim.
9. **Using a hand pump**, inflate the tube just enough to give it some shape.
10. Place the valve stem through the hole in the rim and work the tube into the tire.  
NOTE: Do not let it twist.
11. Using your hands only, remount the other side of the tire by pushing the edge toward the center of the rim. Start on either side of the valve and work around the rim.
12. Before the tire is completely mounted, push the valve up into the rim to make sure the tire can sit squarely in position.
13. Fit the rest of the tire, rolling the last, most difficult part on using your thumbs.  
NOTE: Avoid using tire levers as these can easily puncture the tube or damage the tire.
14. Check that the tube is not caught between the rim and the tire bead at any point.
15. **Using a hand pump**, inflate the tube until the tire begins to take shape. Check that the tire bead is evenly seated all the way around the rim. When properly seated, fully inflate the tire to the pressure marked on the sidewall.
16. Replace the wheel into the frame checking that all gears, brakes and quick release levers are properly adjusted.



**CAUTION: CONSULT YOUR BICYCLE DEALER FOR ANY QUESTIONS ON REPAIRS OR MAINTENANCE.**



## MAINTENANCE / REPAIR

### DISC BRAKES:

**We suggest that if your bike comes equipped with a disc brake that you consult a professional bicycle mechanic for any adjustments or repair needed for this brake.**

### SAFETY PRECAUTIONS

1. Adjust the inner cable so that the protruding length is less than 20mm. If the protruding length is any longer, the end of the cable may become stuck in the rotor, which could cause the wheel to lock and the bicycle could fall forward causing injuries.
2. The calipers and rotor will become hot when the brakes are operated, so do not touch them while riding or immediately after dismounting from the bicycle, you may get burned. Check that the brake components have cooled down before attempting to adjust the brakes.
3. Always make sure that the front and rear brakes are working correctly before you ride the bicycle.
4. Before riding the bicycle, check that the pad thicknesses are 0.5mm or more.
5. If noise occurs when the brakes are operated, it may indicate that the brake pads have worn down to their usage limit. After checking that the brake system has cooled down sufficiently, check the brake pad thickness. Replace the brake pads if the wear indicators are visible.
6. Be careful not to allow any oil or grease to get onto the rotor and brake pads, otherwise the brakes may not work correctly.
7. Check the brake cable for rust and fraying, and replace the cable immediately if such problems are found. If this is not done, the brakes may not work correctly.
8. The required braking distance will be longer during wet weather. Reduce your speed and apply the brakes early and gently.

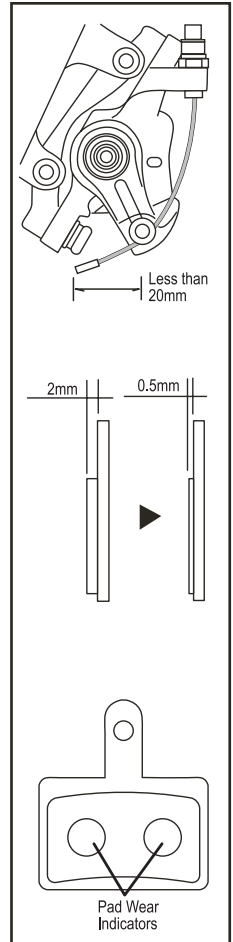

**CAUTION: CONSULT YOUR BICYCLE DEALER FOR ANY QUESTIONS ON REPAIRS OR MAINTENANCE.**



# HAVEN

BICYCLE CO.

## MAINTENANCE / REPAIR

### **DISC BRAKES:** *continued*

9. If the road surface is wet, the tires will skid more easily. If the tires skid, you may lose control of the bicycle. To avoid this, reduce your speed and apply the brakes gently.
10. Check that the quick release lever is on the right side (the opposite side to the rotor). If the quick release lever is on the same side as the rotor, there is a danger that the lever may interfere with the rotor causing a sudden stop, which may result in a serious accident. Make sure that it does not interfere by rotating the wheel and making sure it rotates freely. Make sure wheel is securely tightened to forks.
11. It is important to completely understand the operation of your bicycle's brake system. Improper use of your brake system may result in loss of control or an accident, which could lead to severe injury. Because each bicycle may handle differently be sure to learn proper braking technique (including brake lever pressure and bicycle control characteristics) and operation of your bicycle. This can be done by consulting a professional bicycle mechanic and referring to the disk brake instruction sheet included with your bike. This can also be done by practicing your braking technique in a safe area before hitting the trails.

**CAUTION: Disc brakes have a burn-in period, and the braking force will gradually increase as the burn-in period progresses. Make sure that you are aware of any such increases in braking force when using the brakes during the burn-in period. The same thing will happen when the brake pads or rotor are replaced.**



**CAUTION: CONSULT YOUR BICYCLE DEALER FOR ANY QUESTIONS ON REPAIRS OR MAINTENANCE.**



## MAINTENANCE / REPAIR

### DISC BRAKES: *continued*

If the brake cable is not connected at the brake lever, line up brake barrel slot with brake lever slot before installing the cable. Slide the head of the brake cable into the brake lever per the diagram. Thread the cable through the slot in the brake lever so the cable end rests squarely in the adjusting barrel. Turn the adjusting barrel to close. (See pg. 20)

If the brake cable is disconnected at the disc caliper, thread the brake wire through the adjustment barrel, loosen the cable anchor bolt until you can see a hole through the anchor bolt for the cable wire to attach. Thread the cable wire through the cable anchor and tighten by hand.

**Centering brake** - First determine if the wheel is centered. Look at the space between the tire and the frame on either side. If it is not even, loosen the wheel axle nuts and center the wheel, then proceed to center the brake.

If the brake is not centered, look at the disc brake caliper for centering adjustment screws at the center of the brake pad on either side. Looking down into the brake where the brake pads contact the disc rotor, determine which side needs to move away or towards the disc. Turn the centering adjustment screws so that there is about 1/32 of an inch of clearance on either side of the disc rotor. Spin the front wheel and listen for any rubbing noise or excess friction. Repeat the steps until the brake is centered.

### **Brake is correctly adjusted when:**

- The brake pads do not drag on the rotor when the brake is open.
- When the brake is applied, the brake pads contact the rim before the brake lever reaches about 1/3 of the way to the handlebar.

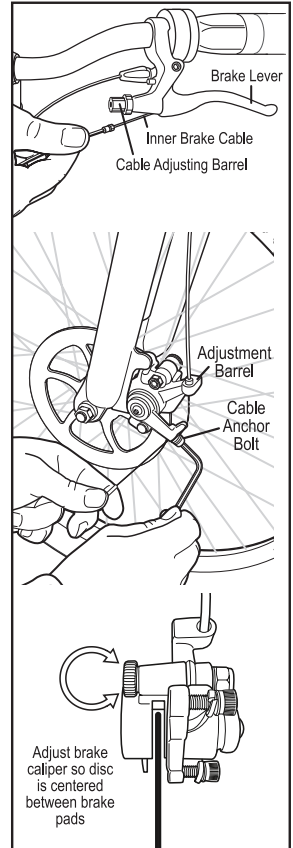

**CAUTION: CONSULT YOUR BICYCLE DEALER FOR ANY QUESTIONS ON REPAIRS OR MAINTENANCE.**



## M A I N T E N A N C E / R E P A I R

### **DISC BRAKES:** *continued*

After adjusting the brake, reinspect the brake pads, centering, and brake lever travel. If the brake pads are no longer square to the rim, repeat brake pad adjustments. Be sure that the brake pads return to a centered position by spinning the wheel and listening for the brake pad rubbing the rotor on either side. Readjust as needed. Check that the brake cable tension allows the brake lever about 1/3 of the travel before the brake pads contact the rotor. If the cable has stretched or slipped, readjust brake cable tension by loosening the cable anchor bolt and pulling more cable through the anchor or use the brake adjustment barrel for fine tuning the brake cable tension.



**WARNING! DISC GETS HOT! SEVERE INJURY COULD RESULT FROM CONTACT WITH THE HOT DISC. ALLOW DISC TO COOL COMPLETELY BEFORE TOUCHING.**



**CAUTION: CONSULT YOUR BICYCLE DEALER FOR ANY QUESTIONS ON REPAIRS OR MAINTENANCE.**



## MAINTENANCE / REPAIR

### DERAILLEUR SYSTEMS:

The derailleur system consists of the rear derailleur, the shift lever, and the derailleur control cables, all of which must function correctly for smooth gear shifting to occur. There are several different types of derailleur systems but all operate using similar principles. Your new bicycle is fitted with an “index” system (e.g. SIS) which links each different gear position to a positive click mechanism in the shifter, and makes shifting simple and precise.

### INSPECTION:

The operation of the derailleur system should be checked at the start of each ride and thoroughly checked at least every month.

Check the operation of the derailleur first. The rear derailleur should shift the chain cleanly from one cog to the next without hesitation. Each notched position in the shifter equates to a new gear position. After shifting, the rear derailleur should not rub on the chain. The derailleur should never cause the chain to fall off the inner or outer freewheel cogs. Derailleur control cables are a critical component that must be well maintained for accurate shifting performance. Check them for any sign of rust, fraying, kinks, broken strands, and any damage to the cable housing. If you find any problems, the cables or other involved components should be evaluated as it may need replacing before you ride.

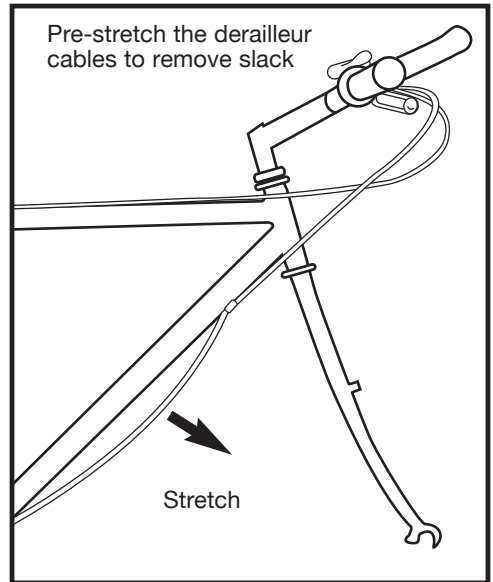

PLEASE CONSULT YOUR BICYCLE DEALER FOR  
ANY QUESTIONS ON REPAIRS OR MAINTENANCE.



## MAINTENANCE / REPAIR

### REAR DERAILLEUR ADJUSTMENT:

The Low Gear Adjustment Screw (A) determines how far the rear derailleur will travel toward the wheel of the bicycle, while the High Gear Adjustment Screw (B) determines how far the cage will travel toward the frame.

1. Shift the rear shifter to the largest number indicated, disconnect the rear derailleur cable from the cable anchor bolt and place the chain on the smallest sprocket.
2. Adjust the High Gear Adjustment Screw (B) so the chain and the smallest sprocket are lined up vertically. Remove any slack in the cable by pulling it taut, then re-connect the cable and tighten the cable anchor bolt securely.
3. Some derailleurs have an SIS Cable Adjuster. Use the adjusting barrel and turn clockwise to move the derailleur outboard - away from the wheel - while turning it counter-clockwise will direct the chain inboard - towards the wheel.
4. Shift the chain onto the largest sprocket; adjust the Low Gear Adjustment Screw (A) so the chain and the largest cog are lined up vertically. If you are unable to get the chain to the largest cog, turning the Low Gear Adjustment Screw (A) counter-clockwise will enable the chain to move towards the wheel.
5. Shift through the gears ensuring each gear is achieved quietly and without hesitation.

**NOTE:** It may take several adjustments to achieve the desired positioning. Please refer to the troubleshooting section for more assistance. Check to be sure how the components on your bike function.

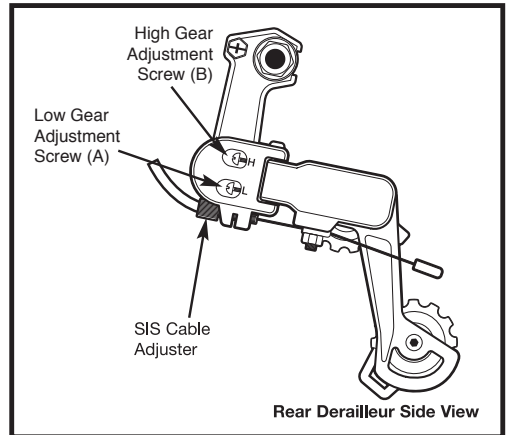

Rear Derailleur Side View



PLEASE CONSULT YOUR BICYCLE DEALER FOR  
ANY QUESTIONS ON REPAIRS OR MAINTENANCE.



## MAINTENANCE / REPAIR

### DERAILLEUR LUBRICATION:

All the pivoting points of the derailleur should be lubricated with light oil at least every month. Be sure to wipe off any excess oil to prevent attraction of dirt into the mechanisms. The shifting cables should be cleaned and re-coated with a thin layer of grease every six months, or whenever new cables are being installed.

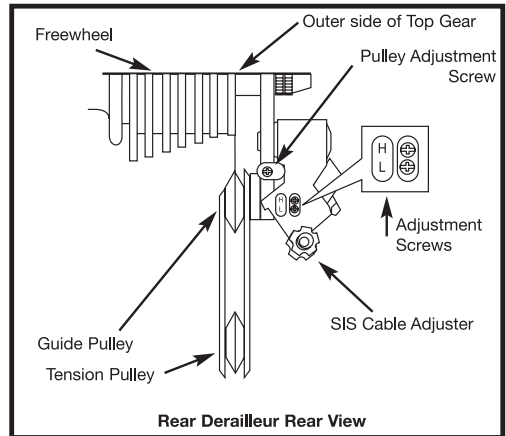

### FREEWHEEL INSPECTION:

Like the chain, the freewheel must be kept clean and well lubricated using light oil in small quantities. If the chain has become worn and needs replacing, then it is likely that the freewheel will also have become worn and should be carefully checked and also be replaced. Take the chain off the freewheel and rotate it with your hand. If you hear a grinding noise or the freewheel stops suddenly after spinning it, it may need adjustment or replacement. Such action is beyond the scope of this manual and you should consult your bicycle dealer.

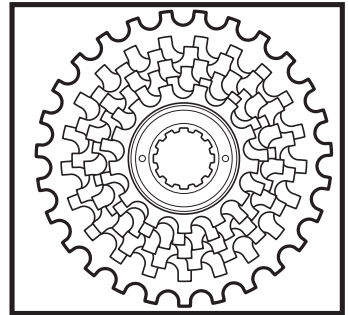

PLEASE CONSULT YOUR BICYCLE DEALER FOR  
ANY QUESTIONS ON REPAIRS OR MAINTENANCE.





## M A I N T E N A N C E / R E P A I R

**PEDAL INSPECTION:** Pedals should be inspected every month, taking note of the following areas:

- Check that the pedals are tightened securely against the crank arm. If pedals are allowed to become loose, they will not only be dangerous to the rider but will also cause irreparable damage to the mating threads of the cranks.
- Check that pedal bearings are properly functioning. Move the pedals up and down, and right to left, and also rotate them by hand. If you detect any looseness or roughness in the pedal bearings then lubrication or replacement is required. Check your pedals to see if adjustment is possible to correct the looseness.
- Ensure that the front and rear pedal reflectors on each pedal are clean, not cracked, and securely fitted.



**WARNING! Never ride with loose pedals. Improperly installed or tightened pedals can work loose, damaging the bicycle and causing possible serious injury or death to the rider.**



**Always wear solid, well-constructed shoes while riding.**



**IMPORTANT: FOR YOUR SAFETY YOU MUST READ AND RETAIN THIS MANUAL FOR FUTURE REFERENCE.**



**PLEASE CONSULT YOUR BICYCLE DEALER FOR ANY QUESTIONS ON REPAIRS OR MAINTENANCE.**



## M A I N T E N A N C E / R E P A I R

**PEDAL LUBRICATION AND ADJUSTMENT:** Many pedals cannot be disassembled to allow access to the internal bearings and axle. However, it is usually possible to inject a little oil onto the inside bearings, and this should be done every six months. If the pedal is the type that can be fully disassembled, then the bearings should be removed, cleaned and greased every six to twelve months. Because of the wide variety of pedal types and their internal complexity, disassembly procedures are beyond the scope of this manual and further assistance should be sought from a professional bicycle mechanic.

**PEDAL ATTACHMENT - Note:** The right and left pedals of a bicycle each have a different thread and are not interchangeable. Never force a pedal into the incorrect crank arm. Check for the right (R) and left (L) letters on each pedal bolt end. Not all crank arms are marked but the right pedal crank arm is on the right side of the bike with a rider in normal riding position and the left crank arm is located on the left side of the bike. Match the appropriate pedal to each crank (right to right and left to left) for assembly. Insert the correct pedal into the crank arm and begin to turn the thread with your fingers only. When the axle is screwed in substantially all the way then securely tighten using a 15mm narrow open-ended wrench so that the shoulder of the pedal spindle is securely tightened against the crank arm. If removing a pedal, remember that the right pedal axle must be turned counter clockwise, i.e. the reverse of when fitting.

If replacing the original pedals with a new set, make sure the size and the axle thread is compatible with the cranks on your bicycle.

**NOTE:** Never try and force a pedal with the wrong thread size into a bicycle crank. If the pedal is too loose or too tight, it is the wrong pedal and might come loose in use.



PLEASE CONSULT YOUR BICYCLE DEALER FOR  
ANY QUESTIONS ON REPAIRS OR MAINTENANCE.



## MAINTENANCE / REPAIR

### CHAIN INSPECTION:

The chain on your bicycle must be kept clean, rust free and frequently lubricated in order to have the best possible performance when riding and extend its life as long as possible. It will require replacement if it stretches, wears, breaks, or causes inefficient gear shifting due to excessive dirt or debris embedded in the chain. Make sure that there are no stiff links; they must all move freely to seat and shift properly.

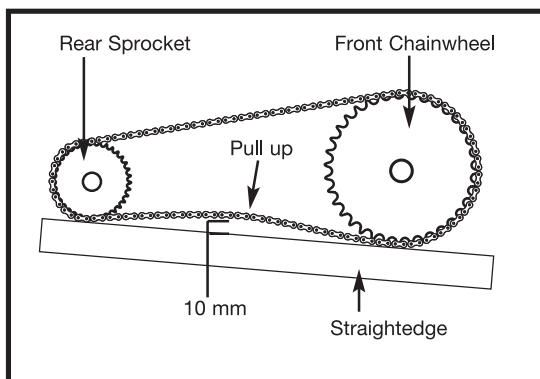

### CHAIN LUBRICATION:

The chain should be lubricated with light oil at least every month, or after use in wet, muddy, or dusty conditions. Take care to clean the chain of debris before lubrication. After lubrication, wipe off excess oil. **NOTE:** Do not get oil on the tires or rim braking surfaces.

### CHAIN ADJUSTMENT AND REPLACEMENT:

On derailleur geared bicycles, the rear derailleur automatically tensions the chain. To adjust the chain on a single speed (non-derailleur geared) bicycle:

1. Loosen the rear axle nuts (and coaster brake arm clip if fitted) and move the wheel forward to loosen, or backward to tighten the chain, in the frame.
2. When correctly adjusted, the chain should have approximately 10mm of vertical movement when checked in the center between the chainwheel and rear sprocket.

Chains require a special tool to fit and remove damaged chain links, or to change the length.

**We recommend that you go to your bicycle dealer to replace or change the length of your chain. They will have the special tools required to perform the repairs correctly.**



PLEASE CONSULT YOUR BICYCLE DEALER FOR  
ANY QUESTIONS ON REPAIRS OR MAINTENANCE.



## TROUBLESHOOTING

<b>Problem</b>	<b>Possible Cause</b>	<b>Remedy</b>
Gear shifts not working properly	<ul style="list-style-type: none"> <li>- Derailleur cables sticking/ stretched/damaged</li> <li>- Rear derailleur not adjusted properly</li> <li>- Indexed shifting not adjusted properly</li> </ul>	<ul style="list-style-type: none"> <li>- Lubricate/tighten/clean replace cables</li> <li>- Adjust derailleur</li> <li>- Adjust indexing</li> <li>- Seek advice from your dealer</li> </ul>
Slipping chain	<ul style="list-style-type: none"> <li>- Excessively worn/chipped chainring or freewheel sprocket teeth</li> <li>- Chain worn/stretched</li> <li>- Stiff link in chain</li> <li>- Non compatible chain/chainring/ freewheel</li> </ul>	<ul style="list-style-type: none"> <li>- Replace chainring and sprockets</li> <li>- Replace chain</li> <li>- Lubricate or replace master link</li> <li>- Seek advice from your dealer</li> </ul>
Chain jumping off freewheel sprocket or chainring	<ul style="list-style-type: none"> <li>- Chainring out of true</li> <li>- Chainring loose</li> <li>- Chainring teeth bent or broken</li> <li>- Rear derailleur side-to-side travel out of adjustment</li> </ul>	<ul style="list-style-type: none"> <li>- Re-true if possible, or replace</li> <li>- Tighten mounting bolts</li> <li>- Repair or replace chainring/set</li> <li>- Adjust derailleur travel</li> </ul>
Constant clicking noises when pedaling	<ul style="list-style-type: none"> <li>- Stiff chain link</li> <li>- Loose pedal axle/bearings</li> <li>- Loose bottom bracket axle/ bearings</li> <li>- Bent bottom bracket or pedal axle</li> <li>- Loose crankset</li> </ul>	<ul style="list-style-type: none"> <li>- Lubricate chain / Adjust chain link</li> <li>- Adjust bearings/axle nut</li> <li>- Adjust bottom bracket</li> <li>- Replace bottom bracket axle or pedals</li> <li>- Tighten crank bolts</li> </ul>
Grinding noise when pedaling	<ul style="list-style-type: none"> <li>- Pedal bearings too tight</li> <li>- Bottom bracket bearings too tight</li> <li>- Chain fouling derailleurs</li> <li>- Derailleur jockey wheels dirty/binding</li> </ul>	<ul style="list-style-type: none"> <li>- Adjust bearings</li> <li>- Adjust bearings</li> <li>- Adjust chain line</li> <li>- Clean and lubricate jockey wheels</li> </ul>

## TROUBLESHOOTING

<b>Problem</b>	<b>Possible Cause</b>	<b>Remedy</b>
Freewheel does not rotate	- Freewheel internal pawl pins are jammed	- Lubricate. If problem persists, replace freewheel
Brakes not working effectively	- Brake pads worn down - Brake pads/rim greasy, wet or dirty - Brake cables are binding/ stretched/damaged - Brake levers are binding - Brakes out of adjustment	- Replace brake pads - Clean pads and rim - Clean/adjust/replace cables - Adjust brake levers - Center brakes
When applying the brakes they squeal/ squeak	- Brake pads worn down - Brake block toe-in incorrect - Brake pads/rim dirty or wet - Brake arms loose	- Replace pads - Correct block toe-in - Clean pads and rim - Tighten mounting bolts
Knocking or shuddering when applying brakes	- Bulge in the rim or rim out of true - Brake mounting bolts loose - Brakes out of adjustment - Fork loose in head tube	- True wheel or take to a bike shop for repair - Tighten bolts - Center brakes and/or adjust brakeblock toe-in - Tighten headset
Wobbling Wheel	- Axle broken - Wheel out of true - Hub comes loose - Headset binding - Hub bearings collapsed - QR mechanism loose	- Replace axle - True wheel - Adjust hub bearings - Adjust headset - Replace bearings - Adjust QR mechanism
Steering not accurate	- Wheels not aligned in frame - Headset loose or binding - Front forks or frame bent - Stem wedge bolt not tight	- Align wheels correctly - Adjust/tighten headset - Take bike to a bike shop for possible frame realignment - Tighten stem bolt

## TROUBLESHOOTING

<b>Problem</b>	<b>Possible Cause</b>	<b>Remedy</b>
Frequent punctures	<ul style="list-style-type: none"><li>- Inner tube old or faulty</li><li>- Tire tread/casing worn</li><li>- Tire unsuited to rim</li><li>- Tire not checked after previous puncture</li><li>- Tire pressure too low</li><li>- Spoke protruding into rim</li></ul>	<ul style="list-style-type: none"><li>- Replace Inner tube</li><li>- Replace tire</li><li>- Replace with correct tire</li><li>- Remove sharp object embedded in tire</li><li>- Correct tire pressure</li><li>- File down spoke</li></ul>
The power indicator on meter flashes	<ul style="list-style-type: none"><li>- Battery running low</li></ul>	<ul style="list-style-type: none"><li>- Charge the battery</li></ul>
Abnormal motor noise	<ul style="list-style-type: none"><li>- Broken motor gear or broken hall sensor</li></ul>	<ul style="list-style-type: none"><li>- Replace the motor</li></ul>
Display can not turn on	<ul style="list-style-type: none"><li>- Broken controller</li></ul>	<ul style="list-style-type: none"><li>- Replace the controller</li></ul>
Battery can not be charged	<ul style="list-style-type: none"><li>- Battery failure or poor connection at charging port</li><li>- Broken charger</li></ul>	<ul style="list-style-type: none"><li>- Replace the battery</li><li>- Replace the charger</li></ul>
No motor assistance during ride	<ul style="list-style-type: none"><li>- Broken cadence sensor</li></ul>	<ul style="list-style-type: none"><li>- Replace the cadence sensor</li></ul>

# HAVEN

BICYCLE CO.

## LIMITED WARRANTY

This Limited Warranty extends only to the original retail purchaser, who must produce proof of purchase in order to validate any claim. This warranty is not transferable to anyone else.

### **What does this Limited Warranty cover?**

This warranty covers all parts of the bicycle to be free of defects in workmanship and materials. It does not cover abuse, misuse, or alterations.

### **What must you do to keep the Limited Warranty in effect?**

This warranty is effective only if:

- The bicycle is completely and correctly assembled and maintained.
- The bicycle is used under normal conditions for its intended purpose, by a person that properly fits and is capable of controlling the bicycle.
- The bicycle receives all necessary service maintenance and adjustments.

### **What is not covered by this Limited Warranty?**

This warranty does not include labor and transportation charges. The bicycle is designed for general transportation and recreational use only. This warranty does not cover normal wear and tear, paint, rust, normal maintenance items, personal injury, or any damage, failure, or loss that is caused by accident, improper assembly, maintenance, adjustment, storage, or use of the bicycle.

### **This Limited Warranty will be VOID if the bicycle is ever:**

- Used in any competitive sport.
- Used for stunt riding, jumping, aerobatics or similar activity.
- Installed with a non-standard motor or modified in any other way.
- Ridden by more than one person at a time.
- Rented or used for commercial purposes.
- Used in a manner contrary to the instructions in this Owner's Manual. Haven Bicycles Co. will not be liable for incidental or consequential loss or damage, due directly or indirectly from use of this product.

# HAVEN

BICYCLE CO.

## LIMITED WARRANTY

### **For how long does this Limited Warranty last?**

The frame is warranted for the usable life of the bicycle. Haven Bikes will replace the frame at no charge, should it fail in any weld point when the cycle has been used in a normal manner, and determined by our inspection Haven Bikes will also replace the bicycle fork if it should fail at any weld point.

You must receive prior authorization from Haven Bicycle Company's Customer Service, before returning any product or parts. All components are warranted against defects for six months from the date of purchase when properly assembled and used in a normal manner.

### **What will Haven Bicycles do?**

We will replace, without charge to you, any frame, fork, or component found to be defective by Haven Bicycle Company. CONSUMER MUST PAY ALL LABOR AND TRANSPORTATION CHARGES CONNECTED WITH THE REPAIR OR WARRANTY WORK.

### **How do you get service?**

If any part of your bicycle should fail to meet your expectations, first contact an authorized Haven Bicycle retailer or distributor to initiate a warranty claim. All warranty claims must be submitted by contacting the Haven Bicycle Company Customer Service Department at 1-973-543-2599 or [info@havenbikes.com](mailto:info@havenbikes.com).

### **What rights do you have?**

This limited warranty gives you specific legal rights. You may also have other rights which vary from State to State.







HAVENBIKES.COM

INFO@HAVENBIKES.COM



@HAVENBIKES

#HAVENBIKES



FIND YOUR HAVEN

05.21