

**PCA-2264  
WINCH SUPPORT FOR VERTICAL PULLING**

**USER MANUAL**

*© 2019 Portable Winch Co. – All rights reserved – Printed in Canada*

# PCA-2264

## WINCH SUPPORT FOR VERTICAL PULLING

**User Manual**  
**READ CAREFULLY**

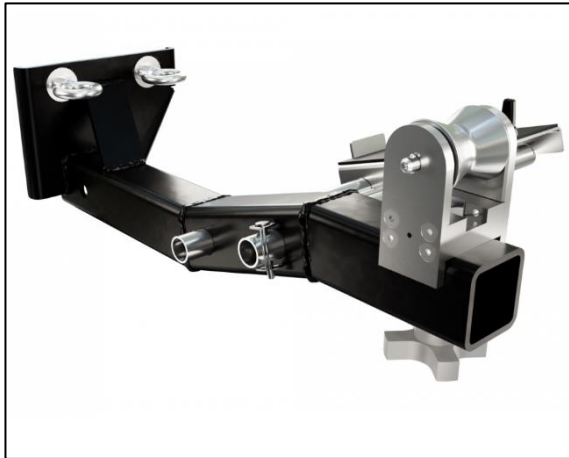

Portable Winch Co. thanks you for your confidence and congratulates you on the purchase of the **Winch support for vertical pulling PCA-2264**.

The **Winch support for vertical pulling** is composed of three main elements:

- A : Frame
- B : Adjustable shelf
- C : Redirect pulley

If any of the items are missing, please contact your

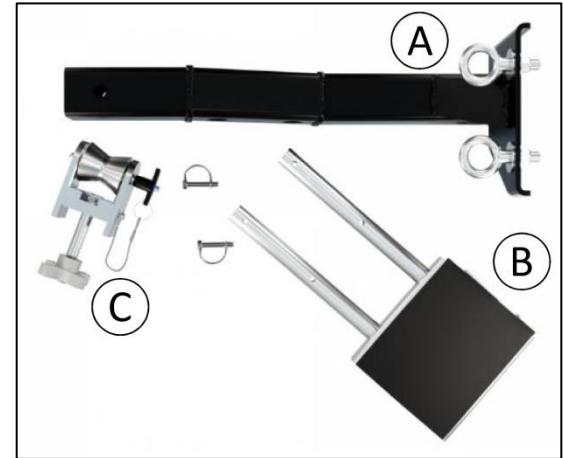

authorized dealer.

The **Winch support for vertical pulling** can be anchored to different accessories depending on the available anchor point and the work to be done. All are sold separately.

Refer to the **anchors chart** on the following page to find your situation and to know the installation and operating instructions.

**⚠ ATTENTION** IN ORDER TO USE THIS PRODUCT SAFELY, IT IS IMPORTANT THAT **ALL USERS READ THIS MANUAL CAREFULLY**.

**⚠ WARNING** NEVER ATTEMPT TO LIFT MORE THAN THE RATED LIFTING CAPACITY OF THE WINCH IN SINGLE LINE. REFER TO THE USER'S MANUAL FOR THE WINCH MODEL USED.

**⚠ WARNING** PERFORM A TEST PULL WITH A LIGHT LOAD IN ORDER TO ASSES THE STABILITY OF THE EQUIPMENT.

**⚠ ATTENTION** AFTER PULLING FOR A FEW SECONDS, RELEASE THE TENSION AND CHECK THE SOLIDITY OF THE INSTALLATION.





# PCA-2264

## WINCH SUPPORT FOR VERTICAL PULLING

**User Manual**  
**READ CAREFULLY**

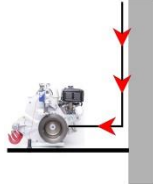
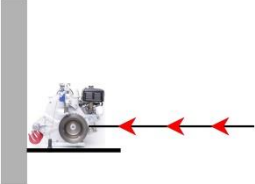
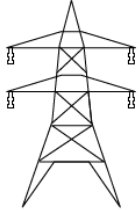

### ANCHORS CHART

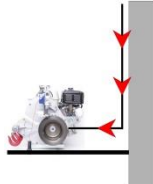
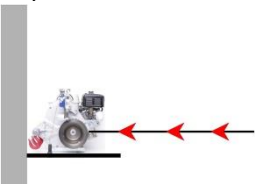



TYPE OF ANCHOR POINT	ANCHORING ACCESSORY TO BE USED TO ATTACH PCA-2264 SUPPORT	WINCH POSITION AND DESIRED ROPE DIRECTION	REFERENCE
<p>Cylindrical shape (tree, pole, etc.)</p> 	<p><b>PCA-1263</b> Winch anchor system for trees and poles.</p> 	<p>The winch faces the anchoring. The rope comes from the top towards the winch (vertical).</p> 	<p>Installation no. 1 (page 5)</p>
		<p>The winch faces the load. The rope is directly in line with the winch (horizontal).</p> 	<p>Installation no. 2 (page 6)</p>
<p>Pylon (with 'V' shaped legs at 90°)</p> 	<p><b>PCA-1806</b> Pylon mount winch anchor.</p> 	<p>The winch faces the anchoring. The rope comes from the top towards the winch (vertical).</p> 	<p>Installation no. 3 (page 7)</p>
		<p>The winch faces the load. The rope is directly in line with the winch (horizontal).</p> 	<p>Installation no. 4 (page 8)</p>

# PCA-2264

## WINCH SUPPORT FOR VERTICAL PULLING

**User Manual**  
**READ CAREFULLY**

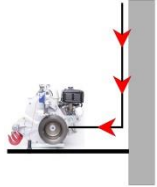
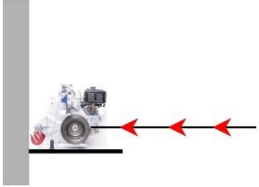

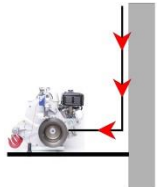
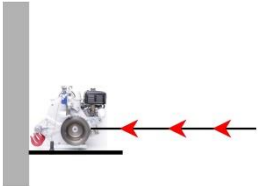
TYPE OF ANCHOR POINT	ANCHORING ACCESSORY TO BE USED TO ATTACH PCA-2264 SUPPORT	WINCH POSITION AND DESIRED ROPE DIRECTION	REFERENCE
<p>Vehicle</p> 	<p><b>PCA-1267 ou PCA-1501</b> Square tube for trailer hitch.</p> 	<p>The winch faces the anchoring. The rope comes from the top towards the winch (vertical).</p> 	<p>Installation no. 5 (page 9)</p>
		<p>The winch faces the load. The rope is directly in line with the winch (horizontal).</p> 	<p>Installation no. 6 (page 10)</p>
	<p><b>PCA-1266</b> Heck-Pack anchoring system with adaptor for 50 mm towing balls.</p> 	<p>The winch faces the anchoring. The rope comes from the top towards the winch (vertical).</p> 	<p>Installation no. 7 (page 11)</p>
		<p>The winch faces the load. The rope is directly in line with the winch (horizontal).</p> 	<p>Installation no. 8 (page 12)</p>

# PCA-2264

## WINCH SUPPORT FOR VERTICAL PULLING

**User Manual**  
**READ CAREFULLY**

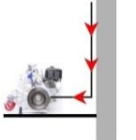

	Installation no. 1 - The winch faces the anchoring. The rope comes from the top towards the winch (vertical).		
	Accessories used		
	A	PCA-1263 Winch anchor system for <b>trees and poles</b>	
	B	PCA-2264 Winch support for vertical pulling	

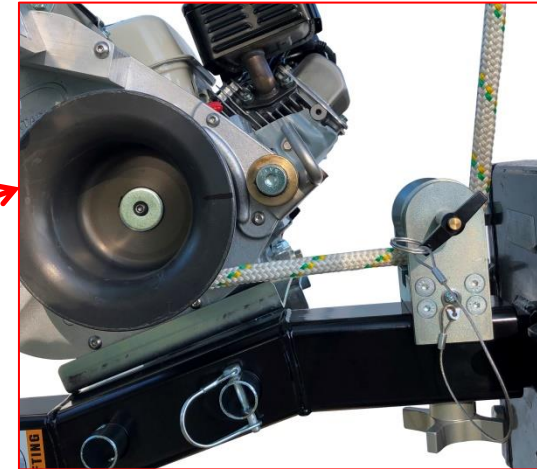
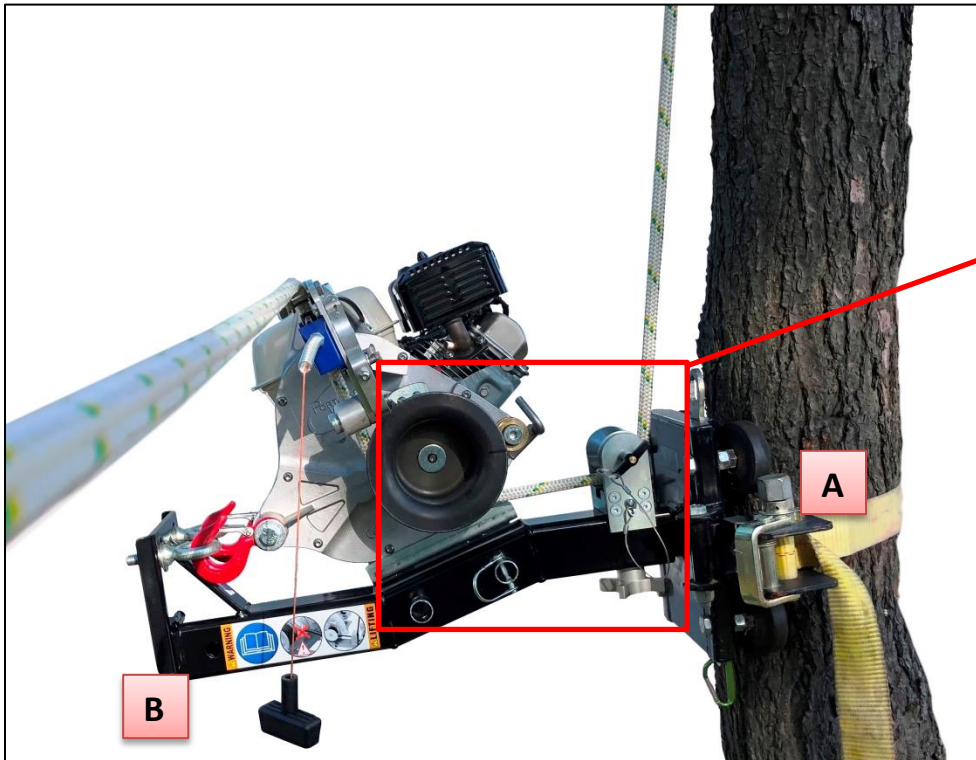

**⚠ ATTENTION** **DO NOT** GO OVER THE ROPE ENTRY PULLEY OF THE WINCH WITH THE ROPE AS IT WILL CREATE FRICTION AND WILL REDUCE LIFTING CAPACITY. **GO UNDER THE ROPE ENTRY PULLEY OF THE WINCH.** IN THIS CASE, THE ROPE ENTRY PULLEY OF THE WINCH WILL NOT BE USED.

# PCA-2264

## WINCH SUPPORT FOR VERTICAL PULLING

**User Manual**  
**READ CAREFULLY**



	Installation no. 2 - The winch faces the load. The rope is directly in line with the winch (horizontal).	
	Accessories used	
	A	PCA-1263 Winch anchor system for <b>trees and poles</b>
	B	PCA-1332 Pivoting anchor for vertical pull support
C	PCA-2264 Winch support for vertical pulling	

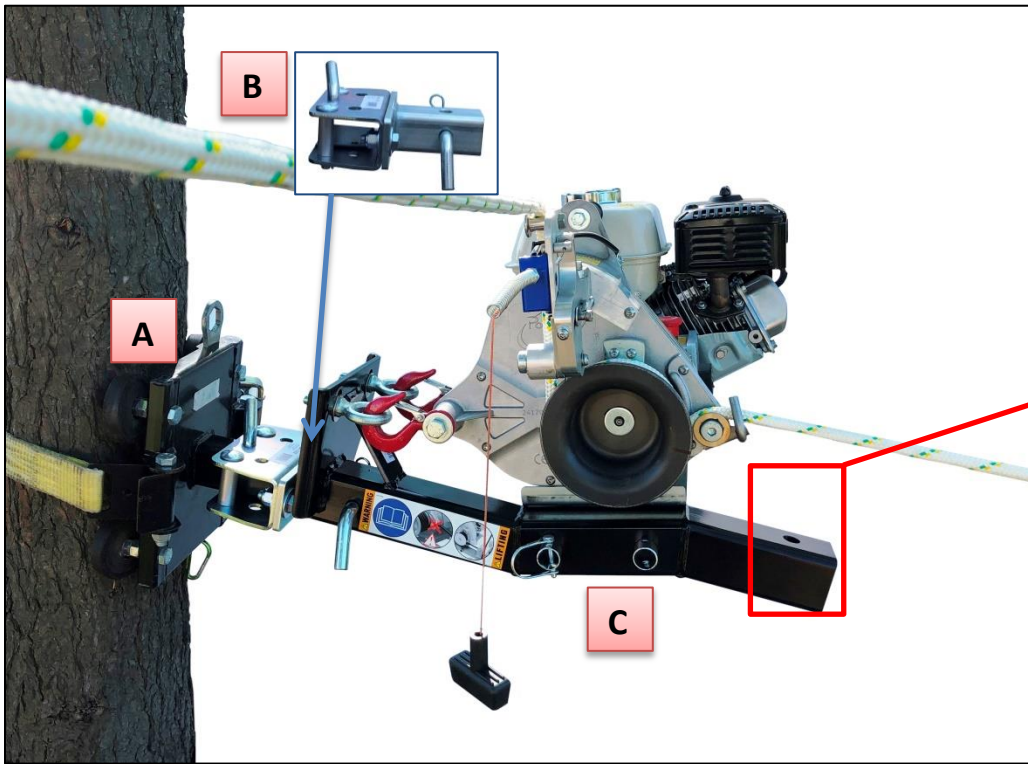
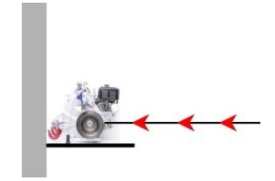

IN THIS SITUATION,  
**DO NOT USE THE REDIRECT PULLEY**  
Supplied with the  
Winch support for  
vertical pulling.

**⚠ ATTENTION** WHEN USED IN DIRECT LINE, THE PIVOTING ANCHOR FOR VERTICAL PULL SUPPORT (PCA-1332) MUST BE FIXED TO THE WINCH SUPPORT FOR VERTICAL PULL (PCA-2264). THIS ANCHOR (SOLD SEPARATELY) WILL ALLOW THE WINCH TO ALIGN WITH THE LOAD.

**⚠ ATTENTION** PUT THE ROPE ON THE WINCH ENTRY PULLEY.

# PCA-2264

## WINCH SUPPORT FOR VERTICAL PULLING

**User Manual**  
**READ CAREFULLY**

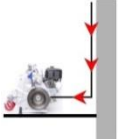

	Installation no. 3 - The winch faces the anchoring. The rope comes from the top towards the winch (vertical).		
	Accessories used		
	A	PCA-1806	
B	PCA-2264	Winch support for vertical pulling	

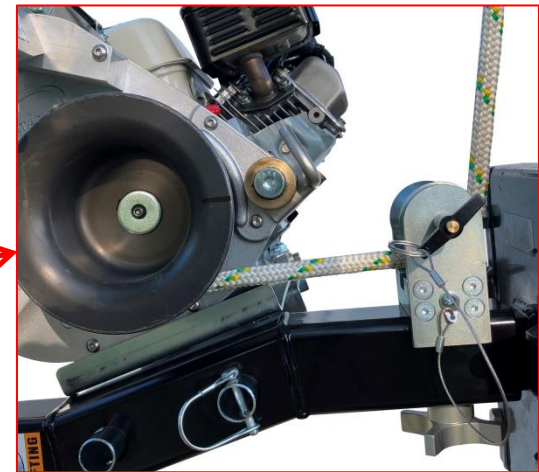
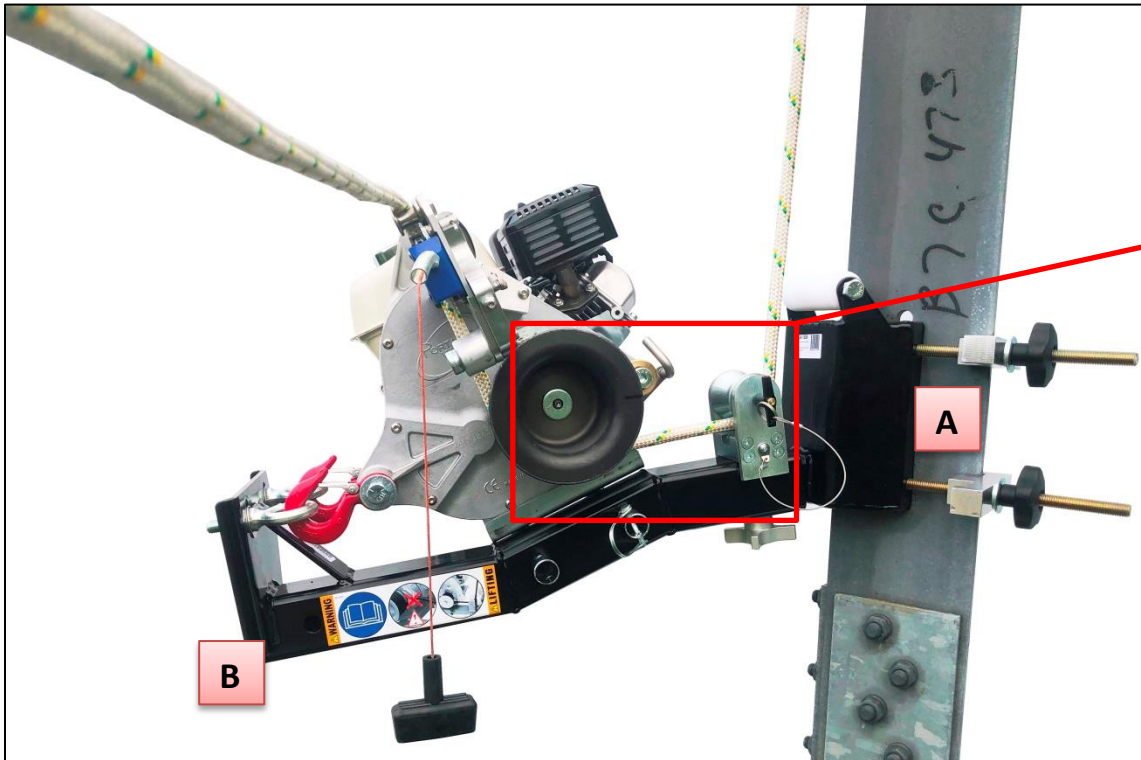

**⚠ ATTENTION** **DO NOT** GO OVER THE ROPE ENTRY PULLEY OF THE WINCH WITH THE ROPE AS IT WILL CREATE FRICTION AND WILL REDUCE LIFTING CAPACITY. **GO UNDER THE ROPE ENTRY PULLEY OF THE WINCH.** IN THIS CASE, THE ROPE ENTRY PULLEY OF THE WINCH WILL NOT BE USED.

# PCA-2264

## WINCH SUPPORT FOR VERTICAL PULLING

**User Manual**  
**READ CAREFULLY**

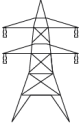

	Installation no. 4 - The winch faces the load. The rope is directly in line with the winch (horizontal).	
	Accessories used	
	A	PCA-1806 Pylon mount winch anchor
	B	PCA-1332 Pivoting anchor for vertical pull support
C	PCA-2264 Winch support for vertical pulling	

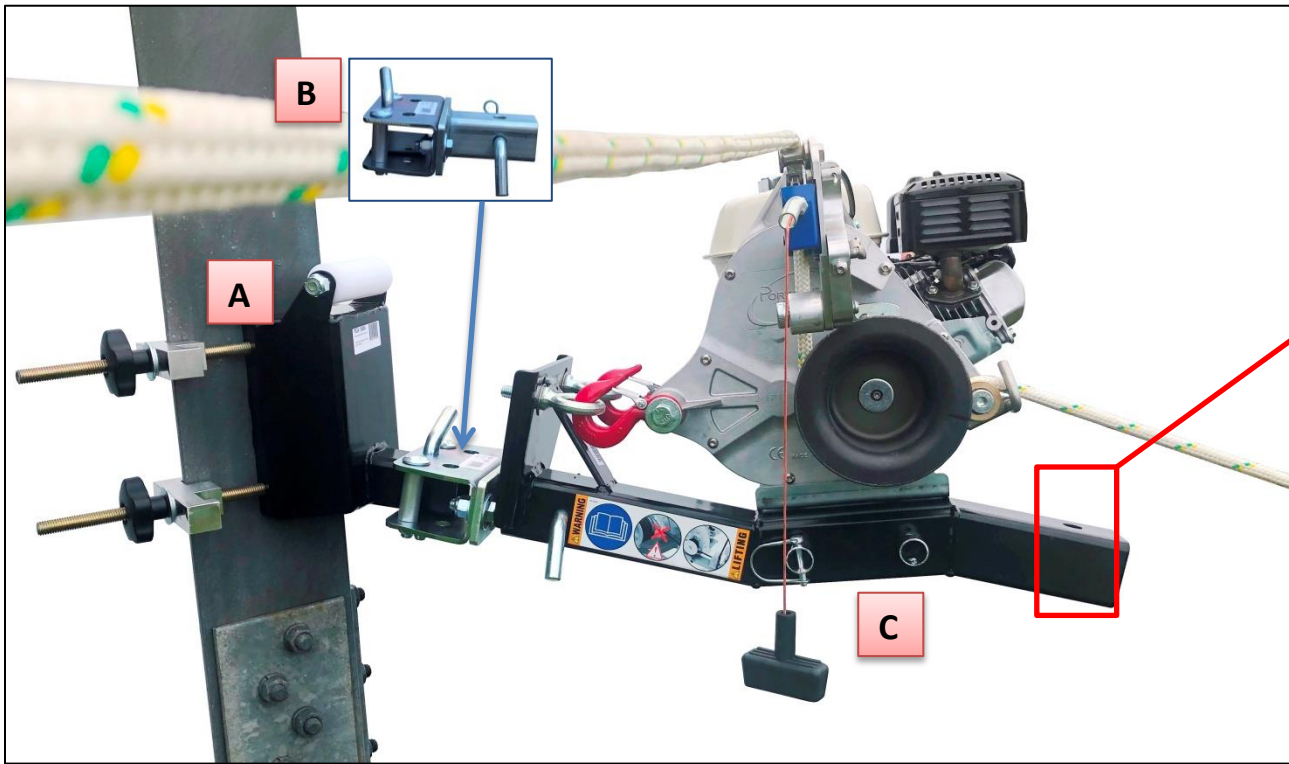
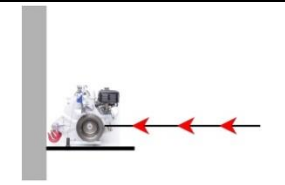

IN THIS SITUATION,  
**DO NOT USE THE REDIRECT PULLEY**  
Supplied with the Winch support for vertical pulling.

**ATTENTION** WHEN USED IN DIRECT LINE, THE PIVOTING ANCHOR FOR VERTICAL PULL SUPPORT (PCA-1332) MUST BE FIXED TO THE WINCH SUPPORT FOR VERTICAL PULL (PCA-2264). THIS ANCHOR (SOLD SEPARATELY) WILL ALLOW THE WINCH TO ALIGN WITH THE LOAD.

**ATTENTION** PUT THE ROPE ON THE WINCH ENTRY PULLEY.



# PCA-2264

## WINCH SUPPORT FOR VERTICAL PULLING

**User Manual**  
**READ CAREFULLY**



	Installation no. 5 - The winch faces the anchoring. The rope comes from the top towards the winch (vertical).		
	Accessories used		
	A	PCA-1267/1501	
B	PCA-2264	Winch support for vertical pulling	

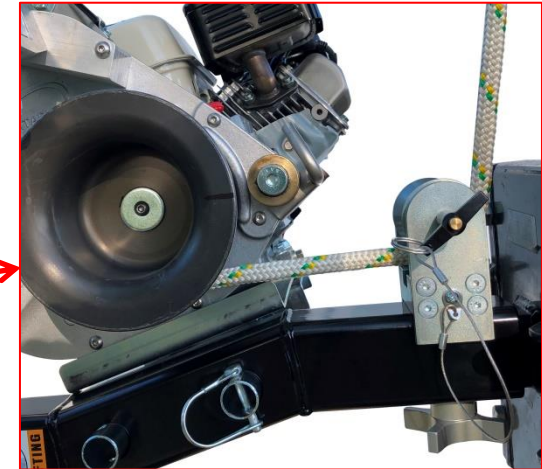
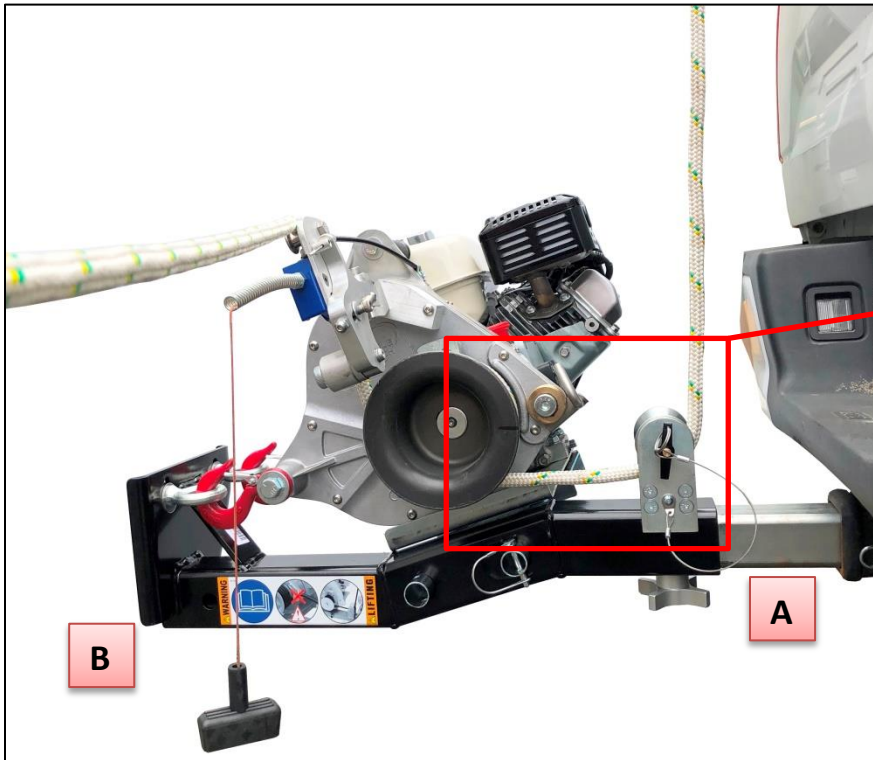

**⚠ ATTENTION** **DO NOT** GO OVER THE ROPE ENTRY PULLEY OF THE WINCH WITH THE ROPE AS IT WILL CREATE FRICTION AND WILL REDUCE LIFTING CAPACITY. **GO UNDER THE ROPE ENTRY PULLEY OF THE WINCH.** IN THIS CASE, THE ROPE ENTRY PULLEY OF THE WINCH WILL NOT BE USED.

# PCA-2264

## WINCH SUPPORT FOR VERTICAL PULLING

**User Manual**  
**READ CAREFULLY**



	Installation no. 6 - The winch faces the load. The rope is directly in line with the winch (horizontal).	
	Accessories used	
	A	PCA-1267/1501 Square tube for trailer hitch ( <b>vehicle</b> )
	B	PCA-1332 Pivoting anchor for vertical pull support
C	PCA-2264 Winch support for vertical pulling	

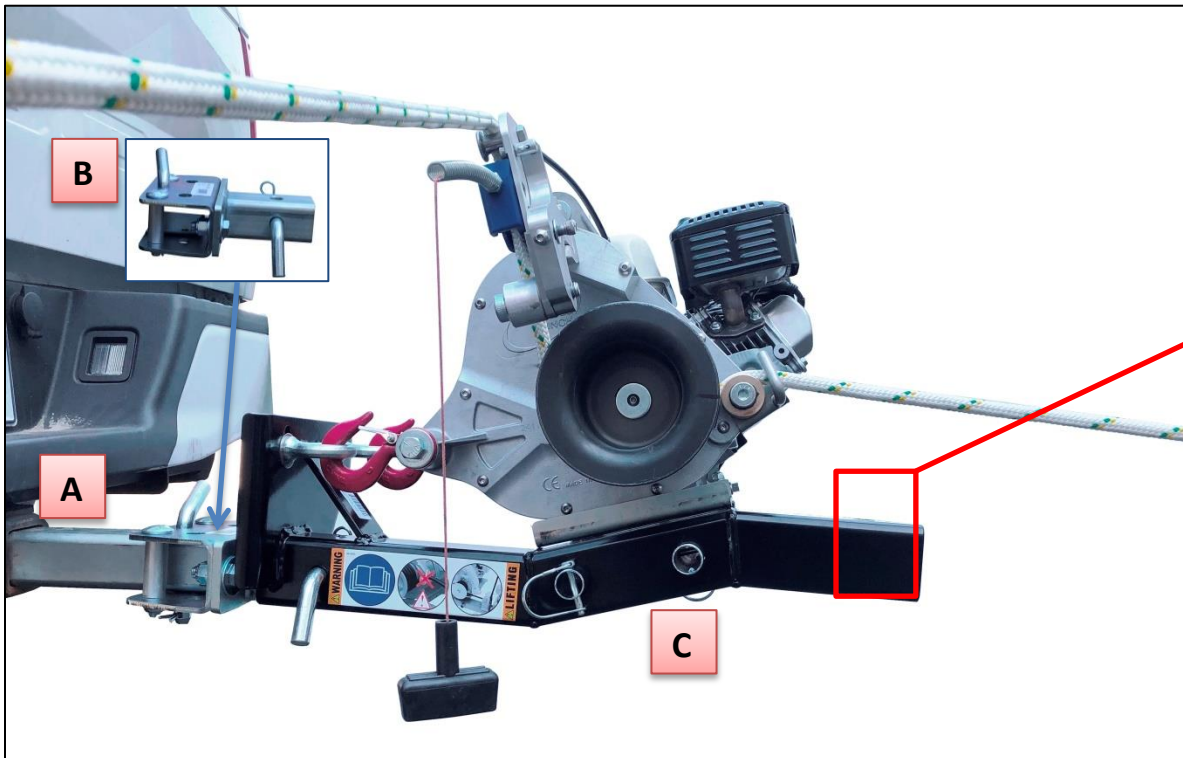
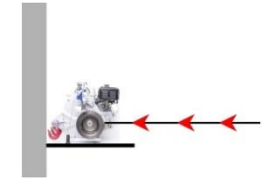

IN THIS SITUATION,  
**DO NOT USE THE REDIRECT PULLEY**  
Supplied with the  
Winch support for  
vertical pulling.

**⚠ ATTENTION** WHEN USED IN DIRECT LINE, THE PIVOTING ANCHOR FOR VERTICAL PULL SUPPORT (PCA-1332) MUST BE FIXED TO THE WINCH SUPPORT FOR VERTICAL PULL (PCA-2264). THIS ANCHOR (SOLD SEPARATELY) WILL ALLOW THE WINCH TO ALIGN WITH THE LOAD.

**⚠ ATTENTION** PUT THE ROPE ON THE WINCH ENTRY PULLEY.

# PCA-2264

## WINCH SUPPORT FOR VERTICAL PULLING

User Manual  
READ CAREFULLY



	Installation no. 7 - The winch faces the anchoring. The rope comes from the top towards the winch (vertical).		
	Accessories used		
	A	PCA-1266 Heck-Pack anchoring system with adaptor for 50 mm towing balls ( <b>vehicle</b> )	
B	PCA-2264 Winch support for vertical pulling		

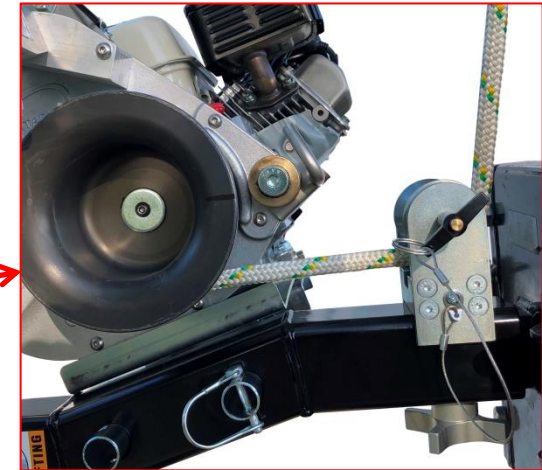
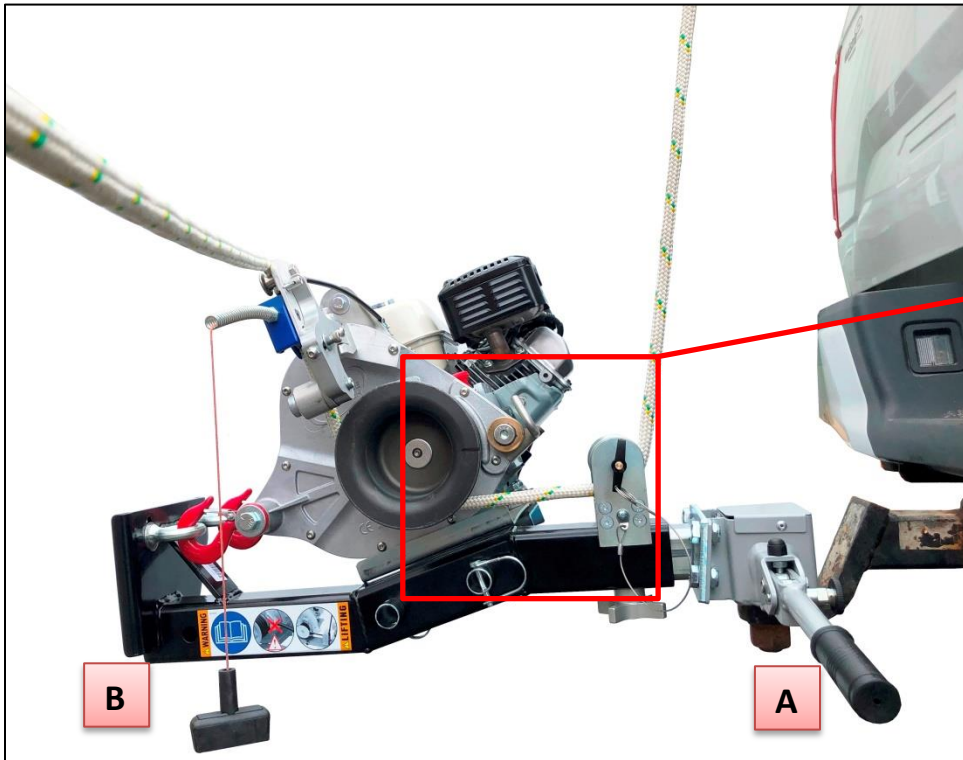

**⚠ ATTENTION** DO NOT GO OVER THE ROPE ENTRY PULLEY OF THE WINCH WITH THE ROPE AS IT WILL CREATE FRICTION AND WILL REDUCE LIFTING CAPACITY. GO UNDER THE ROPE ENTRY PULLEY OF THE WINCH. IN THIS CASE, THE ROPE ENTRY PULLEY OF THE WINCH WILL NOT BE USED.

# PCA-2264

## WINCH SUPPORT FOR VERTICAL PULLING

**User Manual**  
**READ CAREFULLY**



	Installation no. 8 - The winch faces the load. The rope is directly in line with the winch (horizontal).	
	Accessories used	
	A	PCA-1266 Heck-Pack anchoring system with adaptor for 50 mm towing balls ( <b>vehicle</b> )
	B	PCA-1332 Pivoting anchor for vertical pull support
C	PCA-2264 Winch support for vertical pulling	

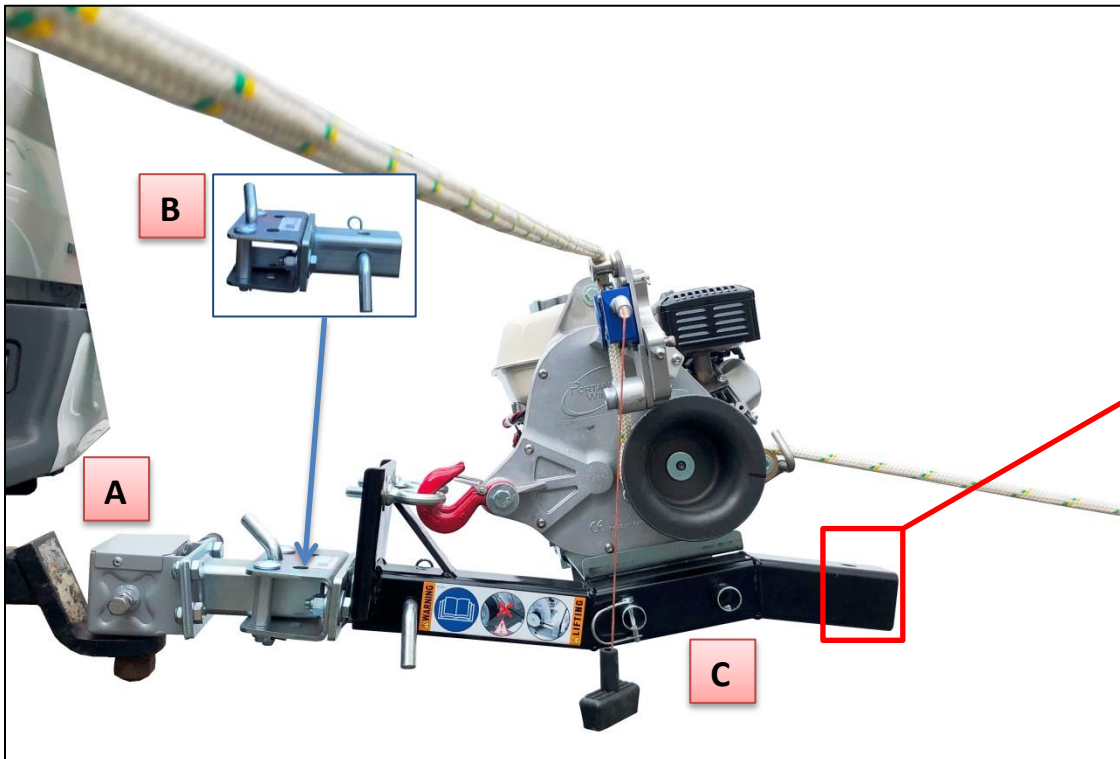
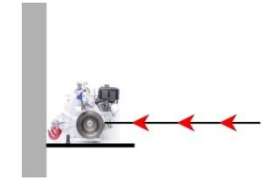

IN THIS SITUATION,  
**DO NOT USE THE REDIRECT PULLEY**  
Supplied with the  
*Winch support for vertical pulling.*

**⚠ ATTENTION** WHEN USED IN DIRECT LINE, THE PIVOTING ANCHOR FOR VERTICAL PULL SUPPORT (PCA-1332) MUST BE FIXED TO THE WINCH SUPPORT FOR VERTICAL PULL (PCA-2264). THIS ANCHOR (SOLD SEPARATELY) WILL ALLOW THE WINCH TO ALIGN WITH THE LOAD.

**⚠ ATTENTION** PUT THE ROPE ON THE WINCH ENTRY PULLEY.

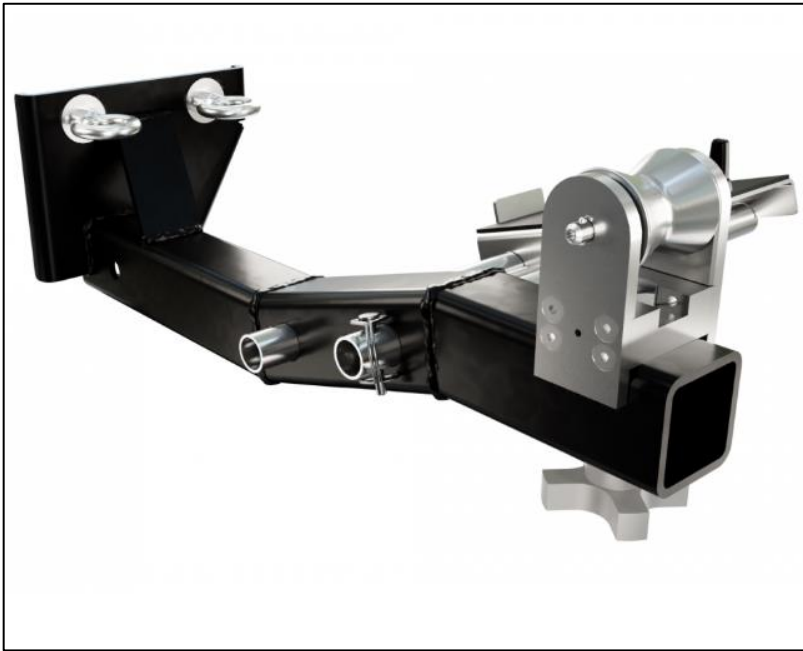

**PCA-2264**  
**SUPPORT DE TREUIL POUR TIRE VERTICALE**

**MANUEL D'UTILISATION**

# PCA-2264

## SUPPORT DE TREUIL POUR TIRE VERTICALE

**Manuel d'utilisation  
À LIRE ATTENTIVEMENT**

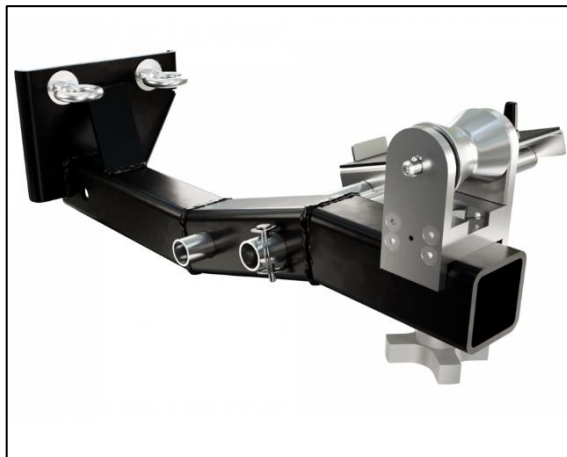

Portable Winch Co. vous remercie de votre confiance et vous félicite pour l'achat du **Support de treuil pour tire verticale PCA-2264**.

Le **Support pour tire verticale** est composé de trois éléments principaux :

- A : Cadre
- B : Tablette ajustable
- C : Poulie de redirection

Si un des éléments est manquant, veuillez contacter votre revendeur autorisé.

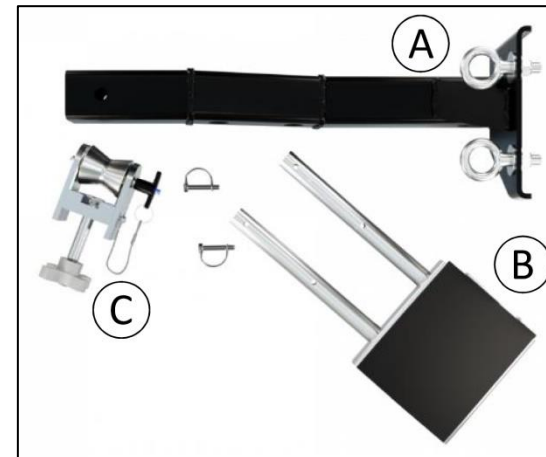

Le **Support de treuil pour tire verticale** peut être ancré à différents accessoires en fonction du point d'ancrage disponible et du travail à accomplir. Tous sont vendus séparément.

Consultez la **charte d'ancrages** de la page suivante pour repérer votre situation et connaître les instructions d'installation et d'utilisation.

**ATTENTION** Afin d'utiliser ce produit de façon sécuritaire, il est important que **tous les utilisateurs lisent attentivement ce manuel**.

**ATTENTION** Ne jamais dépasser la force de tire nominale du treuil utilisé en ligne simple. Référez-vous au manuel de l'utilisateur du modèle de treuil utilisé.

**ATTENTION** Performez un test de tire avec une charge légère afin de vous assurer de la stabilité de l'installation de l'équipement.

**ATTENTION** Après avoir mis le dispositif en charge, relâchez la tension du treuil et vérifiez la solidité de l'ancrage.





# PCA-2264

## SUPPORT DE TREUIL POUR TIRE VERTICALE

**Manuel d'utilisation  
À LIRE ATTENTIVEMENT**

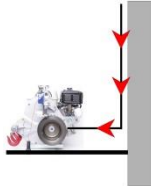
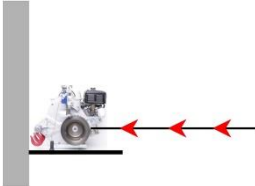
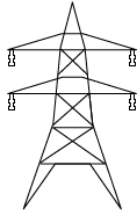

### CHARTE D'ANCRAGES

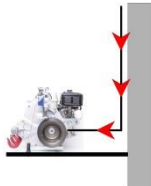
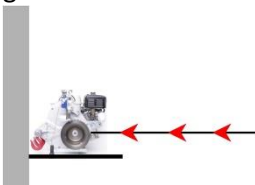



TYPE DE POINT D'ANCRAGE	ACCESSOIRE D'ANCRAGE À UTILISER POUR FIXER LE SUPPORT PCA-2264	POSITION DU TREUIL ET DIRECTION SOUHAITÉE DE LA CORDE	RÉFÉRENCE
Forme cylindrique (arbre, poteau, etc.) 	<b>PCA-1263</b> Système d'ancrage de treuil pour arbres et poteaux. 	Le treuil fait face à l'ancrage. La corde vient du haut vers le treuil (verticale). 	Installation no. 1 (page 5)
		Le treuil fait face à la charge. La corde est en ligne directe vers le treuil (horizontale). 	Installation no. 2 (page 6)
Pylône (avec pattes en forme de 'V' à 90°) 	<b>PCA-1806</b> Système d'ancrage de treuil pour pylônes. 	Le treuil fait face à l'ancrage. La corde vient du haut vers le treuil (verticale). 	Installation no. 3 (page 7)
		Le treuil fait face à la charge. La corde est en ligne directe vers le treuil (horizontale). 	Installation no. 4 (page 8)

# PCA-2264

## SUPPORT DE TREUIL POUR TIRE VERTICALE

**Manuel d'utilisation  
À LIRE ATTENTIVEMENT**

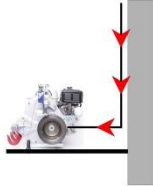
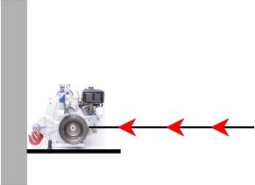

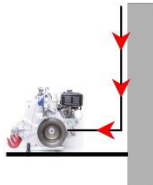
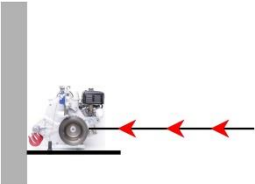
TYPE DE POINT D'ANCRAGE	ACCESSOIRE D'ANCRAGE UTILISÉ SUR LEQUEL SERA FIXÉ LE SUPPORT PCA-2264	DIRECTION SOUHAITÉE DE LA CORDE ET POSITION DU TREUIL	RÉFÉRENCE
	<p><b>PCA-1267 ou PCA-1501</b> Tube carré pour attelage de véhicules.</p> 	<p>Le treuil fait face à l'ancrage. La corde vient du haut vers le treuil (verticale).</p> 	Installation no. 5 (page 9)
		<p>Le treuil fait face à la charge. La corde est en ligne directe vers le treuil (horizontale).</p> 	Installation no. 6 (page 10)
	<p><b>PCA-1266</b> Système d'ancrage Heck-Pack avec adaptateur pour boule de véhicules (50 mm).</p> 	<p>Le treuil fait face à l'ancrage. La corde vient du haut vers le treuil (verticale).</p> 	Installation no. 7 (page 11)
		<p>Le treuil fait face à la charge. La corde est en ligne directe vers le treuil (horizontale).</p> 	Installation no. 8 (page 12)



# PCA-2264

## SUPPORT DE TREUIL POUR TIRE VERTICALE

**Manuel d'utilisation  
À LIRE ATTENTIVEMENT**

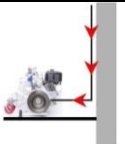

	Installation no. 1 - Le treuil fait face à l'ancrage. La corde vient du haut vers le treuil (verticale).			
	Accessoires utilisés			
	A	PCA-1263		Système d'ancrage de treuil pour <b>arbres et poteaux</b>
	B	PCA-2264		Support pour tire verticale

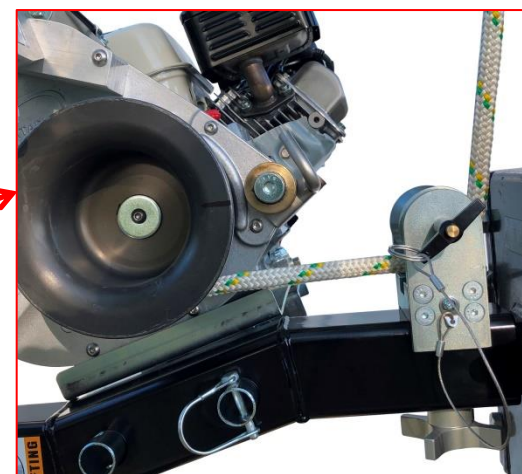
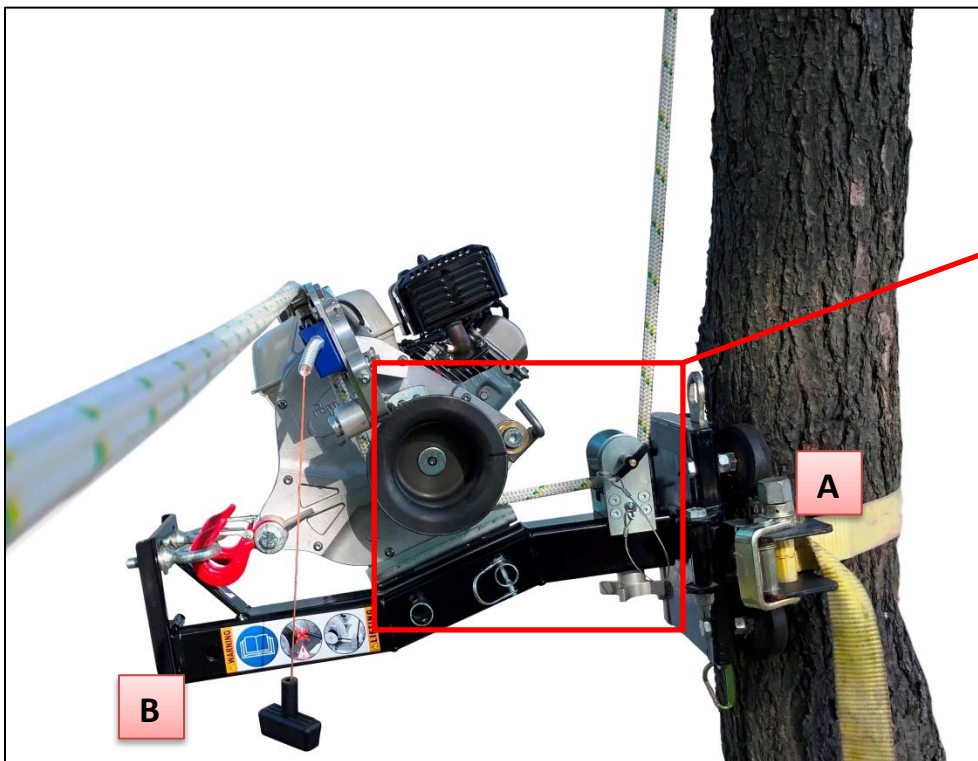

**⚠ ATTENTION** **NE PASSEZ PAS LA CORDE SUR LA POULIE GUIDE D'ENTRÉE DU TREUIL CAR CELA CRÉERA DE LA FRICTION ET RÉDUIRA LA CAPACITÉ DE TIRAGE. PASSEZ PLUTÔT LA CORDE SOUS LA POULIE GUIDE D'ENTRÉE DU TREUIL. DANS CE CAS, LA POULIE GUIDE D'ENTRÉE DU TREUIL NE SERA PAS UTILISÉE.**

# PCA-2264

## SUPPORT DE TREUIL POUR TIRE VERTICALE

**Manuel d'utilisation  
À LIRE ATTENTIVEMENT**



	Installation no. 2 - Le treuil fait face à la charge. La corde est en ligne directe vers le treuil (horizontale).	
	Accessoires utilisés	
	A	PCA-1263 Système d'ancrage de treuil pour <b>arbres et poteaux</b>
	B	PCA-1332 Ancrage pivotant pour support de tire verticale
C	PCA-2264 Support pour tire verticale	

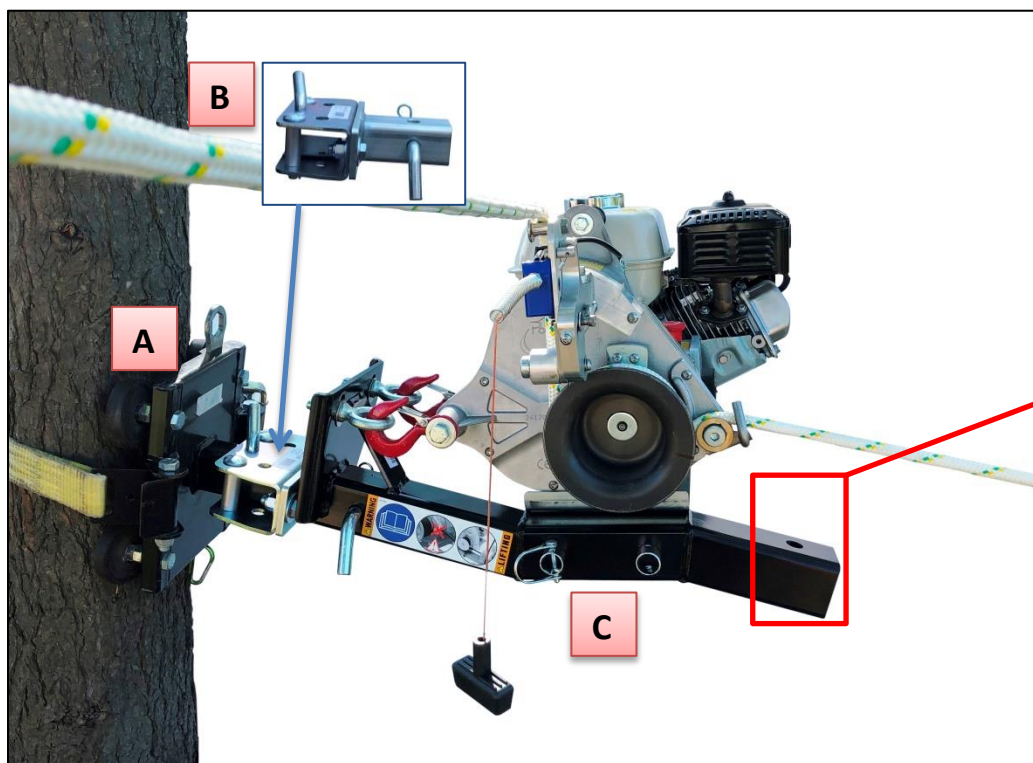
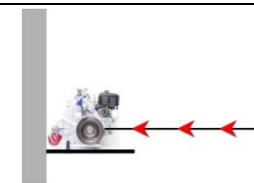

DANS CETTE SITUATION,  
**N'UTILISEZ PAS LA**  
**POULIE DE**  
**REDIRECTION**  
fournie avec le *Support*  
pour tire verticale.

**⚠ ATTENTION** LORSQU'UTILISÉ EN LIGNE DIRECTE, L'ANCRAGE PIVOTANT POUR SUPPORT DE TIRE (PCA-1332) DOIT ÊTRE ARRIMÉ AU SUPPORT POUR TIRE VERTICALE (PCA-2264). CET ANCRAGE (VENDU SÉPARÉMENT) PERMETTRA AU TREUIL DE S'ALIGNER AVEC LA CHARGE.

**⚠ ATTENTION** PASSEZ LA CORDE SUR LA POULIE GUIDE D'ENTRÉE DU TREUIL.

# PCA-2264

## SUPPORT DE TREUIL POUR TIRE VERTICALE

**Manuel d'utilisation  
À LIRE ATTENTIVEMENT**

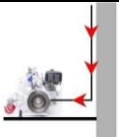

	Installation no. 3 - Le treuil fait face à l'ancrage. La corde vient du haut vers le treuil (verticale).		
	Accessoires utilisés		
	A	PCA-1806	
B	PCA-2264	Support pour tire verticale	

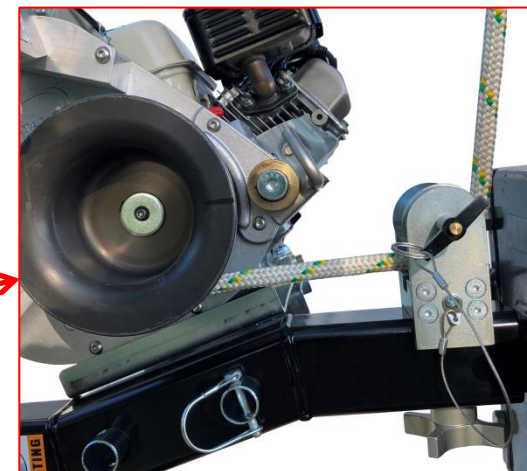
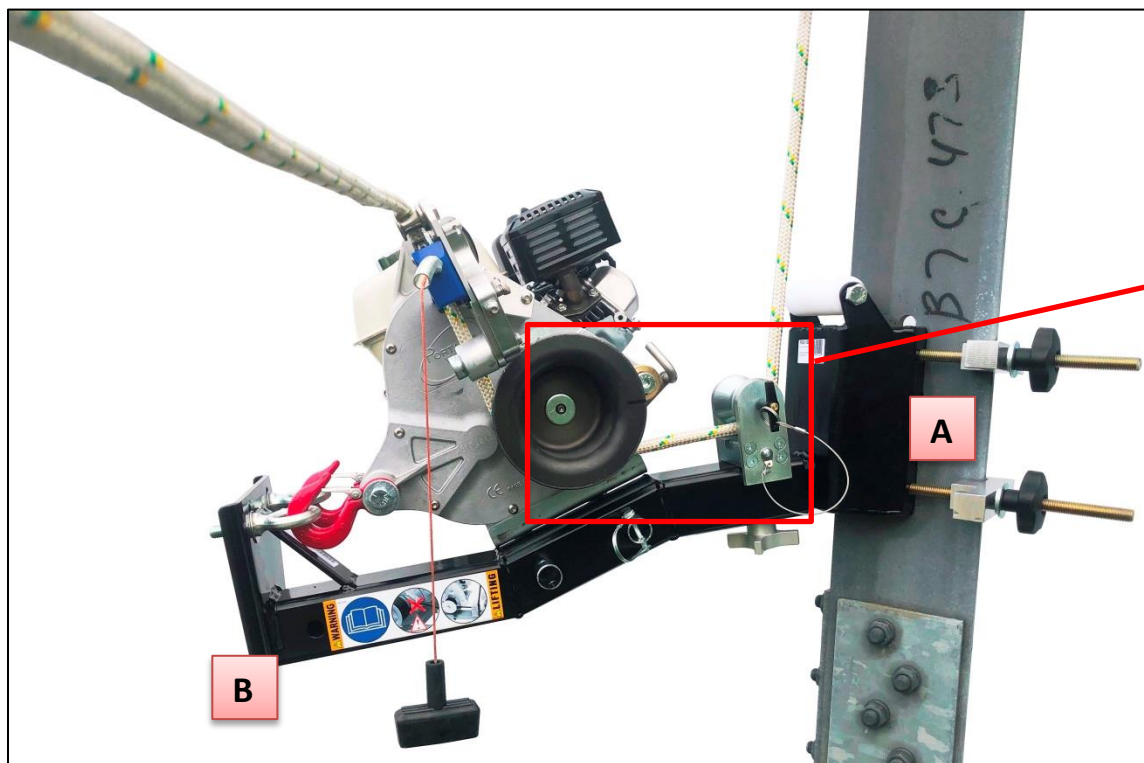

**⚠ ATTENTION** **NE PASSEZ PAS LA CORDE SUR LA POULIE GUIDE D'ENTRÉE DU TREUIL CAR CELA CRÉERA DE LA FRICTION ET RÉDUIRA LA CAPACITÉ DE TIRAGE. PASSEZ PLUTÔT LA CORDE SOUS LA POULIE GUIDE D'ENTRÉE DU TREUIL. DANS CE CAS, LA POULIE GUIDE D'ENTRÉE DU TREUIL NE SERA PAS UTILISÉE.**

# PCA-2264

## SUPPORT DE TREUIL POUR TIRE VERTICALE

**Manuel d'utilisation  
À LIRE ATTENTIVEMENT**



	Installation no. 4 - Le treuil fait face à la charge. La corde est en ligne directe vers le treuil (horizontale).	
	Accessoires utilisés	
	A	PCA-1806 Système d'ancrage de treuil pour pylônes
	B	PCA-1332 Ancrage pivotant pour support de tire verticale
C	PCA-2264 Support pour tire verticale	

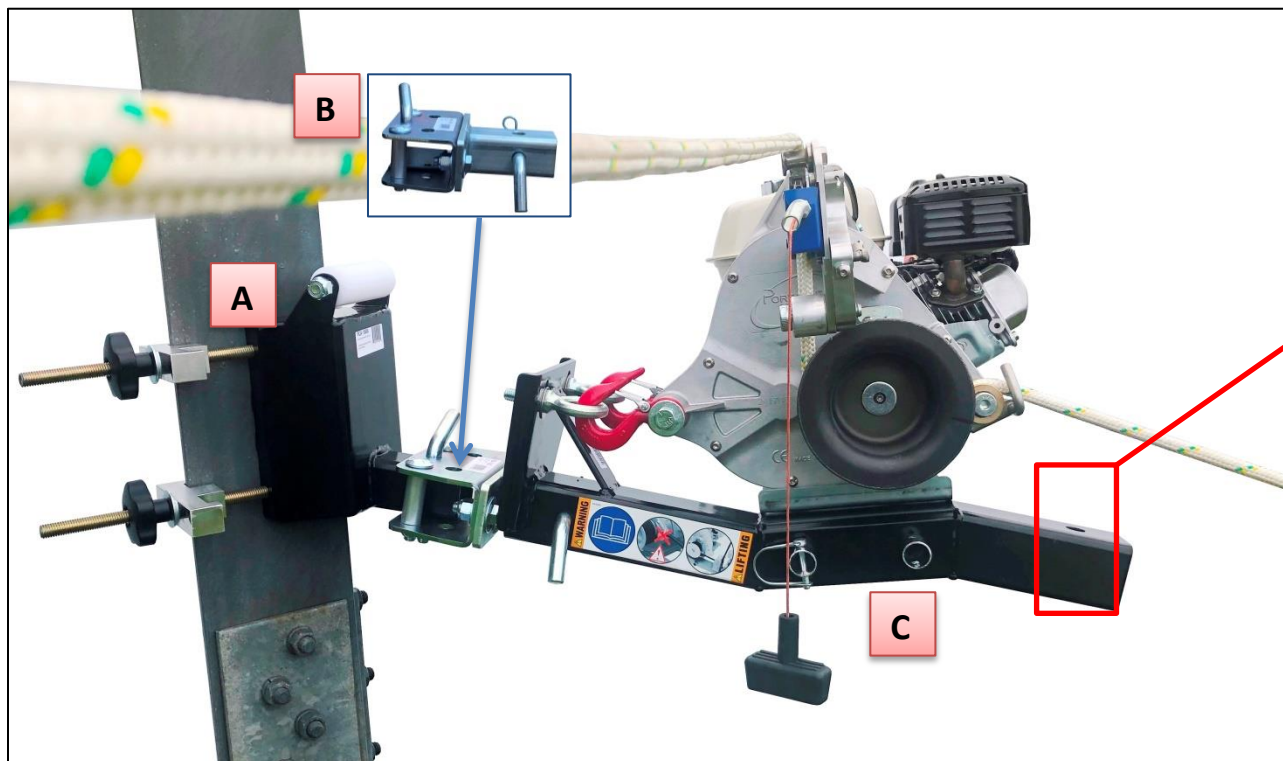
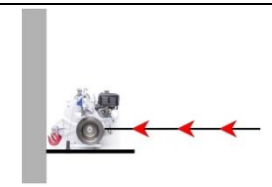

DANS CETTE SITUATION,  
**N'UTILISEZ PAS LA  
POULIE DE  
REDIRECTION**  
fournie avec le Support  
pour tire verticale.

**ATTENTION** LORSQU'UTILISÉ EN LIGNE DIRECTE, L'ANCRAGE PIVOTANT POUR SUPPORT DE TIRE (PCA-1332) DOIT ÊTRE ARRIMÉ AU SUPPORT POUR TIRE VERTICALE (PCA-2264). CET ANCRAGE (VENDU SÉPARÉMENT) PERMETTRA AU TREUIL DE S'ALIGNER AVEC LA CHARGE.

**ATTENTION** PASSEZ LA CORDE SUR LA POULIE GUIDE D'ENTRÉE DU TREUIL.

# PCA-2264

## SUPPORT DE TREUIL POUR TIRE VERTICALE

**Manuel d'utilisation  
À LIRE ATTENTIVEMENT**



	Installation no. 5 - Le treuil fait face à l'ancrage. La corde vient du haut vers le treuil (verticale).		
	Accessoires utilisés		
	A	PCA-1267/1501	
B	PCA-2264	Support pour tire verticale	

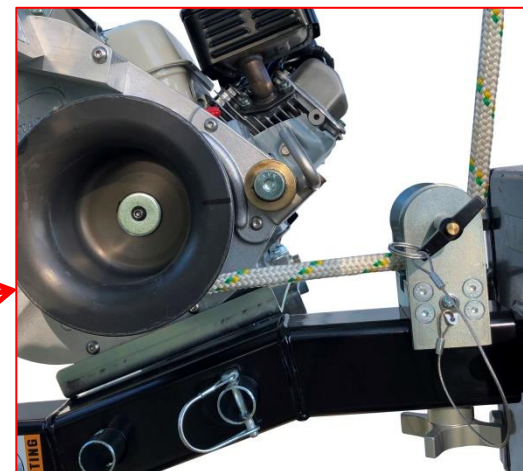
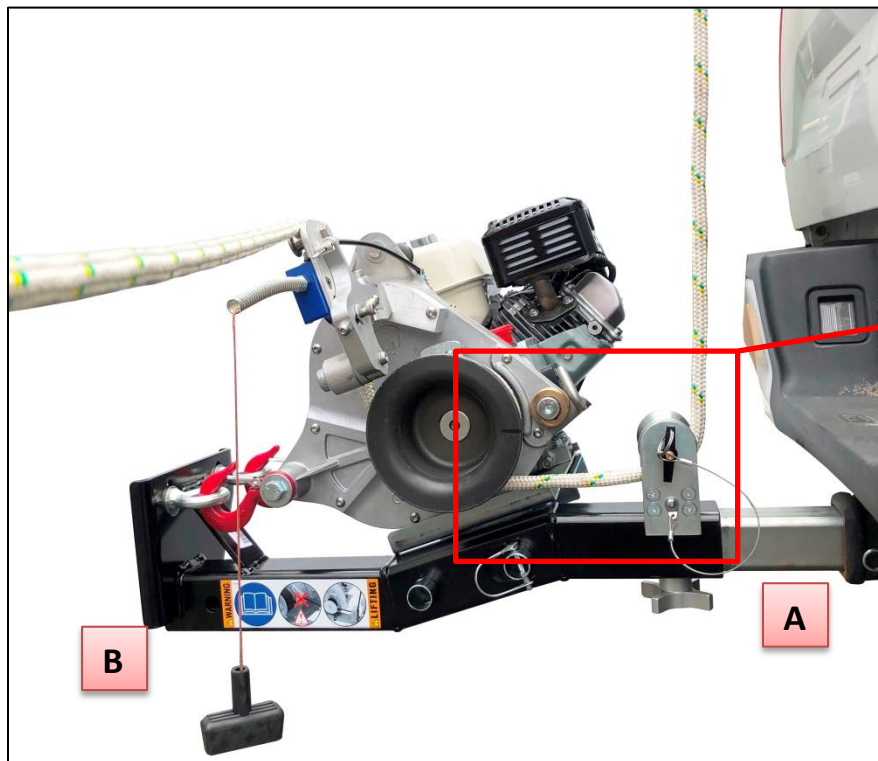

**⚠ ATTENTION** **NE PASSEZ PAS LA CORDE SUR LA POULIE GUIDE D'ENTRÉE DU TREUIL CAR CELA CRÉERA DE LA FRICTION ET RÉDUIRA LA CAPACITÉ DE TIRAGE. PASSEZ PLUTÔT LA CORDE SOUS LA POULIE GUIDE D'ENTRÉE DU TREUIL. DANS CE CAS, LA POULIE GUIDE D'ENTRÉE DU TREUIL NE SERA PAS UTILISÉE.**

# PCA-2264

## SUPPORT DE TREUIL POUR TIRE VERTICALE

**Manuel d'utilisation  
À LIRE ATTENTIVEMENT**

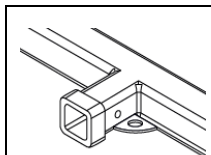

Installation no. 6 - Le treuil fait face à la charge. La corde est en ligne directe vers le treuil (horizontale).

Accessoires utilisés

A	PCA-1267/1501	Tube carré pour attelage de <b>véhicules</b>
B	PCA-1332	Ancrage pivotant pour support de tire verticale
C	PCA-2264	Support pour tire verticale

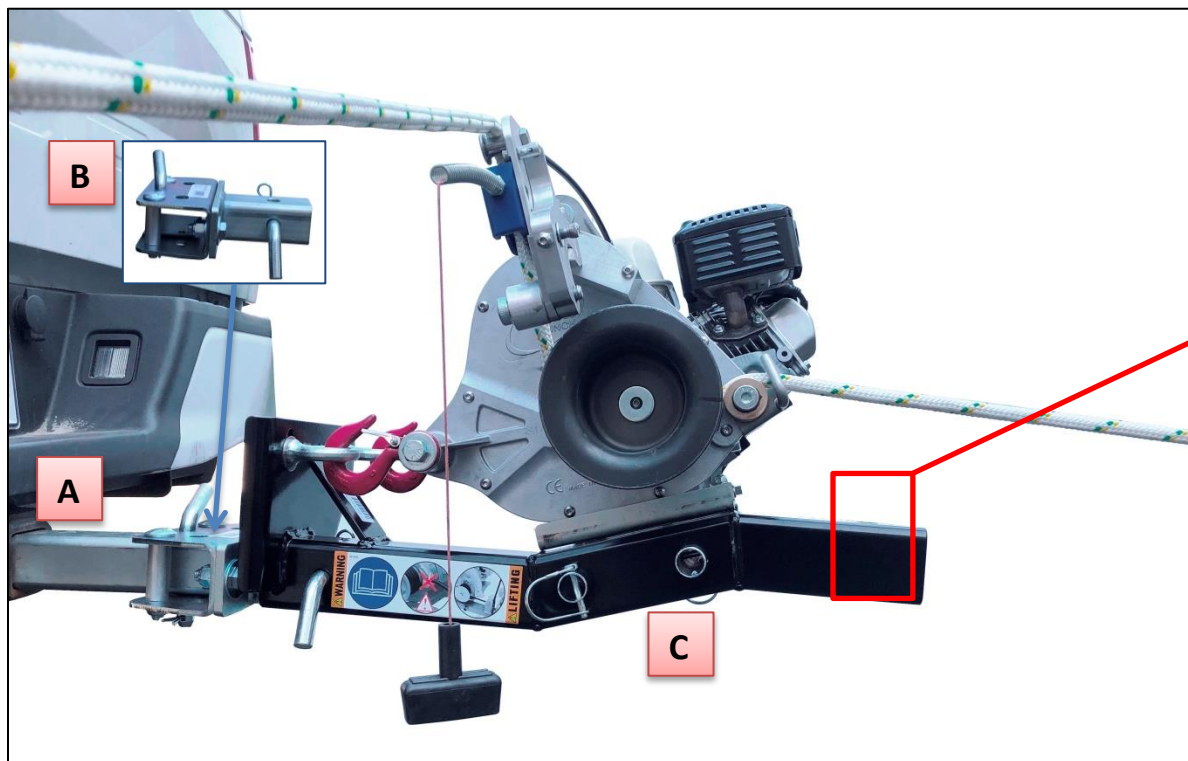
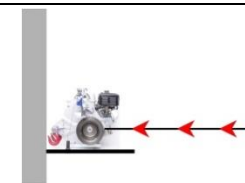

DANS CETTE SITUATION,  
**N'UTILISEZ PAS LA  
POULIE DE  
REDIRECTION**  
fournie avec le Support  
pour tire verticale.

**ATTENTION** LORSQU'UTILISÉ EN LIGNE DIRECTE, L'ANCRAGE PIVOTANT POUR SUPPORT DE TIRE (PCA-1332) DOIT ÊTRE ARRIMÉ AU SUPPORT POUR TIRE VERTICALE (PCA-2264). CET ANCRAGE (VENDU SÉPARÉMENT) PERMETTRA AU TREUIL DE S'ALIGNER AVEC LA CHARGE.

**ATTENTION** PASSEZ LA CORDE SUR LA POULIE GUIDE D'ENTRÉE DU TREUIL.

# PCA-2264

## SUPPORT DE TREUIL POUR TIRE VERTICALE

**Manuel d'utilisation  
À LIRE ATTENTIVEMENT**



	Installation no. 7 - Le treuil fait face à l'ancrage. La corde vient du haut vers le treuil (verticale).		
	Accessoires utilisés		
	A	PCA-1266	
B	PCA-2264	Support pour tire verticale	

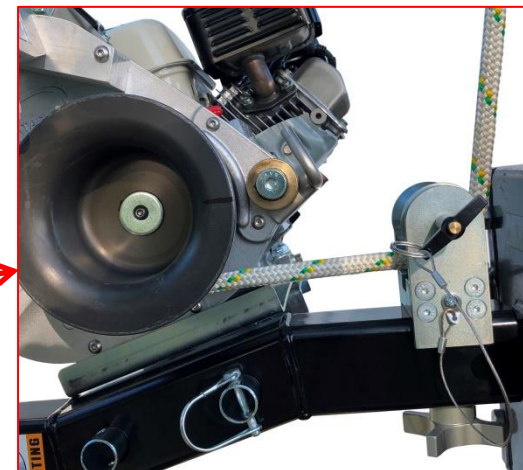
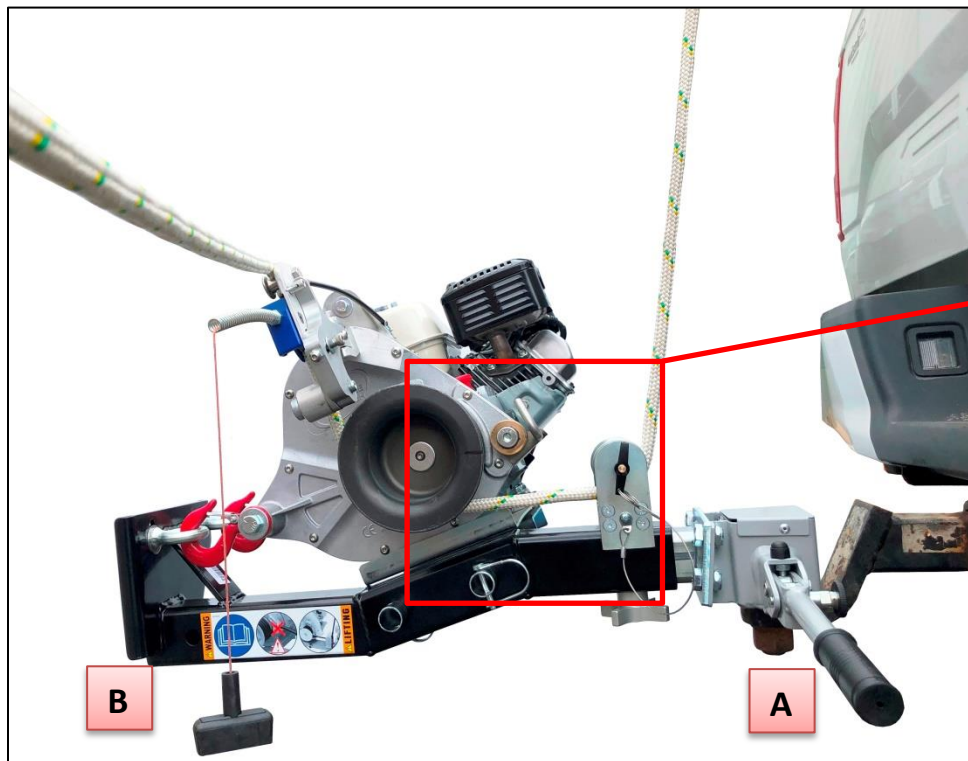

**ATTENTION** **NE PASSEZ PAS LA CORDE SUR LA POULIE GUIDE D'ENTRÉE DU TREUIL CAR CELA CRÉERA DE LA FRICTION ET RÉDUIRA LA CAPACITÉ DE TIRAGE. PASSEZ PLUTÔT LA CORDE SOUS LA POULIE GUIDE D'ENTRÉE DU TREUIL. DANS CE CAS, LA POULIE GUIDE D'ENTRÉE DU TREUIL NE SERA PAS UTILISÉE.**

# PCA-2264

## SUPPORT DE TREUIL POUR TIRE VERTICALE

**Manuel d'utilisation  
À LIRE ATTENTIVEMENT**



	Installation no. 8 - Le treuil fait face à la charge. La corde est en ligne directe vers le treuil (horizontale).	
	Accessoires utilisés	
	A	PCA-1266 Système d'ancrage pour boule de <b>véhicules</b> (50 mm)
	B	PCA-1332 Ancrage pivotant pour support de tire verticale
C	PCA-2264 Support pour tire verticale	

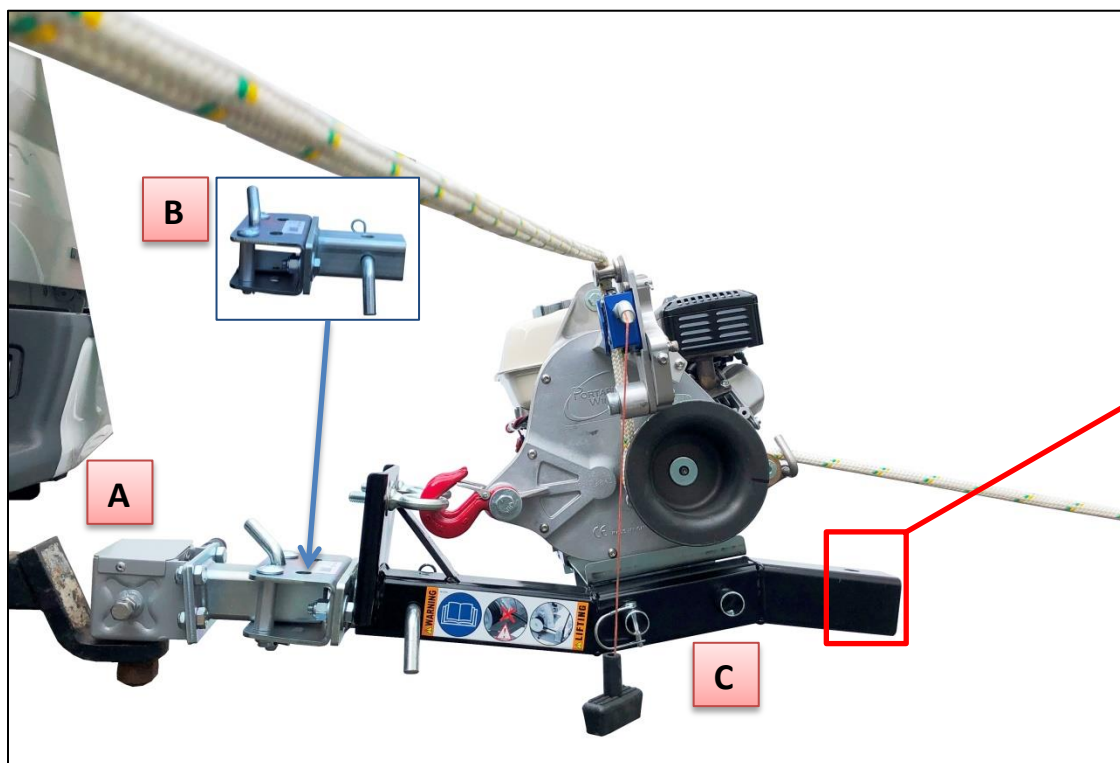
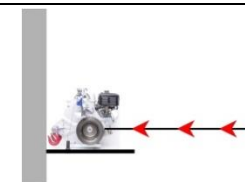

DANS CETTE SITUATION,  
**N'UTILISEZ PAS LA  
POULIE DE  
REDIRECTION**  
fournie avec le Support  
pour tire verticale.

**ATTENTION** LORSQU'UTILISÉ EN LIGNE DIRECTE, L'ANCRAGE PIVOTANT POUR SUPPORT DE TIRE (PCA-1332) DOIT ÊTRE ARRIMÉ AU SUPPORT POUR TIRE VERTICALE (PCA-2264). CET ANCRAGE (VENDU SÉPARÉMENT) PERMETTRA AU TREUIL DE S'ALIGNER AVEC LA CHARGE.

**ATTENTION** PASSEZ LA CORDE SUR LA POULIE GUIDE D'ENTRÉE DU TREUIL.