

ROIDMI Cordless Vacuum Cleaner Operation Manual

Read manual before use. Keep it well for future reference.

Pictures are for reference only, actual product may vary.



Scan the QR code for manuals
in multiple languages



CONTENTS

1. Latest operating instructions	2
2. Explanation of symbols	2
3. Safety instructions.....	2
4. Product overview.....	4
5. Parts and accessories.....	4
6. Assembly.....	5
7. Operation	5
8. Cleaning and maintenance.....	7
9. Troubleshooting.....	7
10. Technical data	8
11. Disposal.....	8
12. Warranty and limitations of liability	9

1. Latest operating instructions

Download the latest operating instructions via the link <https://www.roidmi.com/en/cms/so/admin> or scan the QR code shown. Follow the instructions on the website.



2. Explanation of symbols



The lightning symbol inside a triangle is used when there is a potential risk of personal injury, such as electric shock.



An exclamation mark in a triangle indicates important instructions in this operating manual that absolutely have to be observed.



The arrow symbol indicates specific tips and advice on operation.

3. Safety instructions

Read the manual before use.

IMPORTANT SAFETY INSTRUCTIONS

BEFORE USING READ ALL INSTRUCTIONS

When using an electrical appliance, basic precautions should always be followed, including the following: READ ALL INSTRUCTIONS BEFORE USING (THIS APPLIANCE). Failure to follow the warnings and instructions may result in electric shock, fire and/or serious injury.

WARNING – To reduce the risk of fire, electric shock, or injury:

WARNING:

1. If the supply cord is damaged, it must be replaced by the manufacturer, its service agent or qualified persons in order to avoid a hazard.
2. Before charging, read the instructions.
3. For indoor use only, do not expose to rain.
4. The battery charger is designed for charging the rechargeable battery provided by manufacturer.
5. Do not use any other charger to recharge the battery provided by manufacturer and do not try recharge other types of battery with this charger. Also do not try to charge non-rechargeable batteries with this charger.
6. Before charging, check whether the voltage specified on the marking label corresponds to the mains voltage.
7. During charging, the appliance must be placed at well-ventilated area.
8. Please remove the plug from the socket before cleaning or maintaining the charger.
9. The appliance is only to be used with the power supply unit provided with the appliance.
10. This appliance contains batteries that are only replaceable by skilled persons.
11. The battery must be removed from the appliance before it is scrapped.
12. The appliance must be disconnected from the supply mains when removing the battery.
13. This appliance can be used by children aged from 8 years and above and persons with reduced physical, sensory or mental capabilities or lack of experience and knowledge only if they have been given supervision or instruction concerning use of the appliance in a safe way and understand the hazards involved.
14. Cleaning and user maintenance shall not be made by children without supervision.
15. Children should not play with the appliance.
16. Do not use outdoors or on wet surfaces.
17. Do not allow to be used as a toy. Close attention is necessary when used by or near children, pets or plants.
18. Use only as described in this manual. Use only manufacturer's recommended attachments.
19. Do not use with damaged cord or plug. If appliance is not working as it should, has been dropped, damaged, left outdoors, or dropped into water, return it to a service center.
20. Do not pull or carry by cord, use cord as a handle, close a door on cord, or pull cord around sharp edges or corners. Do not run appliance over cord. Keep cord away from heated surfaces.
21. Do not unplug by pulling on cord. To unplug, grasp the plug, not the cord.
22. Do not handle charger, including charger plug, and charger terminals with wet hands.
23. Do not put any object into openings. Do not use with any opening blocked; keep free of dust, lint, hair, and anything that may reduce air flow.
24. Keep hair, loose clothing, fingers, and all parts of body away from openings and moving parts.
25. Use extra care when cleaning on stairs.
26. Do not use to pick up flammable or combustible liquids, such as gasoline, or use in areas where they may be present.
27. Do not pick up anything that is burning or smoking, such as cigarettes, matches, or hot ashes.
28. Do not use without dust cup and filter in place.
29. Prevent unintentional starting. Ensure the switch is in the off-position before connecting to battery pack, picking up or carrying the appliance. Carrying the appliance with your finger on the switch or energizing appliance that have the switch on invites accidents.
30. Disconnect the battery pack from the appliance before making any adjustments, changing accessories, or storing appliance. Such preventive safety measures reduce the risk of starting the appliance accidentally.

31. Recharge only with the charger specified by the manufacturer. A charger that is suitable for one type of battery pack may create a risk of fire when used with another battery pack.
32. Use appliances only with specifically designated battery packs. Use of any other battery packs may create a risk of injury and fire.
33. When battery pack is not in use, keep it away from other metal objects, like paper clips, coins, keys, nails, screws or other small metal objects, which can make a connection from one terminal to another. Shorting the battery terminals together may cause burns or a fire.
34. Under abusive conditions, liquid may be ejected from the battery; avoid contact. If contact accidentally occurs, flush with water. If liquid contacts eyes, additionally seek medical help. Liquid ejected from the battery may cause irritation or burns.
35. Do not use a battery pack or appliance that is damaged or modified. Damaged or modified batteries may exhibit unpredictable behavior resulting in fire, explosion or risk of injury.
36. Do not expose a battery pack or appliance to fire or excessive temperature. Exposure to fire or temperature above 266°F (130°C) may cause explosion.
37. Follow all charging instructions and do not charge the battery pack or appliance outside of the temperature range specified in the instructions. Charging improperly or at temperatures outside of the specified range may damage the battery and increase the risk of fire.
38. Have servicing performed by a qualified repair person using only identical replacement parts. This will ensure that the safety of the product is maintained.
39. Do not modify or attempt to repair the appliance or the battery pack except as indicated in the instructions for use and care.
40. Always turn off this appliance before connecting or disconnecting electric brush.

SAVE THESE INSTRUCTIONS

Household use only.

CAUTION:

1. Make sure the plug is well inserted to avoid electric shock, short circuit and fire.
2. Immediately cut off the power supply and unplug in case of product distortion, overheat, unusual smell and sound during charging or operation. Place the product in an open and non-combustible area. Have servicing performed by the manufacturer or a qualified repair person. This will ensure that the safety is maintained.
3. Do not pour water on the product or plug or immerse them in water.
4. If the brush roller fails, turn off the vacuum cleaner immediately. Check if the brush roller is wrapped by hair or other excessively long fibers and clean.
5. Keep the vacuum cleaner away from someone carrying a pacemaker device during use.
6. Keep the vacuum cleaner out of the reach of children or pets to avoid injuries when it is attached on the magnetic wall mount for storage.
7. When charging with the magnetic wall mount, make sure the main unit fits perfectly against the wall mount to avoid falling off and causing injuries.
8. When charging the main unit, make sure the battery indicator is on.
9. Keep children away from the magnetic wall mount, especially one with charging function. Product falling during charging can cause hazards such as electric shock due to leakage.
10. Do not drop the product. Do not place the product under any mechanical stress. Prevent the product from colliding with other objects.
11. Timely clean the dust cup to guarantee good air ventilation, so as to avoid poor suction or motor heating caused by air blockage.
12. Protect the vacuum cleaner from extreme temperatures. Recommended operating and storage temperatures are 32°F (0°C) to 95°F (35°C). Keep it in a cool and dry place.
13. Do not use vacuum cleaner to suck up water to avoid water entering the main unit and causing malfunction. When water enters the dust cup, turn off the vacuum cleaner immediately and empty the dust cup. Make sure the dust cup is completely dry.
14. Dry after washing the brush roller completely before reinstalling.
15. Timely clean attachments after use to prevent food residue, cotton wool from rotting in them.
16. Use only the cleaning brush supplied by the manufacturer to clean the dust cup filter. Do not use other steel or hard brushes.
17. Keep the cleaning brush out of the reach of children to avoid injury. With a sharp blade, the cleaning brush is used to cut off entangled substances that are difficult to clean.

FCC STATEMENT

1. This device complies with Part 15 of the FCC Rules. Operation is subject to the following two conditions:
 - (1) This device may not cause harmful interference.
 - (2) This device must accept any interference received, including interference that may cause undesired operation.
2. Changes or modifications not expressly approved by the party responsible for compliance could void the user's authority to operate the equipment.

NOTE: This equipment has been tested and found to comply with the limits for a Class B digital device, pursuant to Part 15 of the FCC Rules. These limits are designed to provide reasonable protection against harmful interference in a residential installation.

This equipment generates uses and can radiate radio frequency energy and, if not installed and used in accordance with the instructions, may cause harmful interference to radio communications. However, there is no guarantee that interference will not occur in a particular installation.

If this equipment does cause harmful interference to radio or television reception, which can be determined by turning the equipment off and on.

The user is encouraged to try to correct the interference by one or more of the following measures:

- (1) Reorient or relocate the receiving antenna.
- (2) Increase the separation between the equipment and receiver.
- (3) Connect the equipment into an outlet on a circuit different from that to which the receiver is connected.
- (4) Consult the dealer or an experienced radio/TV technician for help.

FCC Radiation Exposure Statement

This equipment complies with FCC radiation exposure limits set forth for an uncontrolled environment.

This equipment is a handheld device.

4. Product overview

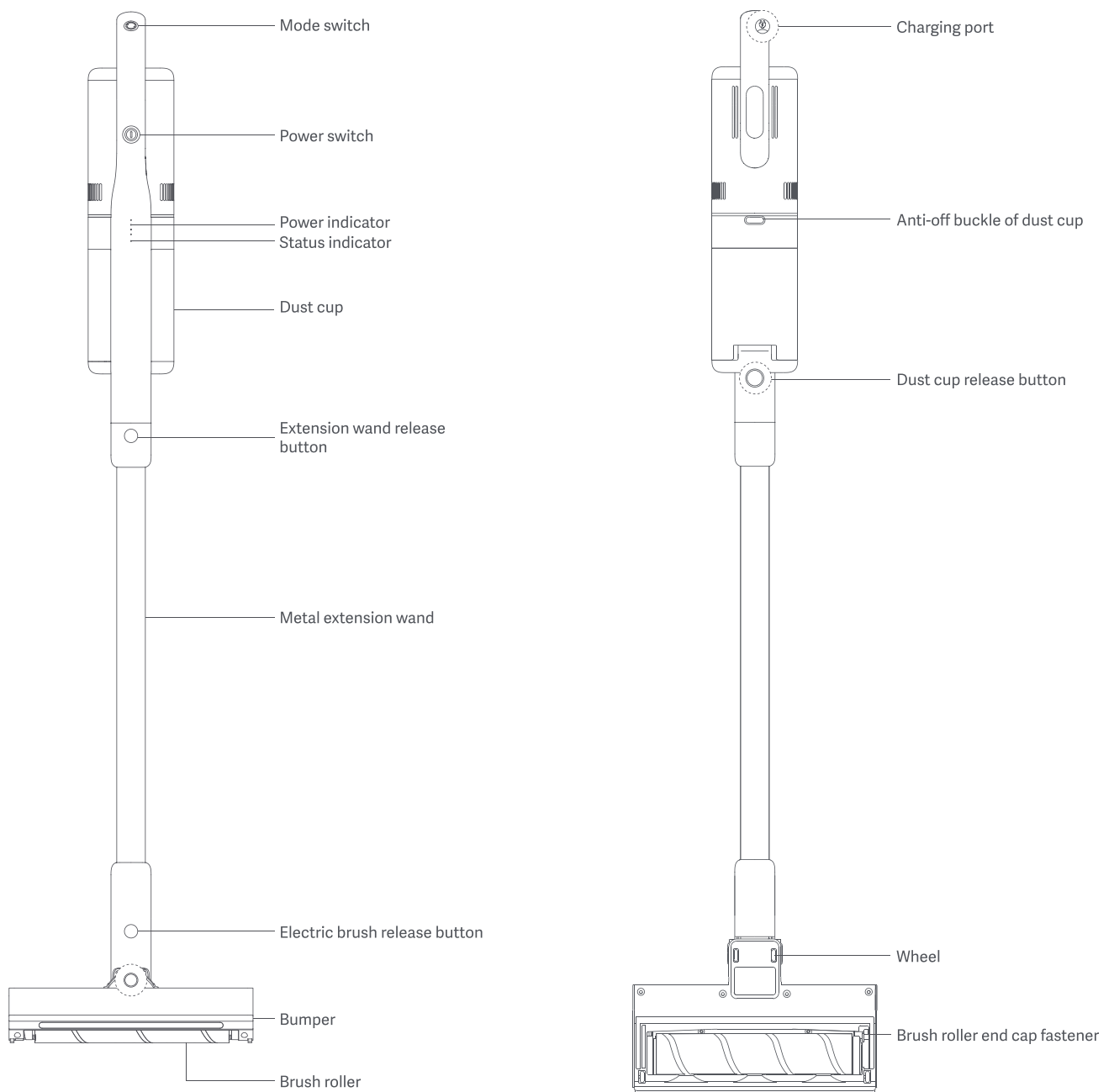

5. Parts and accessories

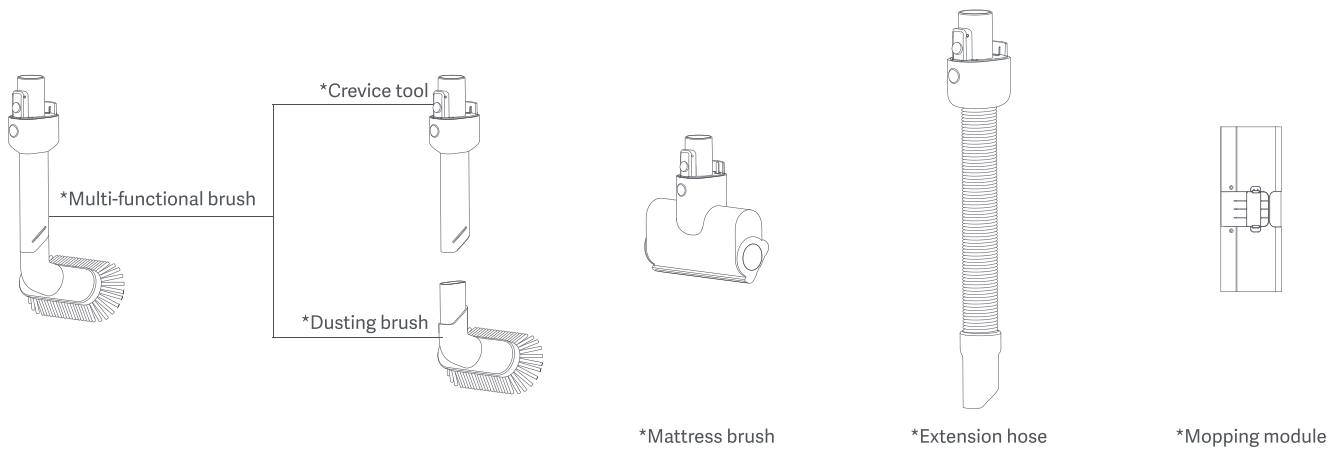



Magnetic wall mount



*HEPA filter



Cleaning brush

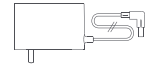

Power adapter

→ *For actual items included, please refer to the packing list.

6. Assembly

a) Assembling your vacuum cleaner

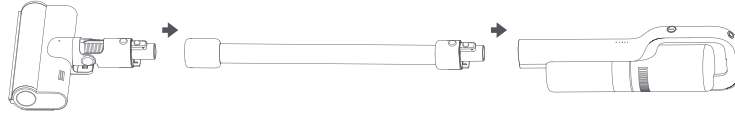

b) Assembling accessories

There are a variety of accessories that are compatible with this vacuum cleaner. Attach desired accessory or cleaning tool to the vacuum cleaner for specific cleaning purpose.

1. Attaching crevice tool: Insert release button end of the crevice tool into the main unit. Push it in until it clicks securely into place.
2. Attaching dusting brush: Insert the dusting brush into the crevice tool. Push it in until it secures into place.

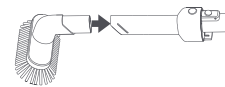
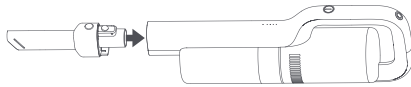

→ Accessories which can be directly connected to the main unit include extension hose and mattress brush. The method for attaching them is the same as for attaching the crevice tool. The dusting brush can also be attached to the extension hose, in the same way as for attaching it to the crevice tool.

c) Installing magnetic wall mount

Magnetic wall mount is designed to store the vacuum cleaner while not in use.

Method 1: Installing with screws



Make sure there are no gas, water or electrical pipes/wires behind the mounting area before drilling.

1. Turn the wall mount cap anticlockwise to remove the cap. At a height of 92 cm, position the base on the wall and mark the fixing hole positions. Make sure fixing holes are on a horizontal line. Drill fixing holes and hammer wall plugs into the holes. Put the base in place and fix it with screws.
2. Snap the wall mount cap back in place and turn clockwise to tighten it.

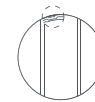
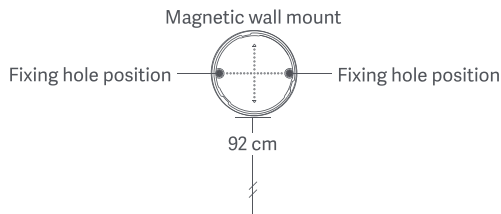

Magnetic wall mount

Method 2: Installing without screws

→ This installation method is not applicable to peeling walls, dirty walls and walls of poor quality. Ensure the wall is clean and free of dust before installing.

1. Measure a height of 92 cm and mark the installation position.
2. Remove the protective film.
3. Paste the wall mount on the wall, pressing slightly to make sure it is firmly adhered to the wall.

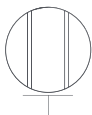

92 cm



7. Operation

a) Charging

→ Fully charge the vacuum cleaner before first use.

- To charge, connect the power adapter to the charging port on the vacuum cleaner, then connect the other end of the power adapter to a wall outlet. It takes approx. 2.5 hours to fully charge.

b) Turning on/off

- Press and hold the power switch for 1 second to turn the vacuum cleaner on. The vacuum cleaner enters STANDARD mode by default. While operating, press the mode switch or the power switch to switch between STANDARD and BOOST modes. Press and hold the power switch for 1 second again to turn it off.

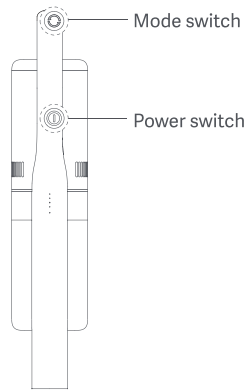

Charging	Discharging	Malfunctioning
<ul style="list-style-type: none"> ● ● ☼ ○ ○ 	<ul style="list-style-type: none"> ● ● ● ○ ○ 	<ul style="list-style-type: none"> ● ● ○ ○ ☼
<p>Remarks: ☼ indicates blinking; ○ indicates off; ● indicates constant on. When an error occurs, the status indicator blinks yellow, and 20 seconds later the vacuum cleaner turns off automatically.</p>		

c) Using accessories

Crevice tool: for tight spaces such as corners of doors, windows and stairs, etc.

Extension hose: excellent extension and flexibility to get into hard-to-reach spaces.

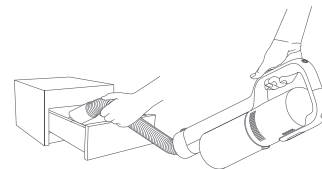
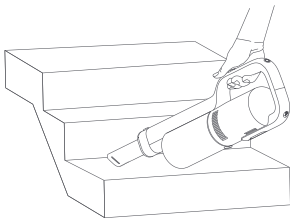

Mattress brush: for the surfaces of beds, curtains and other textile surfaces, and removing mites.

Multi-functional brush (integrated with crevice tool and dusting brush): for sofas and sofa seats, furniture, window sills and all kinds of tabletops.

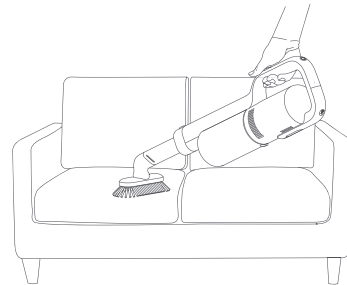
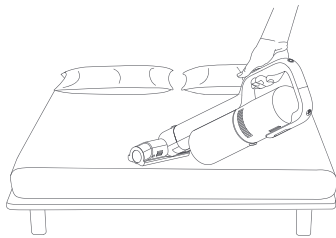

d) App

- For the best experience download and install the "roidmi cleaner" app from the App Store, Google Play or by scanning the QR code below.



System requirements: Android 4.4 or above; iOS 9.0 or above.

"roidmi cleaner" app allows you to use additional features, such as:

- Check battery power level, etc.
- Dust cup full reminder
- Vacuum cleaner firmware upgrade

Pairing:

→ Before pairing, make sure Bluetooth® connection on your phone is activated.

1. Open "roidmi cleaner" app on your phone. Tap on "Add Device" and from the list of "Nearby Device" select a device to pair.
2. Once paired, you can find the device in "Mine" -> "My Device".

8. Cleaning and maintenance



Always switch "OFF" and unplug before carrying out any maintenance.

Never use aggressive detergents, rubbing alcohol or other chemical solutions, as these may damage the casing or cause the appliance to malfunction.

a) Cleaning dust cup

1. Press and hold the dust cup release button, and pull out the dust cup from the main unit.
2. Remove as illustrated HEPA filter and cyclone from the dust cup in sequence.

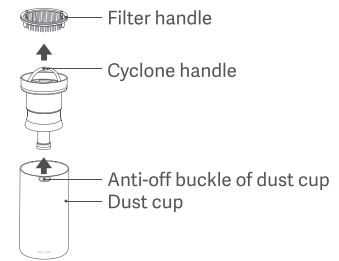
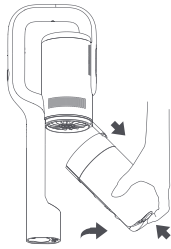

3. Empty the dust cup and use cleaning brush to clean the filter and cyclone. Wash them under running water. Air-dry completely for at least 24 hours before reinstalling.
4. As illustrated, reinstall the dust cup until it clicks into place.

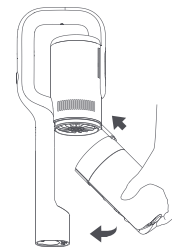
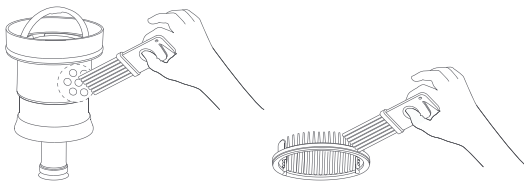

→ It is recommended to replace the filter every 3 months to maintain the highest efficiency. Use only filters specified by the manufacturer.

b) Cleaning brush roller

1. Assemble and disassemble the brush roller
Place the electric brush backside up. Pull down the end cap fastener on the right side of the electric brush. Lift up the brush roller and replace with a clean one. Insert the cap fastener into the slot until it clicks into place.
2. Clean the brush roller
Use the cleaning brush to remove hair and fibers attached to the brush roller. Wash it under running water. Air-dry completely for at least 24 hours before reinstalling.

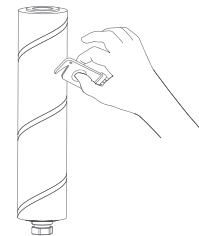
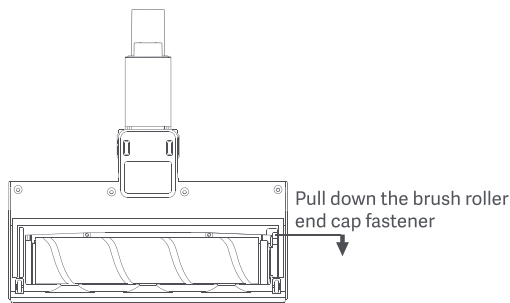

9. Troubleshooting



To reduce the risk of shock and unintended operation, turn off power and unplug the appliance before servicing.

Problem description	Possible cause	Possible solution
Brush roller does not spin	Brush roller wrapped by hair, fibers and other long impurities	Remove impurities entangled on the brush roller
Motor does not work	Low battery	Charge the vacuum cleaner
	Dust cup full of dust	Empty the dust cup
	Vacuum cleaner overheats due to extended runtime	Restart after cooling
Poor suction	Filter full of dust	Clean or change the filter
	Air inlet of brush roller or brush roller itself blocked	Clean electric brush
	Cyclone blocked by paper or wool fibers	Regularly check and clean cyclone
	Air channel between dust cup and main unit blocked	Regularly check and clean air channel between dust cup and main unit
Indicator light of charger not on or not blinking during charging	Power adapter not plugged in properly	Plug in power adapter properly

→ In any other case or if the solution explained above did not solve the problem, please contact us at service@roidmi.com.

10. Technical data

a) Vacuum cleaner

Product model	XCQ03RM	XCQ04RM	XCQ05RM/XCQ17RM	XCQ08RM
Electric brush model	XCQDS01RM	XCQDS01RM	XCQDS02RM	XCQDS04RM
Rated operating voltage	28.8 V ⁼⁼	28.8 V ⁼⁼	22.2 V ⁼⁼	29.6 V ⁼⁼
Rated charging voltage	34.2 V ⁼⁼	34.2 V ⁼⁼	25.8 V ⁼⁼	34.2 V ⁼⁼
Lithium battery capacity	2500 mAh / 72 Wh	2500 mAh / 72 Wh	2200 mAh / 48 Wh	2200 mAh / 65 Wh
Rated power	380 W (Vacuum cleaner)	380 W (Vacuum cleaner)	265 W (Vacuum cleaner)	380 W (Vacuum cleaner)
Rated power	35 W (Electric brush)	35 W (Electric brush)	35 W (Electric brush)	35 W (Electric brush)
Charging time	approx. 2.5 hours	approx. 2.5 hours	approx. 2.5 hours	approx. 2.5 hours
Running time	approx. 55 mins (STANDARD mode)	approx. 55 mins (STANDARD mode)	approx. 40 mins (STANDARD mode)	approx. 50 mins (STANDARD mode)
Running time	approx. 10 mins (BOOST mode)	approx. 10 mins (BOOST mode)	approx. 10 mins (BOOST mode)	approx. 10 mins (BOOST mode)
App function	Supported	Supported	Not supported	Not supported
Dust cup capacity	approx. 0.4 L	approx. 0.4 L	approx. 0.4 L	approx. 0.4 L
Noise	<83 dB(A)	<83 dB(A)	<83 dB(A)	<83 dB(A)
Dimensions	1191 x 259 x 158 mm	1191 x 259 x 158 mm	1191 x 259 x 158 mm	1191 x 259 x 158 mm
Weight (net)	approx. 2.6 kg	approx. 2.6 kg	approx. 2.3 kg	approx. 2.6 kg
Certifications	/			

b) Power adapter

Product model	XCQ03RM/XCQ04RM	XCQ05RM/XCQ17RM	XCQ08RM
Rated input voltage	100-240V~	100-240V~	100-240V~
Rated input current	1.0A	0.8A	1.0A
Rated output voltage	34.2 V ⁼⁼	25.8 V ⁼⁼	34.2 V ⁼⁼
Rated output current	1.0A	1.0A	1.0A
Product model	Sydkorea: RM-C-Y01KR, European Union: RM-C-Y01EU, Australia: RM-C-Y01AU, United Kingdom: RM-C-Y01UK, United States: RM-C-Y01US, Japan: RM-C-Y01JP, Taiwan: RM-C-Y01TW, China: YCQDY01RM	Sydkorea: RM-C-Y02KR, European Union: RM-C-Y02EU, Australia: RM-C-Y02AU, United Kingdom: RM-C-Y02UK, United States: RM-C-Y02US, Japan: RM-C-Y02JP, Taiwan: RM-C-Y02TW, China: RM-C-Y02CN	Sydkorea: KA3601A-3421000KR, European Union: KA3601A-3421000EU, Australia: KA3601A-3421000AU, United Kingdom: KA3601A-3421000BS, United States: KA3601A-3421000US, Japan: KA3601A-3421000JP, Taiwan: KA3601A-3421000TW, China: KA3601A-3421000CN European Union: RM-C-Y01EU, United Kingdom: RM-C-Y01UK, United States: RM-C-Y01US, Australia: RM-C-Y01AU, Korea: RM-C-Y01KR, Japan: RM-C-Y01JP, Taiwan: RM-C-Y01TW

11. Disposal

Correct disposal of this product	
	This marking indicates that this product should not be disposed with other household wastes throughout the EU. To prevent possible harm to the environment or human health from uncontrolled waste disposal, recycle it responsibly to promote the sustainable reuse of material resources. To return your used device, please use the return and collection systems or contact the retailer where the product was purchased. They can take this product for environmental safe recycling.

12. Warranty and limitations of liability

This product is guaranteed for a period of 24 months (defined by local law) from the date of purchase against any failure resulting from manufacturing or material defects.

This warranty does not cover damage caused by improper installation, improper use, or normal wear and tear of the product.

More specifically, the warranty does not cover:

- Damage or problems caused by improper use, accident, alteration or electrical connection of improper intensity or voltage.
- Modified products, those whose warranty seal or serial number have been damaged, altered, removed or oxidized.
- Failure of the battery due to overcharging or failure to observe the safety instructions explained in the instruction manual.
- Cosmetic damage, including scratches, dents, or any other element.
- Damage caused by any intervention carried out by an unauthorised person.
- Defects caused by normal wear and tear or due to normal ageing of the product.
- Software updates due to a change in network settings.
- Product failures due to the use of third party software to modify, change or adapt the existing software.
- Product failures caused by use without accessories approved by the manufacturer.
- Oxidised products.

Terms and conditions of implementation:

To obtain a warranty service, you are requested to return your product to the customer service desk of your retail outlet with your proof of purchase (receipt, invoice, ...), the product and its supplied accessories, with its original packaging.

It is important to have the date of purchase, the model and the serial or IMEI number on hand as information (this information usually appears on the product, the packaging or your proof of purchase).

Failing this, you must return the product with the accessories necessary for its proper operation (power supply, adaptor, etc.).

In the event that your claim is covered by the warranty, the after-sales service may, within the limits of local law, either:

- Repair or replace defective parts.
- Exchange the returned product with a product that has at least the same functionality and that is equivalent in terms of performance.
- Refund the product at the purchase price of the product mentioned on the proof of purchase.

If one of these 3 solutions is used, this does not give rise to the extension or renewal of the warranty period.



Made in China

Manufacturer: ROIDMI Information Technology Co., Ltd.

Address: 4F, C8 Building, No. 1699 Huishan Road, Life Science and Technology Park, Huishan District, Wuxi, Jiangsu, PRC

Executive standards:

Draft EN 301 489-1:V2.2.0:2017, Draft EN 301 489-17:V3.2.0:2017, EN 300 328 V2.1.1:2016, EN60335-1:2012/A13:2017, EN 60335-2-2:2010/A1:2013, EN 62233:2008, EN 62479:2010, EN 55014-1:2017, EN 55014-2:2015, EN 61000-3-2:2014, EN 61000-3-3:2013

UL1017 - Standard for Vacuum Cleaners, Blower Cleaners, and Household Floor Finishing Machines

FCC 47 CFR Part 2 2017, Subpart J FCC 47 CFR Part 15 2017, Subpart C

CSA-C22.2 No. 243-17 - Standard for Vacuum Cleaners, Blower Cleaners, and Household Floor Finishing Machines IC Regulation ICES-003: Issue 6 ANSI C63.4-2014

Illustrations may differ from actual product. We are constantly striving to improve our products; therefore the specifications contained herein are subject to change without notice.

Service email: wprm@roidmi.com

Corporate website: www.roidmi.com/en

For product sales information, please check the website: www.roidmi.com/en

XCQ03RM_XCQ04RM_XCQ05RM_XCQ17RM_XCQ08RM_UM_EN_V1.0