



Date: _____ Type: _____
 Client: _____
 Project: _____

CTL610 Track Light

Shown with LA630 Cone shade

Universal Design - line voltage fixture

- Universal lamp holder with exposed lamp has adjustable socket position for proper seating of various lamp types and shades
- Fixture measures 7" high x 4 3/4" deep x 4 3/4" dia.
- 75 watt PAR 30 lamp recommended or LED option available
- Fixture available in black, white or silver

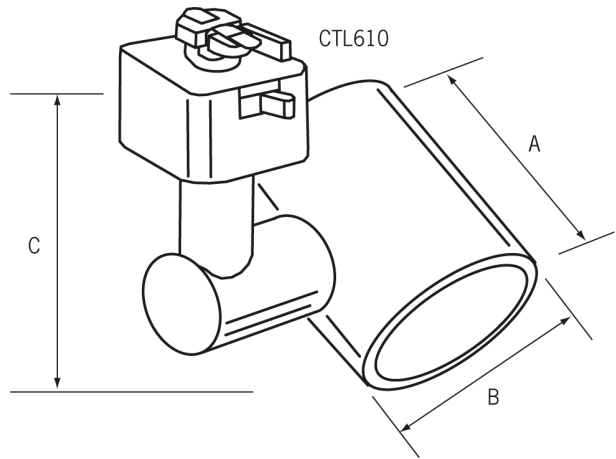

Product Advantages:

- Versatile multidirectional line voltage fixture
- Holds desired position securely
- Uses variety of lamp styles to deliver desired effects

Other views



Lamp holder without shade



LA620 - shade



LA6838 - shade



LA638 - lamp collar

Related Products



Track



CLLA6 - End feed w/ cord & plug



CLLA2 - Mini connector



CLLA3 - Flexi-connector



Replacement lamps



CLLA12 - Straight/L connector



CLLA15 - T Connector



Power strips

DIMENSIONS			
Model	A	B	C
CTL610	2-3/4"	2-1/4"	4-7/8"
CTL610/LA620	4-1/2"	3-1/2"	6-1/2"
CTL610/LA630	4-3/4"	4-3/4"	7"
CTL610/LA638	3-3/4"	2-1/4"	5-3/4"
CTL610/LA6838	6-7/8"	5-7/8"	9"



Display Supply & Lighting, Inc.

Display Supply & Lighting, Inc.
 1247 Norwood Avenue
 Itasca, IL 60143 USA
 TF 800.468.1488
 P 630.285.9660
 F 630.285.9670
 www.dslgroup.com

Copyright © 2016 Display Supply & Lighting, Inc. All rights reserved. All brand or product names are trademarks or registered trademarks of their respective owners. Due to continuous improvements and innovations, specifications may change without notice.