

Date: _____ Type: _____

Client: _____

Project: _____



1' x 2' LED FLEX PANEL

CETILETUNTNW-R2: Tunable - White

CETILETUNDTW-R2: Dim to Warm

Flexible and Dimmable

1' x 2', Tunable - LED Flex Panels provide a single, dimmable and adjustable color temperature to deliver illumination that can replicate natural light in scale and through dynamic changes in color temperature

- Suited for installations requiring high CRI such as retail and hospitality.
- Tunable White delivers the desired lumen output at all CCT's within the tunable range (5700K - 2200K) and can be dimmed without changing the CCT.
- Dim-to-warm product option provides smooth dimming along the CCT curve to 0.05% from 3500K to 2200K.
- Provides constant lumen output at all CCTs in the range of 2700K to 5700K and at all dimming levels.
- 1' x 2' LED Panels can be scaled to fit any space or cut on site to accommodate corners, angles, and obstacles such as standoffs, posts, sprinklers or support cables and rods. Optional panel cut-out kits and corner kits are available to assist with unique obstacles and geometries.
- 1' x 2' LED Flex Panels do not require any heat sinks, so they can be mounted to any material.
- LED driver can power a single panel or a large number of panels (depending on lumen output of panels). A dimmer can be added to circuit.
- Constant voltage design means that layout changes required to meet on site conditions don't require re-sizing power sources.
- Color Rendering (CRI): >90 (except 2200K, CRI 88)
- Required accessories: LED Driver, Tunable T-Cable, and Tunable Starter Cable, and Control Module
- Optional accessories: Tunable Cut-out Kit
- UL Listed



Light Output (lm/sqft)	Color Temperature (CCT)	Power (W/sqft)
600	2200K	6.5
	2700K	5.9
	3500K	5.3
	5700K	5.0
300	2200K	3.1
	2700K	3.0
	3500K	2.7
	5700K	2.5
150	2200K	1.5
	2700K	1.5
	3500K	1.3
	5700K	1.2



Display Supply & Lighting, Inc.
 1247 Norwood Avenue
 Itasca, IL 60143 USA
 TF 800.468.1488
 P 630.285.9660
 F 630.285.9670
 www.dslgroup.com

Display Supply & Lighting, Inc.

1' x 2' LED FLEX PANEL

Tunable - White

Date: _____ Type: _____

Client: _____

Project: _____

1' x 2' Flex Panel (Interior) System Overview

- 1 **TILE Interior**
Flexible light emitting sheet
- 2 **TILE Interior Cut-out Kit (optional)**
Cut-to-fit TILE and wiring for obstacles.
- 3 **TILE Interior T-Cable (required)**
Connects the first TILE in each run to the Starter Cable.
- 4 **TILE Interior Starter Cable (required)**
Connects the Control Module (or Power Supply) to the T-Cable (Included in TILE Interior Starter Kit)
- 5 **Power Supply (required)**
Converts AC mains (line) power to low voltage (58VDC) power.
- 6 **Control Module (optional*)**
Receives input control signals using industry standard control protocols to dim up to 4 @ 90W output channels.
* Required for use with 200W and 400W power supplies

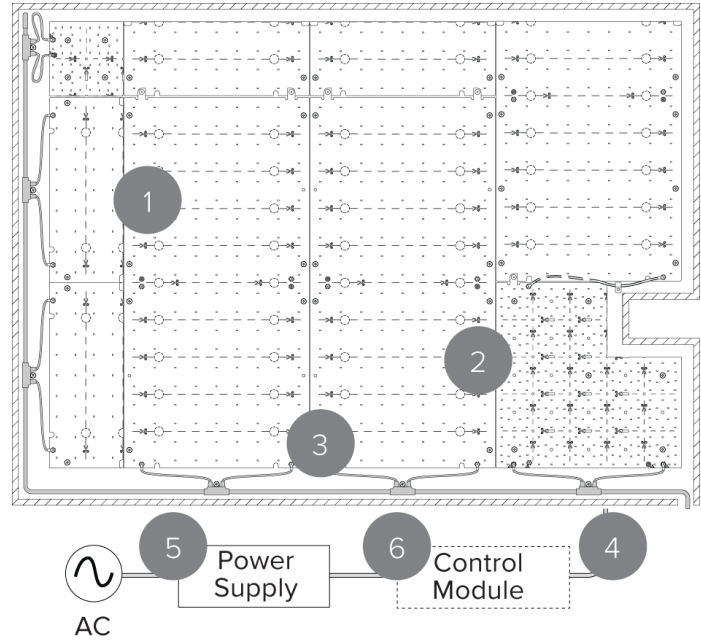

1 TILE TUNABLE WHITE

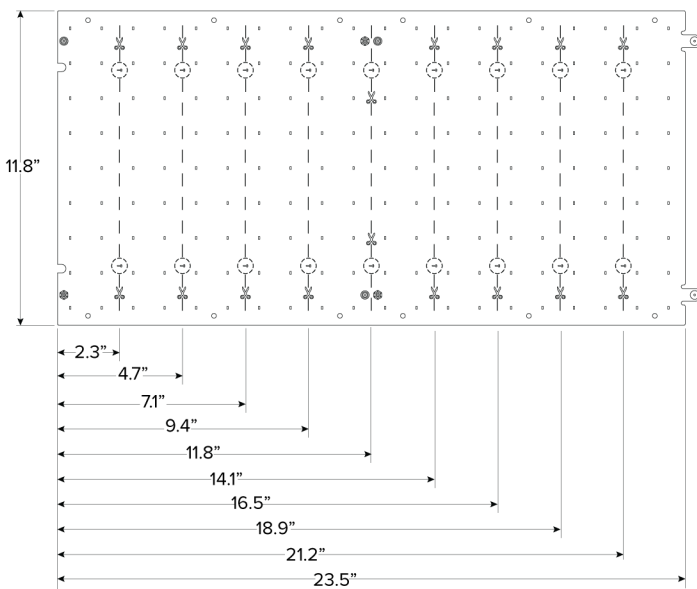

Weight = 0.19bs/ 86g

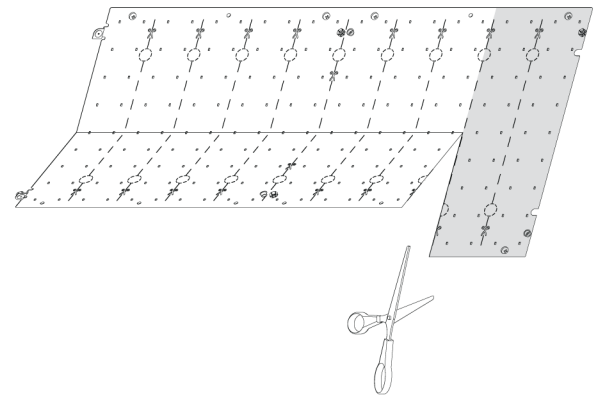

Display Supply & Lighting, Inc.
1247 Norwood Avenue
Itasca, IL 60143 USA
TF 800.468.1488
P 630.285.9660
F 630.285.9670
www.dslgroup.com

Display Supply & Lighting, Inc.

1' x 2' LED FLEX PANEL

Tunable - White

Date: _____ Type: _____

Client: _____

Project: _____

2 TILE TUNABLE WHITE CUT-OUT KIT

Purpose: Cut-to-fit around obstacles located in a luminous surface such as standoffs, support cables/rods, beams, pipes, etc.; used in corners where a full TILE does not fit in the space; or to step cut along angles and curves at the edge of a luminous surface. (Optional)

INCLUDED

- (1) Cut-out TILE (11.8" x 11.8")
- (2) Insulating Patches
- (1) Cable Clamp
- (1) Jumper Cable

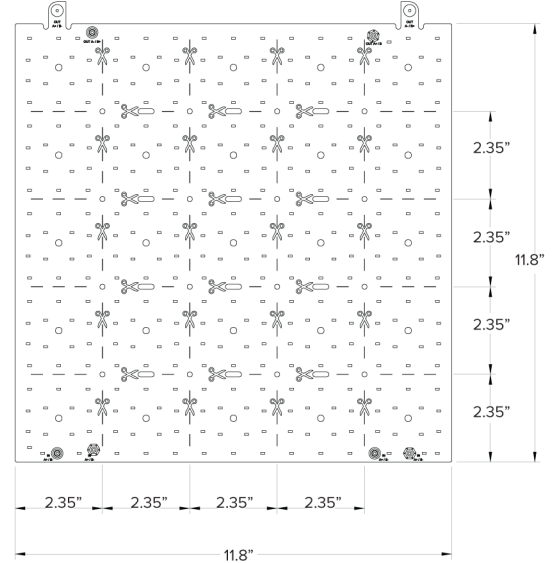
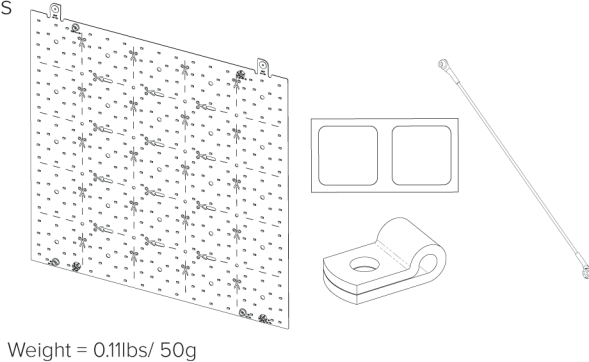

3 TILE TUNABLE WHITE T-CABLE

Purpose: Makes the electrical connection to the first TILE in each run from the Starter Cable that supplies power from the power/control components. Each "T" connects to a TILE via snap connectors. (Required)

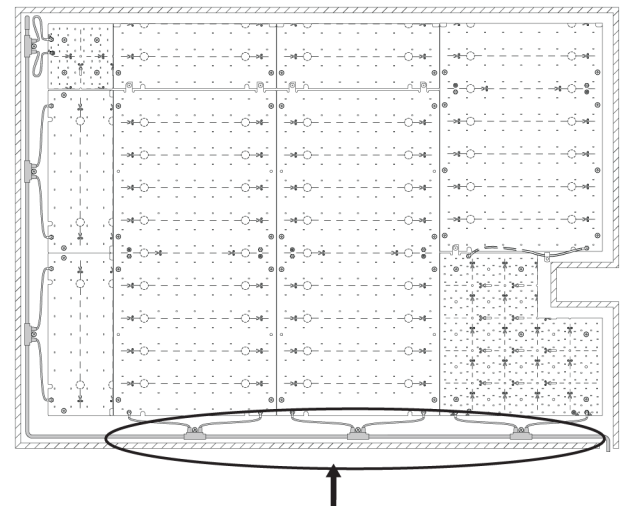

Display Supply & Lighting, Inc.

Display Supply & Lighting, Inc.
 1247 Norwood Avenue
 Itasca, IL 60143 USA
 TF 800.468.1488
 P 630.285.9660
 F 630.285.9670
 www.dslgroup.com

1' x 2' LED FLEX PANEL

Tunable - White

Date: _____ Type: _____

Client: _____

Project: _____

4 TILE TUNABLE WHITE STARTER KIT

Purpose: Includes the Starter Cable that makes the connection from the Control Module to the T-Cable and other accessories required for wire termination and connections. Insulation patches are required to cover areas of TILES where cuts have been made. (Required)

INCLUDED

- (4) Cut TILE Reuse Jumper Cable
- (2) Splice Connectors
- (4) End Caps
- (10) Insulating Patches
- (1) 16 AWG (1.3mm²) Cable, 10ft (3m) Length
- (1) Quick Start Guide

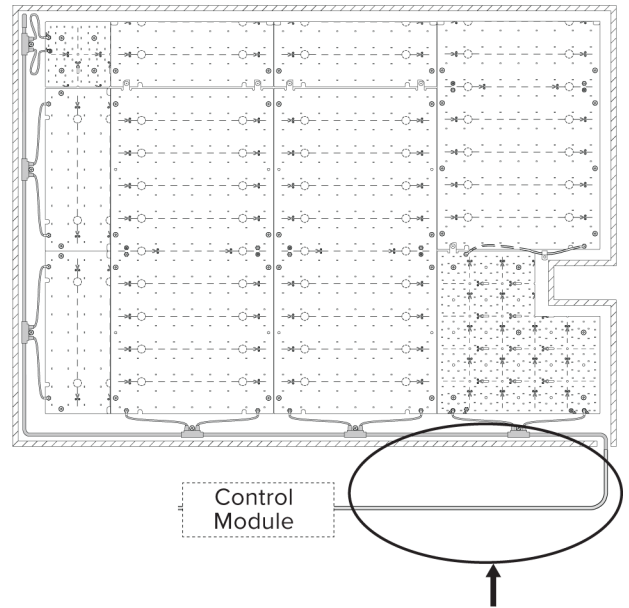
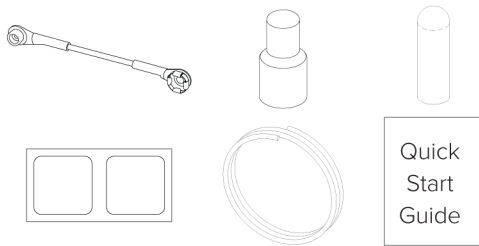

5 POWER AND CONTROL

- Power and Control Specifications (UL Listed)

The models shown below are those that are compatible with TILE Tunable White Systems for regions where cUL Listed products are required.

POWER SUPPLIES (58V)

Purpose: Convert AC main (line) power to safe, low voltage DC power. LED drivers are offered with range of dimming options. (Required)

Order Code	# Controller Channels *	Enclosure
EPSS-200-58V	2	Yes

*Class 2 (max 90W) output



Display Supply & Lighting, Inc.

Display Supply & Lighting, Inc.
 1247 Norwood Avenue
 Itasca, IL 60143 USA
 TF 800.468.1488
 P 630.285.9660
 F 630.285.9670
 www.dslgroup.com

1' x 2' LED FLEX PANEL

Tunable - White

Date: _____ Type: _____

Client: _____

Project: _____

CONTROL MODULES (58V)

Purpose: Receives 58VDC power from the power supply and converts it to max. 90W per channel of controlled output to drive TILE Interior sheets. Also receives input control from one of 4 protocol options to control dimming levels.

Order Code	Function	Protocols
CTR-TNW-DAL-58V	Tunable White	0-10V, DALI
CTR-TNW-DMX-58V	Tunable White	DMX
CTR-TNW-CAS-58V	Tunable White	Casambi (Wireless)
CTR-DTW-DAL-58V	Dim-to-Warm	0-10V, DALI
CTR-DTW-DMX-58V	Dim-to-Warm	DMX
CTR-DTW-CAS-58V	Dim-to-Warm	Casambi (Wireless)

ADDITIONAL ACCESSORIES

EXTENSION CABLES

- 16 AWG cable (non-plenum rated)
- Available in 10' & 20' lengths

Purpose: Cable between TILE Starter Cable and Control Module that extends the distance the Control Module and power supply may be remotely located away from the TILES. Please call for additional information including requirements for plenum rated cables.

