



Display Supply & Lighting, Inc.

What does DS&L offer to you?

DS&L has been serving the
trade show and experiential industries for 45 years

Headquartered in Itasca, IL, DS&L has personnel in IL, MA, Western NY & NV

DS&L provides:

- Reliable, high quality lighting and supply products
- Lighting layout and design and product selection assistance
- Specialty lighting rental program
- Application Engineering Services, including:
 - Programming services
 - On site installation oversight
 - Project coordination



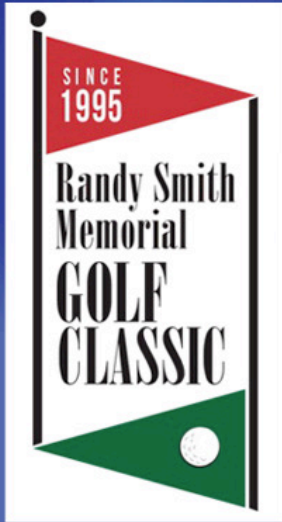

Giving Back and Supporting Our Industry



DS&L can do more than just sell you products

As your Collaboration Partner...

DS&L will:

- Assist in bringing your designs to life by understanding your goals and objectives and searching out solutions to meet your budget
- Work with you on pricing when jobs are tight on margin
- Support you in the use of products – from prototyping, to production, to installation, to use
- Care about more than just “this sale” – we are committed to building our relationship and are always working on the future of our relationship

All we ask:

- Respect our efforts and work
- Please do not share our design ideas and bill of materials with others – this is our “IP”



It's not about what the product costs – it's all about what it costs to use the product!

The total cost to use a product consists of:

- Time to source correct product
- Cost of product
- Labor time and materials to assemble the product and install it for use
- Cost to repair the product if damaged on show floor/site - if skill set to repair is on site

**You are better off paying more up front (if necessary) to have a reliable,
easy to use solution**



DS&L INNOVATION

DS&L creates innovative products designed for use in the trade show, experiential and live event industries

Our lighting and supply products are designed for performance and ease of use – and to be concealed within your designs. A few of our recent innovations include:



Flat cord with mini ends

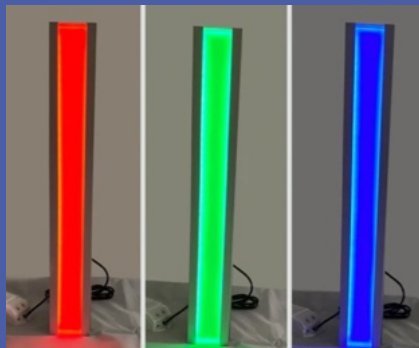

RGB End Cap



Mini Power Grommet



Slim and Gimbal Recessed with CCT select

DS&L also partners with technology leading companies to deliver game changing products – like high quality, rechargeable battery technology



Design Time

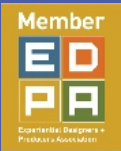

Mock Up

College hotel project

Mock up to demonstrate how to make a campus hotel visible with changing color from various parts of the college campus



ColorReach

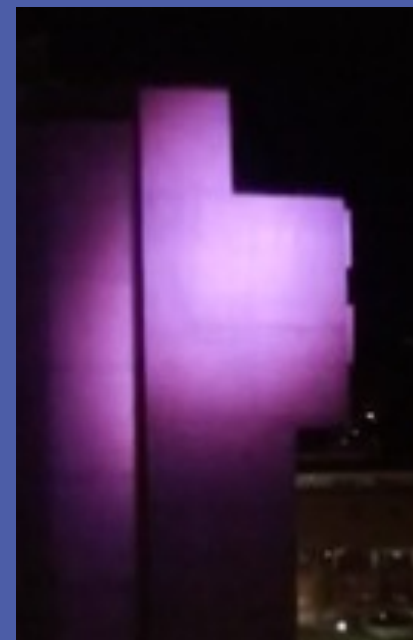
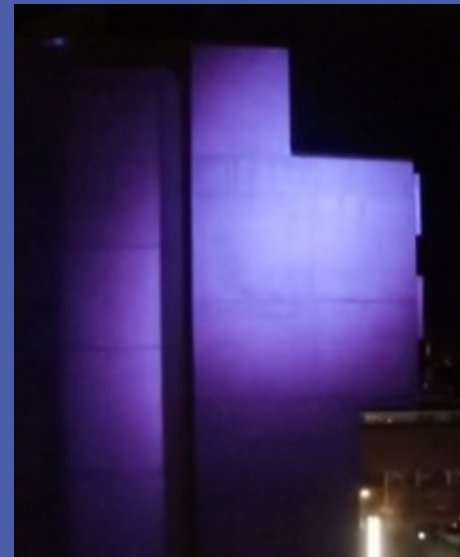
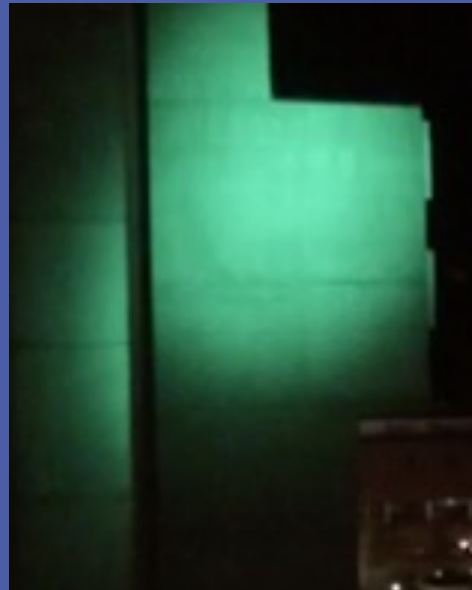
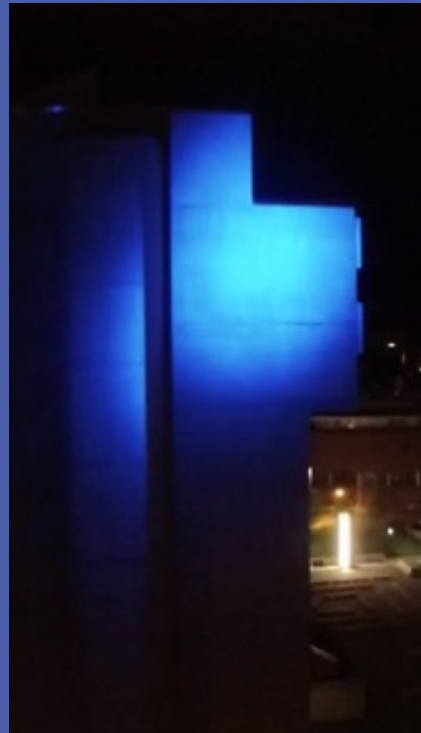

Retail

Walkway over escalator in
S. American mall

Illuminated tension fabric
structure with
synchronized changing
color fabric columns. A/E
services used for
programming and control
specifications



ColorBlast 12



fixture



© 2024 Display Supply & Lighting, Inc.

Hospitality

Conversion of hotel ballroom to restaurant using a twin rail system pendants and under bar lighting

A/E services used to coordinate layout and controls

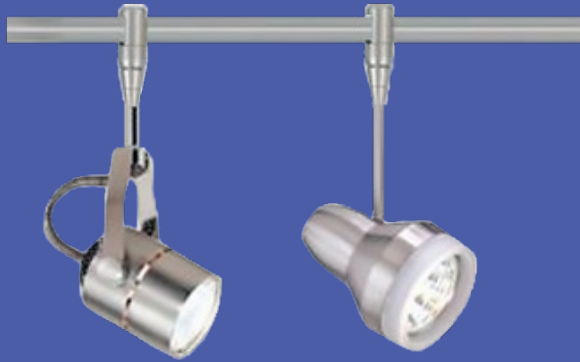

Monorail and Pendants

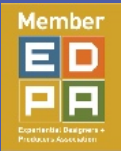

Exterior

Individually controlled LED nodes on wires to highlight architectural features of buildings

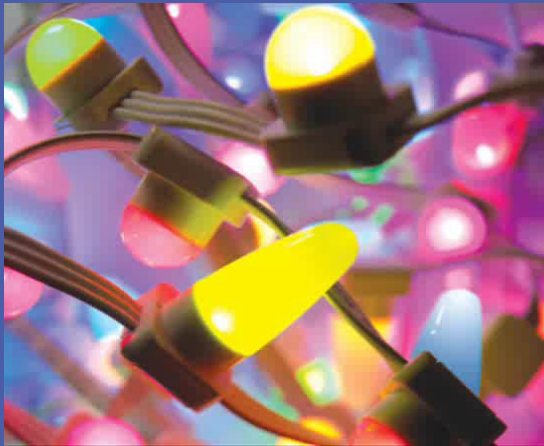

Color Kinetics LMX – LED nodes on wire – each node is individually addressable

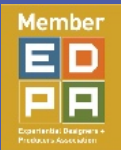

Exhibit Display

RGB changing color light in columns (on left), white light in overhead sign and LED lighting in accent areas around desks, arches and graphics



LED Tape



Exhibit Display

Custom exhibit to highlight machinery with toe kick lighting, integrate changing color into face of arches; and vibrant light boxes



LED Modular Strips



LED Tape



Architainment

Changing color light on 3 sides of structure with facing LED screens

Middle area is frozen during the winter for public skating



ColorBlast

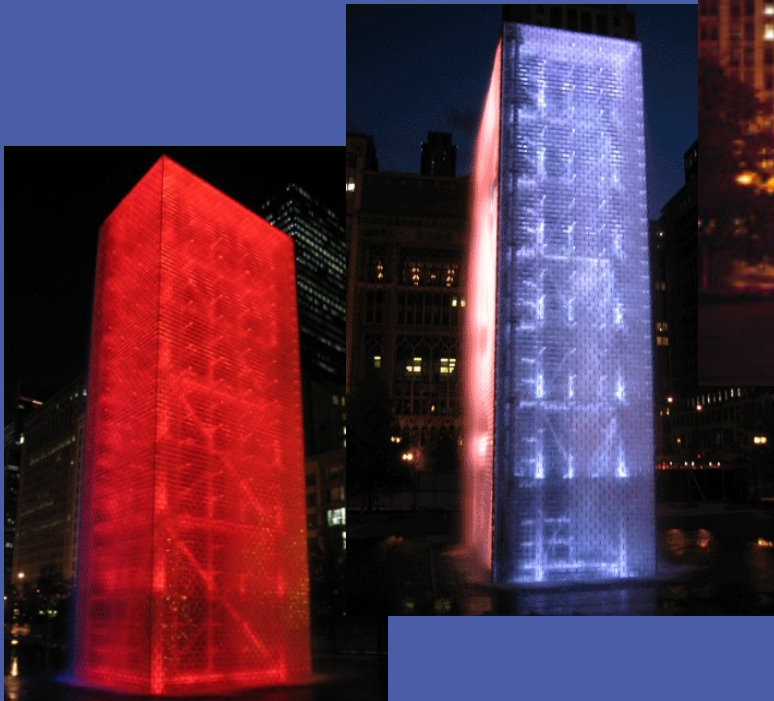

Exhibit Display

Changing color light in dome,
synchronized to band in center
of counter

A/E services used for
programming and controls



ColorBlast TR Fixture



PowerCore Cove MX



Auto Show

Changing color LED back walls

Rings under vehicles are lit with fluorescents with gel sleeves

A/E services used to oversee install, programming and controls



ColorBlast TR & ColorBlaze

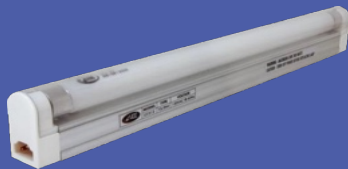

T-5 Fluorescent



Exhibit Display

Simple, but effective

LED Arm Lights to illuminate the header and soft recessed LED lighting to illuminate the workstation



LED Arm Lights

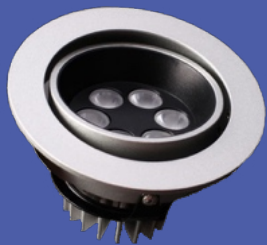

Recessed LED Lights



Exhibit Display

Color temperature select
slim recessed fixtures with
mini neon direct view
accent lighting



CCT Slim
Recessed



LED Mini
Neon

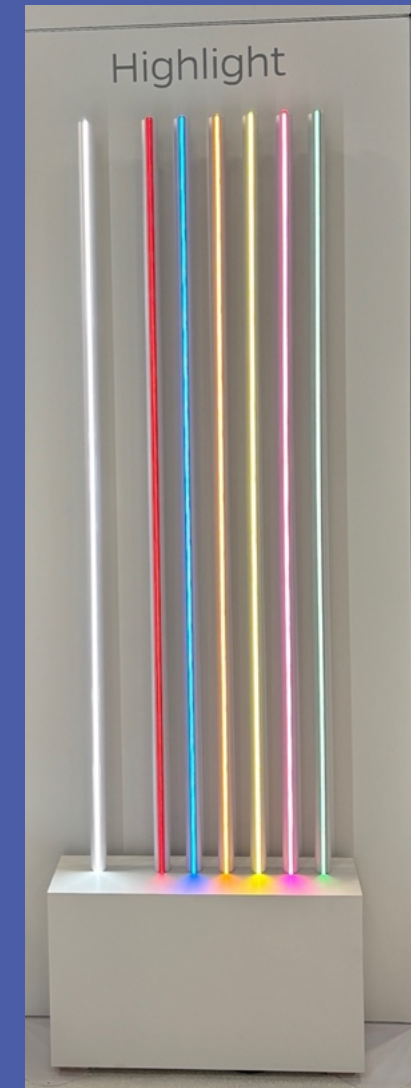
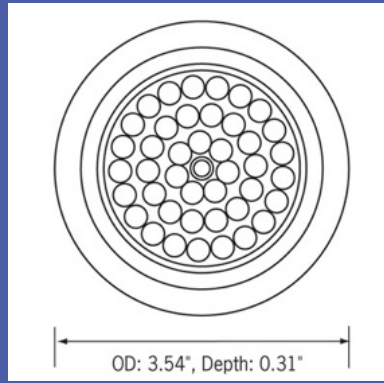

Exhibit Display

Showcases with LED accent lights used to illuminate jewelry in window displays

LED Slim Surface Mount Pucks



Retail Display

LED pucks used to light logos for the country of origin where food is being served from.

A/E team designed system with cabling and switches to control on/off functionality

LED Surface Mount Pucks



Corporate Lobby Desk

Custom RGB LED rigid panel programmed to company's color as the face of a reception desk in a corporate lobby



Exhibit Display

Light boxes and custom lighted icebergs

The unique peaks and curves of the iceberg structures presented some additional challenges that were overcome in the design stage

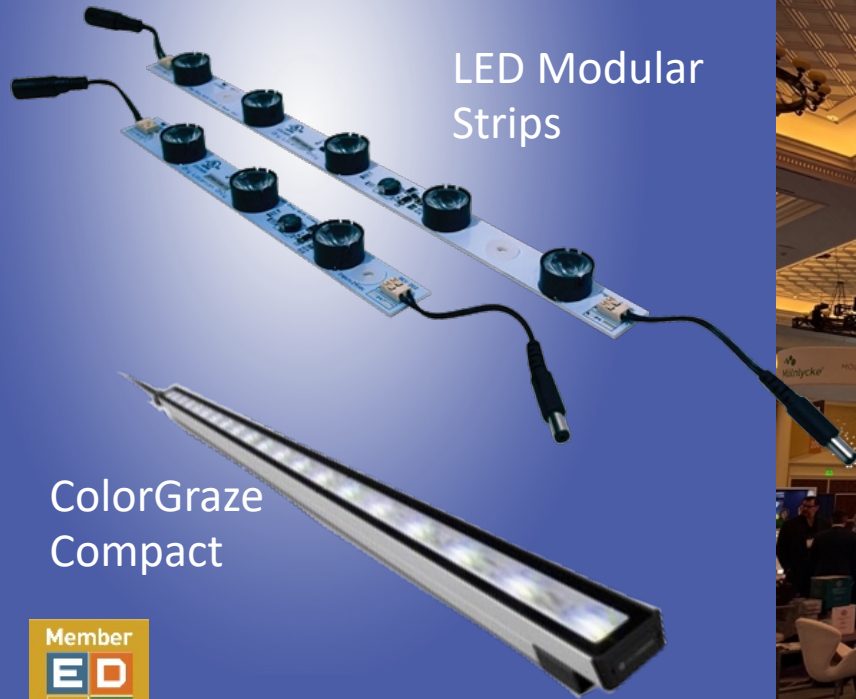

LED Modular Strips

ColorGraze Compact

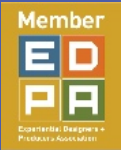

Entertainment

LED Beach Ball, Panama City, FL

Inside of beach ball illuminated with ColorBlast fixtures and seams of panels are lit with iColor Flex MX



ColorBlast

iColor Flex MX

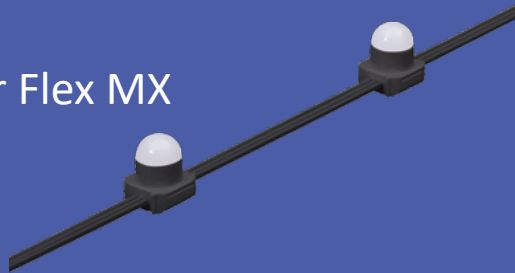

Permanent Install

Changing color RGB tape with iPlayer control at a YMCA in Grand Rapids, MI



RGB Tape



iPlayer

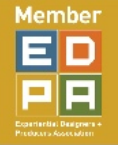
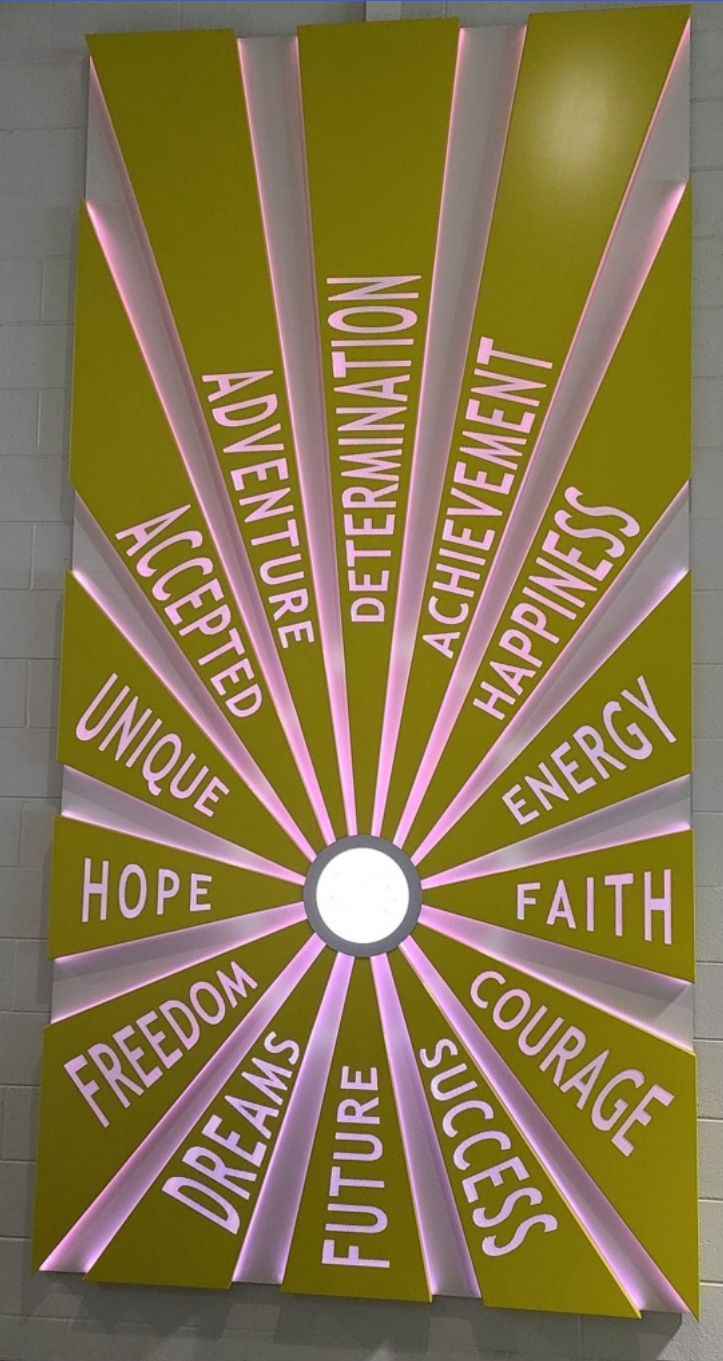

Trade Show Light Box

Vibrant white light for trade show light boxes

Recommended for 8' x 8' boxes with just perimeter lighting - graphics dictate requirement for number of lighting strips

This example is a 16' x 16' light box with just perimeter lighting.



LED Modular Strips

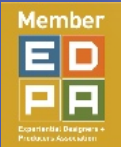

Trade Show Counter

Counter face of trade show exhibit lighted using LED Modular Strips

No shadows even on a white graphic!

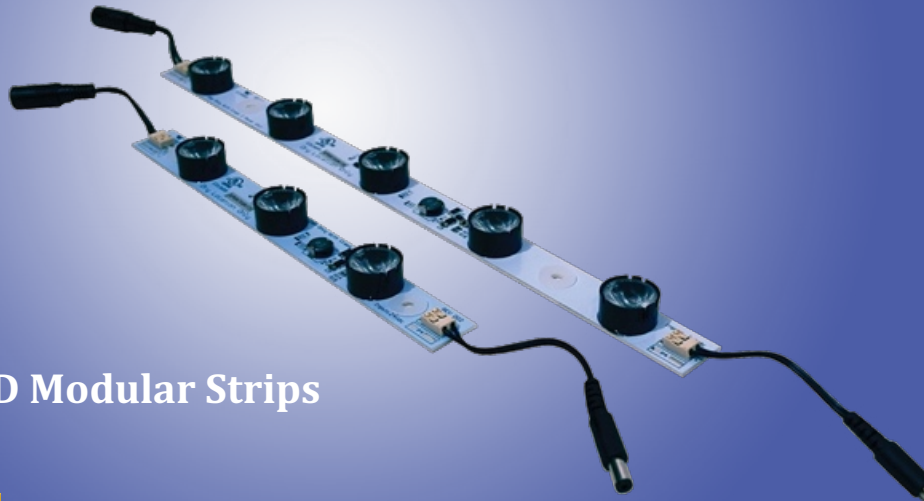

LED Modular Strips

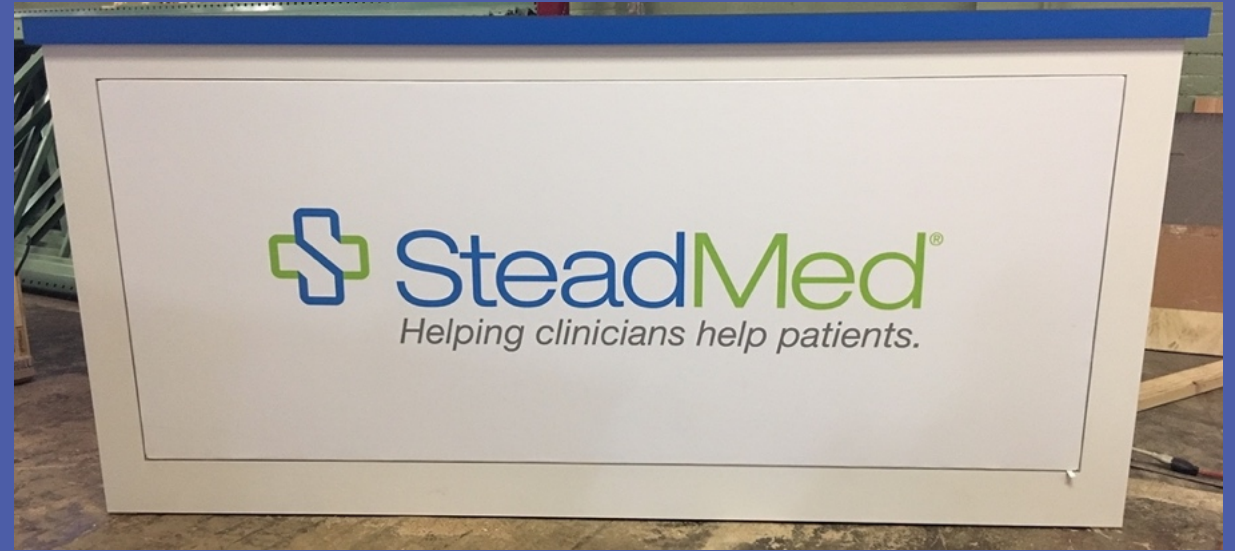

Trade Show

HO LED Tape used to illuminate shelving, provide halo glow lighting around graphics on brick wall and under mantle glow

LED Modular Strips used to illuminate large light box.

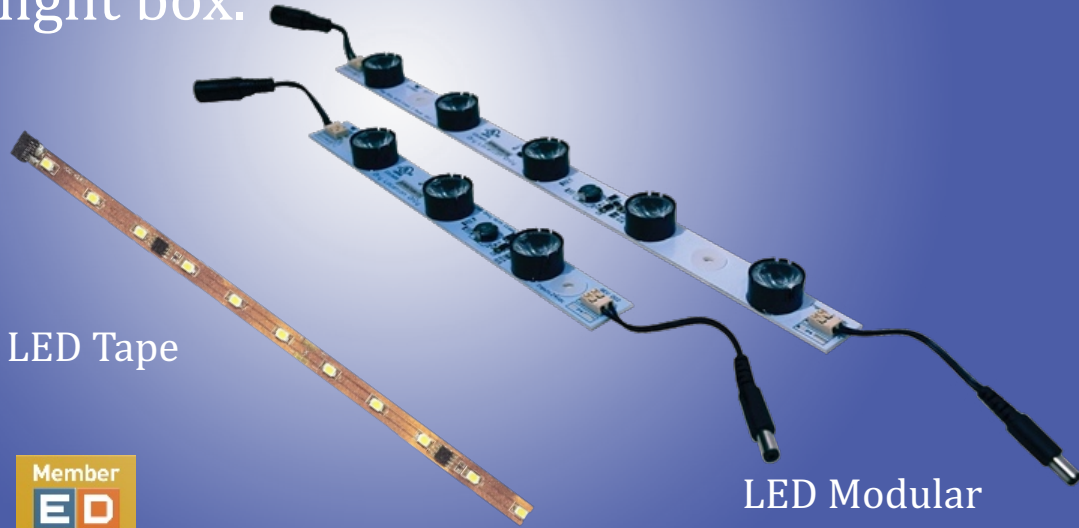

LED Tape

LED Modular Strips



Corporate Lobby

Micro profile LED fixtures used to vibrantly illuminate awards case and plexi faces and underside of trims on custom built reception desk

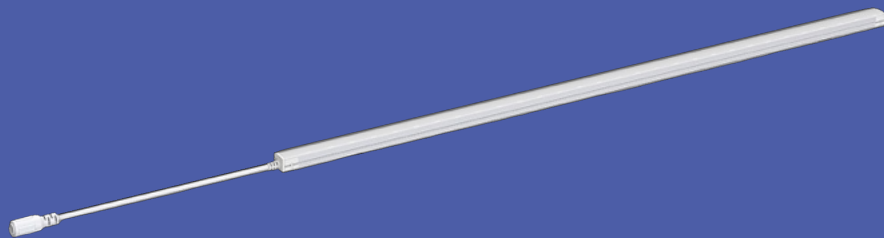

Micro Profile
LED Fixtures



Trade Show

LED Flex Panels used to back light tension fabric face of a counter



LED Flex Panels



Trade Show

Work with an exhibit house to replicate Cash Cab on a trade show floor

Specified product, handled custom programming and delivered a one of a kind experience for attendees

iColor Flex controlled via custom app on iPad

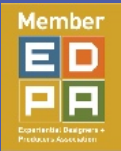
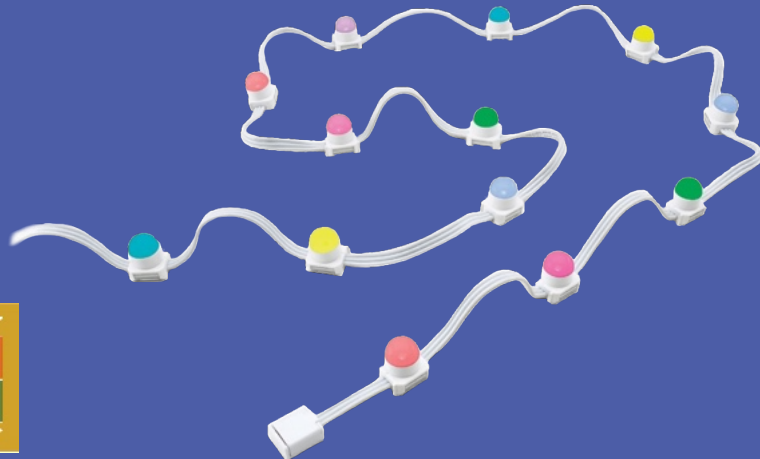

University Athletic Department

Towson University, halo
lighting around school
logo



LED Tape

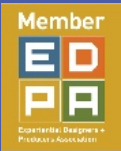

Stadium

TV broadcast studio at ballpark

White LED lighting (color temperature controllable for varying weather conditions and time of day) underside of desk has color changing light to match sponsor color and side light boxes illuminated with T5 fluorescent fixtures



A/E services used for control system



iW Blast Powercore



MX Cove
Powercore



T5 Fluorescent



Broadcast Studio

TV broadcast studio for Sports NY using a wide range of products

A/E services used to oversee install, coordinate the various technologies and program



RGB and 4K HO LED Tape



Fluorescents



LED
RGB rope light

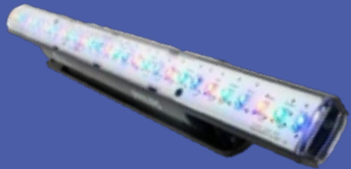

CK iColor cove QLX



Par16 "Birdes"
with barn doors



Broadcast Studio

TV broadcast desk for
ESPN's NFL Insiders set

All white lights used for
up and down lighting



LED Surface
Mounted
Disk Lights

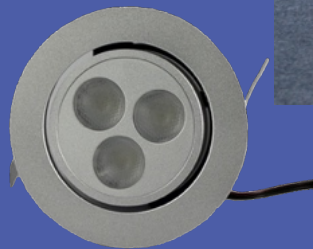

LED
Recessed
Fixtures



Exterior Sculpture

Illumination of outdoor kinetic sculpture in Dallas using powerful changing color light

Fixtures deliver a dynamic impact and complete makeover of sculpture



ColorBurst
Powercore



Worcester Ice Center

Called in to make face of building distinguishable

White LED lighting in entry area to provide good ambient light

Direct view, changing color light on face of building and wired to keypads in managers office to trigger variety of programs

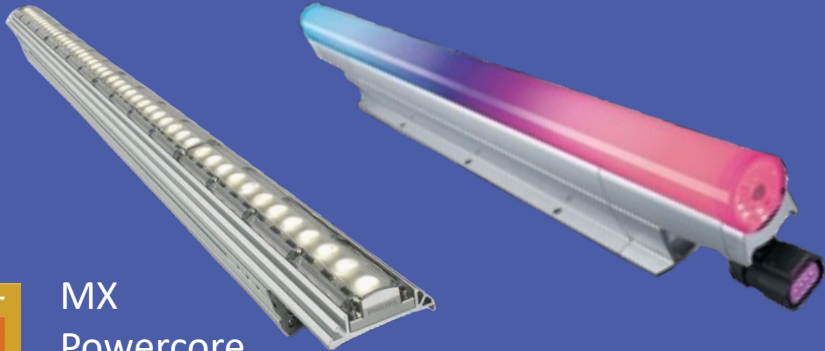

MX
Powercore

iColor Accent



Municipal Clock Tower

Worked with architect from design phase to specify a custom LED 4 sided sign for the top of a clock tower and milk plex panels with changing color edge lighting

Managed order, delivery, installation and activation of property

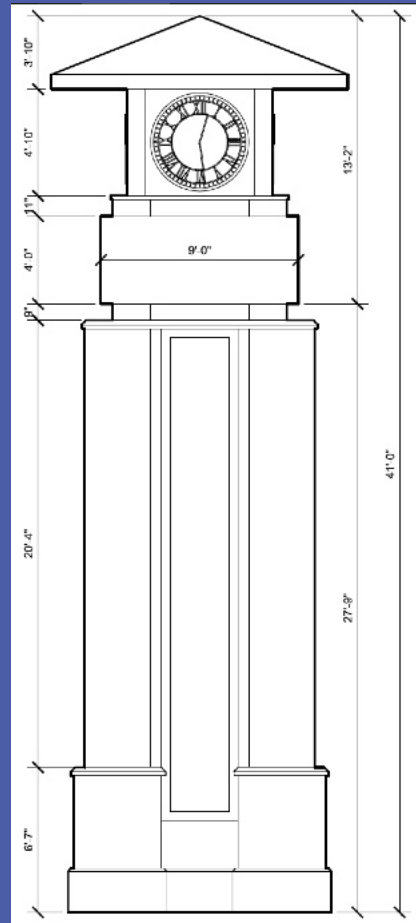

Stadium



Stadium

40' iconic, classic Coca Cola bottle

Custom 10' tall, 360 degree LED label billboard

Changing color capability throughout the bottle with control room in base

A/E services from design, to product selection, to installation oversight, to programming



ColorBlast
Powercore



Custom LED
Billboard



Flex LMX





Display Supply & Lighting, Inc.

Thank you for your (design) time!

What Can We Create Together???