

24V 250mA DOOR RELEASE POWER SUPPLY UNIT

GENERAL

The BF375P is a Mains derived power supply unit designed to provide power to 24V DC electromagnetic door retainers. It has a maximum output of 250mA.

A variety of inputs are provided for connection to all types of fire alarm control panel, building management systems, timers, relays and other ancillary equipment.

When the correct stimulus is applied to one or more of the inputs, power to the retainer(s) is removed, causing the door(s) to close.

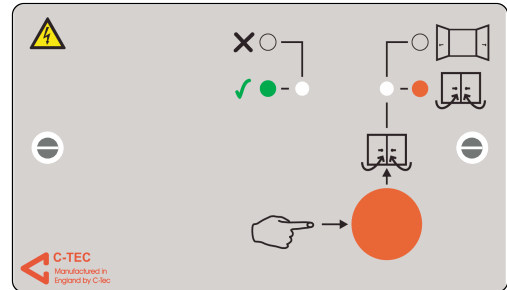

BF375P : FRONT LABEL LAYOUT

INDICATORS

The BF375P has two indicators, one green and one red.

GREEN SUPPLY HEALTHY INDICATOR: lit when the unit is supplied from the Mains.

RED OUTPUT INDICATOR: lit when the door retainers are released.

INSTALLATION

IMPORTANT NOTES:

- 1 THIS EQUIPMENT MUST ONLY BE INSTALLED AND MAINTAINED BY A SUITABLY SKILLED AND TECHNICALLY COMPETENT PERSON
- 2 THE BF375P IS NOT DESIGNED TO CHARGE BATTERIES OF ANY KIND. BATTERIES MUST NOT BE CONNECTED TO THIS UNIT
- 3 DO NOT CONNECT ANY OTHER DEVICES EXCEPT ELECTROMAGNETIC DOOR RETAINERS TO THE 24V DC OUTPUT OF THIS EQUIPMENT.

Location:

The BF375P must be sited internally and must not be placed in a damp or very dusty atmosphere.

If the Manual Test Release Button is to be used on a regular basis, the unit should be placed within reach of the person(s) designated to use it. If not, the unit can be sited in a more secure location to reduce the risk of vandalism or physical abuse.

Ambient light levels should allow the status of the BF375P's indicator lights to be clearly seen as required.

First Fix - Back Boxes:

The BF375P must be fitted to a standard UK double gang back box of at least 25mm depth that is securely fixed to a wall. The back box, in conjunction with the front plate, comprises a fire compartment and therefore must be made of flame retardant material.

Any dust created during the fixing process must be kept out of its electrical and electronic systems, and care must be taken not to damage any wiring or components.

Any apertures must be sealed off so as not to compromise the integrity of the fire compartment. i.e. any knockouts removed must be sealed with a flame retardant gland.

Comsec Protection Systems.

First Fix - Mains Wiring:

The BF375P is a piece of class 1 equipment and, as such, any metal parts used during installation (i.e. metal back box) **MUST** be earthed.

All mains wiring should be provided in accordance with the current edition of the IEE Wiring Regs, 16th Ed. (BS 7671 1993) or in accordance with the relevant national wiring rules.

The general requirement for the Mains supply to the BF375P is fixed wiring, using three core cables of not less than 0.75mm². This should be fed from an isolating switched fused spur, fused at 3A, which is marked appropriately and secure from unauthorised operation. (As an alternative to a switched fused spur, any double pole isolating device with an air gap greater than 3mm when isolated may be used).

Live and neutral should be connected to the L and N terminals respectively. If a plastic back box is used, the earth connection should be made to the terminal marked \perp at the terminal block labelled CONN2 (see diagram right). If a metal back box is used, the earth connection must be made to the earth bonding point on the back box.

All external wiring brought into the unit must be adequately insulated with PVC or Neoprene.

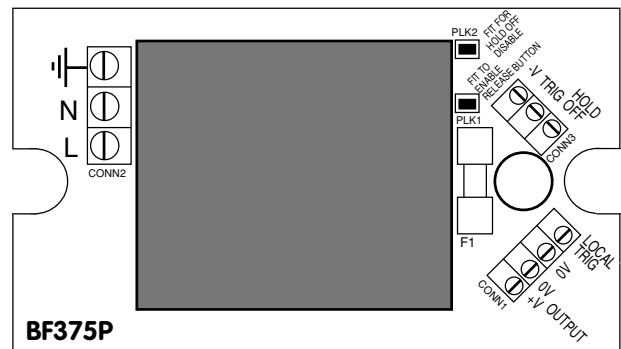

BF375P : INTERNAL PCB LAYOUT

First Fix - Low Voltage Wiring:

All low voltage wiring coming into the BF375P must be carefully planned before starting the job (see *Typical Wiring Configuration Diagrams below and on pages 3 and 4*).

Cables should be tested using a good quality meter. **Do not** use an insulation tester (Megger) with the power supply, control equipment, door retainers and any other peripheral devices present as this could seriously damage the units.

Always segregate low voltage wiring from the Mains wiring.

Important: In the event of a short circuit (not on the Mains), a low voltage fuse (F1) will blow to protect the unit from damage. When replacing this fuse, only use a 400mA T fuse, 20 x 5mm to IEC (EN60127 part 2). The BF375P is also protected by a thermal fuse in the mains winding of the transformer. This fuse will blow in an event of a serious malfunction or misuse of the unit. If this happens, the unit must be returned to the manufacturer for repair, as this part is not accessible and therefore non-replaceable by service personnel.

CONNECTING THE DOOR RETAINER(S)

A maximum of five electromagnetic door retainers (rated @ †50mA each) can be connected in parallel to the BF375P as shown below. Depending on the power requirements of the retainers used, it may be possible to connect more than five retainers (refer to the retainer manufacturers instructions for current draw details and bear in mind the BF375P has a maximum output load of 250mA).

For larger systems with multiple BF375Ps, please refer to 'Using Multiple B375Ps' section on page 4.

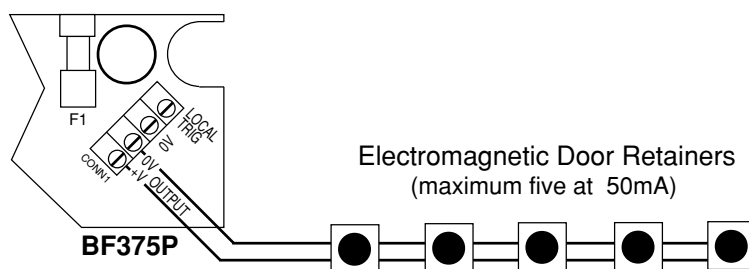

Comsec Protection Systems.

CONNECTING THE INPUTS / TYPICAL WIRING CONFIGURATIONS

Four control inputs are provided on the BF375P, all of which are non-latching. When the correct trigger stimulus is applied to one or more of these inputs, power to the retainer(s) is dropped causing the door(s) to close. The actual input(s) used will depend upon the application. Explanations of all four inputs are shown below together with typical wiring configuration diagrams and system schematics.

Trigger Release Input:

This input requires a signal voltage of 5-27V d.c @ 5mA to trigger. It is usually connected to a suitable control panel 'Fire' relay output. When the signal voltage is applied (i.e. in a fire condition) the doors are released. When the fire condition is reset, power to the retainers is switched back on provided no other trigger stimulus is present. Always ensure a true 'Fire' relay output is used - it SHOULD NOT be possible to hold the doors open in a SILENCED fire condition (i.e. do not connect to a polarised fire alarm sounder circuit).

Connection of Trigger Input to the Relay Output of a Fire Alarm Control Panel

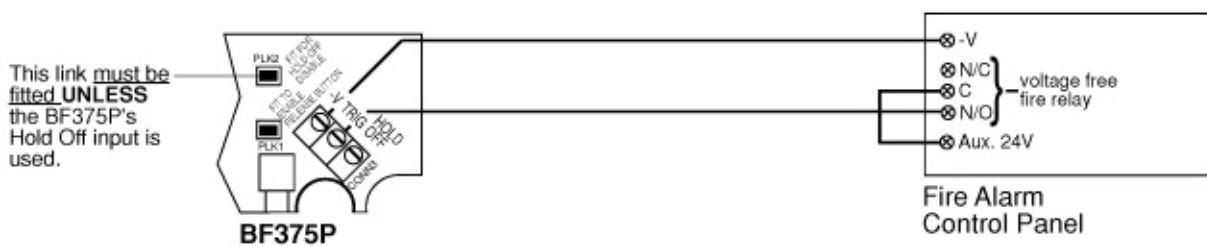

Hold Off Input:

This input requires a signal voltage of 5-27V d.c @ 5mA to be normally present, providing a failsafe link between the BF375P and the control equipment. When the hold off voltage is removed (i.e. in a fire condition or as a result of cable failure), the door(s) are released. When the hold-off signal is re-applied, power to the retainer(s) is switched back on provided no other trigger stimulus is present. Please note: by default, the BF375P's hold off feature is disabled. To enable hold off, ensure selector link PLK2 is not fitted.

Connection of Hold Off Input to the Relay Output of a Fire Alarm Control Panel

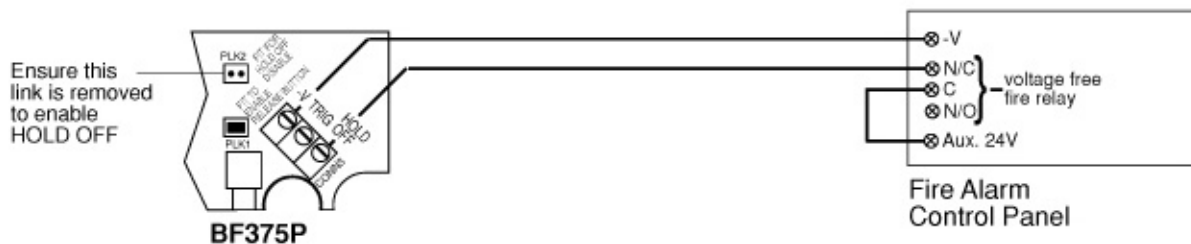

Comsec Protection Systems.

Local Trigger Input:

When this input is taken to 0V, the door(s) are released. It can be connected to any device with voltage-free switch contacts including timers, test switches, open collector outputs, relays, etc.

When the contacts are closed, the door(s) are released. When the contacts are re-opened, power to the retainer(s) is switched back on provided no other trigger stimulus is present.

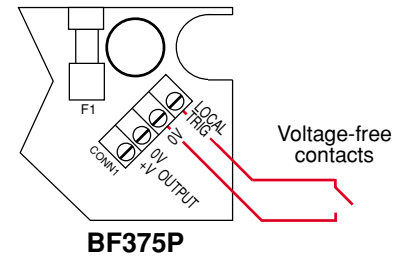

Manual Test Release Button:

Pressing and holding the Manual Test Release Button (located on the PSU's front) overrides all controlling devices to close the door(s).

Releasing the button re-applies power to the retainer(s) provided no other trigger stimulus is present.

To prevent nuisance activation, this feature can be disabled by

removing selector link PLK1 located on the BF375P's pcb (see diagram above right). Please note: The factory default is Manual Test Release Button enabled (link fitted).

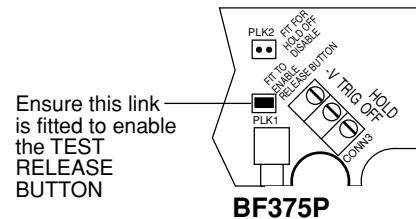

USING MULTIPLE BF375Ps

Multiple BF375P's can be connected to one control panel.

The obvious method is to connect them in parallel. However, this can affect the stand-by time of the control equipment, especially if the BF375P's 'holdoff' feature is used as this draws current continuously.

An alternative method (shown right) is to connect the inputs in series which considerably reduces the amount of current drawn.

Up to four BF375Ps can be connected in this way PROVIDED the minimum hold off voltage expected across all the inputs together is greater than 20V.

This method can also be implemented for BF375P's using the Trigger Release (Trig) Input. However, it cannot be used for units utilising the local trigger input.

It should be noted that the Manual Test Release Button feature remains local to each BF375P.

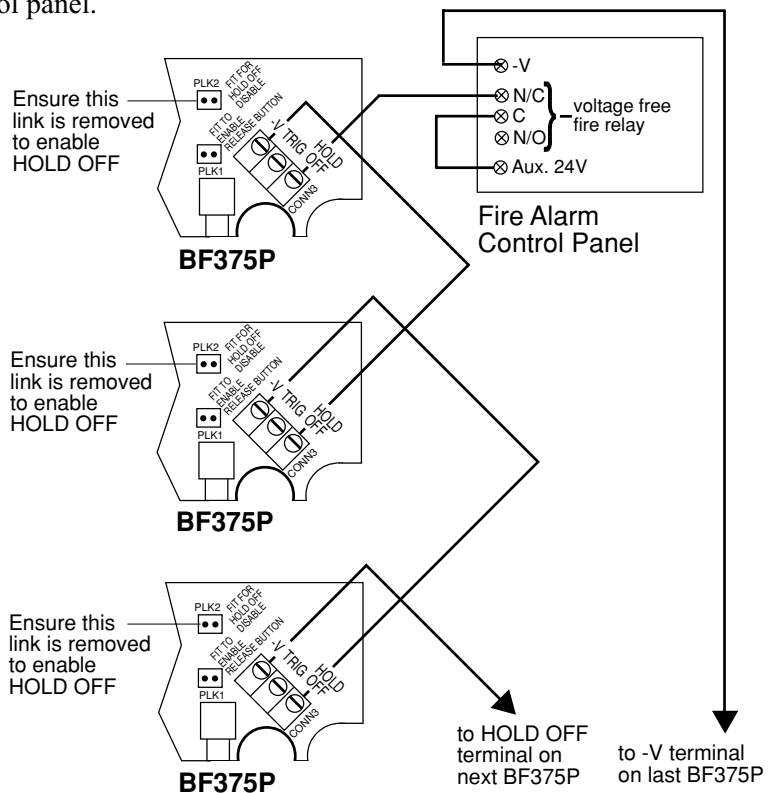

TECHNICAL SPECIFICATION

- **Supply In:** 230Va.c. – 10% @50/60 Hz. ■ **Max Current:** 45 mA. ■ **Supply Out:** 21-28V d.c. ; 250mA.
- **Max No. of Retainers:** 5 rated @ †50mA each. ■ **Physical Size:** 147mm W x 87mm H x 39mm D.
- **Protrusion depth into back box:** 24mm. ■ **Weight:** 480g.

No responsibility can be accepted by the manufacturers or distributors of this product for any misinterpretation of an instruction or guidance note or for the compliance of the system as a whole. These instructions are general and cannot be considered to cover every aspect of an installation. The manufacturers policy is one of continuous improvement and we reserve the right to make changes to product specifications at our discretion and without prior notice. E&OE