

MEGAWISE

USER INSTRUCTIONS



12-speed Hand Blender

MEGAWISE

For your safety and continued enjoyment of this product,
always read the instruction book carefully before using.

MEGAWISE

ACTIVATE YOUR 5-YEAR WARRANTY & EXCLUSIVE GIFT

Register within 7 days after receiving your new product.

Make sure you do this **NOW** to ensure your purchase is 100% covered.

All we need is your name, email and purchase details... that's it!

It **literally** takes only **2 minutes**

REGISTER ONLINE NOW!

→ <http://megawise.com/warranty/>



Our customer service team is standing by so if you have any questions or concerns



→ m.me/MegaWiseUSA

📱 Scan QR Code & Start Chatting



 m.me/MegaWiseUSA

 support@megawise.com

 megawise.com

Your safety and the safety of others are very important.

We have provided many important safety messages in this manual and on your appliance. Always read and obey all safety messages.



This is the safety alert symbol.

This symbol alerts you to potential hazards that can kill or hurt you and others.

All safety messages will follow the safety alert symbol and either the word "DANGER" or "WARNING." These words mean:



Death or serious injury may occur if these instructions are not immediately followed.



Death or serious injury may occur if these instructions are not followed.

All safety messages will tell you what the potential hazard is, tell you how to reduce the chance of injury, and tell you what can happen if the instructions are not followed.

CONTENTS

HAND BLENDER SAFETY.....2

Important Safeguards2

Electrical Requirements.....3

UNPACKING INSTRUCTIONS.....4

PARTS AND FEATURES.....4

ASSEMBLY.....7

Blending Attachment.....7

Chopper/Grinder Attachment.....8

Whisk Attachment.....8

USING THE MILK FROTHER9

Reversible Blade.....10

OPERATION.....10

Blending.....10

Chopping Food.....10

Whisking.....11

CLEANING AND MAINTENANCE.....11

Hand Blender.....11

Chopper/Grinder Attachment.....11

Whisk Attachment.....12

TIPS AND HINTS.....12

For Hand Blender.....12

For Whisk Attachment.....13

For Chopper/Grinder Attachment.....13

FREQUENT USES FOR FOOD PROCESSOR ATTACHMENTS.....14

HAND BLENDER SAFETY

IMPORTANT SAFEGUARDS

When using an electrical appliance, basic safety precautions should always be followed, including the following:

1. READ ALL INSTRUCTIONS CAREFULLY.

2. Unplug the blender from the outlet when not in use, when performing maintenance and before cleaning. To unplug, grasp the plug and remove from the electrical outlet. Never pull the cord.
3. To protect against electrical shock, do not put the motor body, cord or electrical plug of this hand blender in water or other liquids. Only the detachable blending shaft and other certain parts of this appliance have been designed for immersion into water or other liquids. Never submerge any other portion of this unit. If the hand blender falls into liquid, remove it immediately. Do not reach into the liquid without unplugging the unit first.
4. This appliance should not be used by children. To avoid possible accidental injury, close supervision is necessary when any appliance is used by or near children.
5. Avoid contact with moving parts.
6. During operation keep hands, hair and clothing, as well as spatulas and other utensils away from attachments and any mixing containers to reduce risk of injury to persons and/or damage to the appliance. A spatula may be used, but must only be used when the unit is not operating.
7. Do not operate any appliance with a damaged cord or plug, or after the appliance has malfunctioned or has been dropped or damaged in any way or is not operating properly.
8. Remove the detachable shaft from the blender before washing the blades or shaft.
9. Blades are SHARP. Handle carefully when removing, inserting or cleaning. Exercise the same care when removing or inserting the cutting blade disc for the food processor attachment.
10. When mixing liquids, especially hot liquids, use a tall container or make small quantities at a time to reduce spillage, splattering and possibility of injury from burning.
11. To reduce the risk of injury, never place the chopper/grinder attachment cutting blade on a base without first putting the work bowl properly in place.
12. Be certain the food processor attachment cover is securely locked in place before operating the appliance. Do not attempt to remove cover until the blade has stopped rotating.

-
13. Check the work bowl for presence of foreign objects before using.
 14. The use of attachments or accessories not recommended by MegaWise may cause fire, electrical shock or risk of injury.
 15. Do not use outdoors or for other than its intended use.
 16. Do not let any cord hang over the edge of the table or counter. Do not let the cord contact hot surfaces, including stovetops.
 17. Make sure the appliance is off, the motor has stopped completely, and the appliance is unplugged from the outlet before putting on or taking off attachments, and before cleaning.
 18. Do not operate this appliance in an appliance garage or under a wall cabinet. When storing in an appliance garage, always unplug the unit from the electrical outlet. Not doing so could create a risk of fire.
 19. The use of attachments or accessories not recommended by MegaWise may cause fire, electrical shock or risk of injury.

SAVE THESE INSTRUCTIONS. FOR HOUSEHOLD USE ONLY.

ELECTRICAL REQUIREMENTS

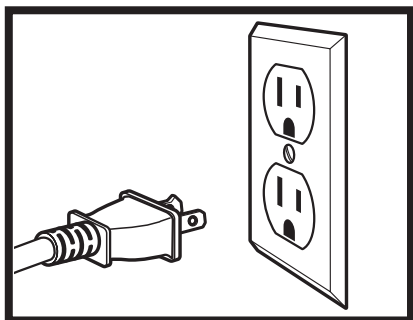

Model No: HB-2046

Volts: 110-120 V

Hertz: 50/60 Hz

Watts: 800W

NOTE:

To reduce the risk of electrical shock, this plug will fit in an outlet only one way. If the plug does not fit in the outlet, reverse the plug. If it still does not fit, contact a qualified electrician. Do not modify the plug in any way.

NOTE:

Always be sure to unplug the power cord from the wall socket before attaching or removing attachments.

UNPACKING INSTRUCTIONS

Place the package containing the 12-speed Hand Blender on a sturdy surface. Unpack the Hand Blender from its box. Gently slide the unit from the box. Remove all support materials from the box. Save packaging for possible repacking of the unit.

NOTE: The blending blade is extremely sharp.

Before using the 12-speed Hand Blender for the first time, we recommend that you wipe the unit with a clean, damp cloth to remove any dirt or dust. Dry it thoroughly with a soft absorbent cloth.

PARTS AND FEATURES

1. Comfort Grip Handle (A)

The handle allows you to control the hand blender with ease.

2. Low/Turbo Two-speed Power Button (B)

Allows you to activate the hand blender at the touch of a button. Simply press and hold down the Low or Turbo button to blend or pulse. Once the button is released, blending will stop.

3. Main Body Housing (C)

The main body is not dishwasher safe.

4. Detachable Blending Shaft (D)

Hold the blending shaft with the blades down, and align the top end of the blending shaft with the corresponding end of the main body and push until the blending shaft 'clicks' and locks into the main body. By pressing the release button on the side of the unit, the shaft will detach for easy cleaning.

5. Blade Guard (E)

The fixed stainless blade is partially covered by a stainless housing that keeps splashing to a minimum. Blades are SHARP. Handle carefully when removing, inserting or cleaning.

6. Whisk Attachment (F)

The whisk attachment snaps into the main body housing.

This attachment is great for whipping cream, egg whites and other delectable treats.

7. Detachable Whisk Gear (G)

The whisk attachment attaches to the whisk gear. The whisk gear is not

dishwasher safe.

8. Chopping Bowl Cover (H)

Align the main body with the chopping bowl lid and push down until the main body 'clicks' into place. Ensure the chopping bowl lid is dry with no water remaining inside before re-attaching. The chopping bowl cover is not dishwasher safe.

9. Chopping Bowl Attachment (I)

Use the chopping attachment to chop small amounts of food such as cooked meat, cheese, vegetables, herbs, crackers and bread. The chopper bowl attachment is dishwasher safe.

10. Reversible Blade (J)

Place the reversible chopping blade onto the metal pivot pin in the base of the chopping bowl. Blades are SHARP. Handle carefully when removing, inserting or cleaning.

11. Mixing Cup/Beaker (K)

The 600ml mixing cup/beaker is dishwasher safe. Use this container to blend drinks, shakes, salad dressings and more.

PARTS AND FEATURES

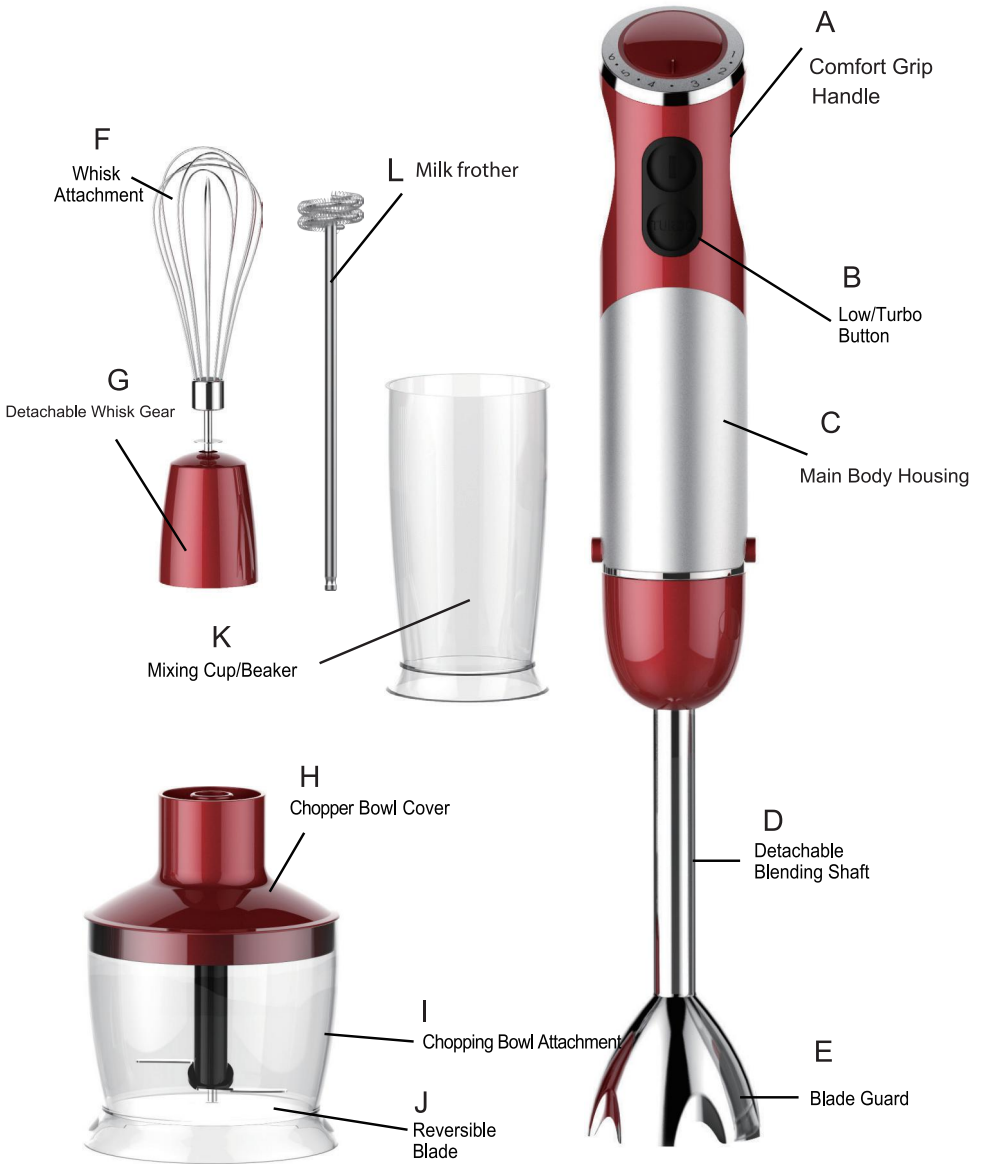

ASSEMBLY

BLENDING ATTACHMENT

1. Align the main body with the blending shaft and push the pieces together until you hear and feel them click together. It may be helpful to press the release button when assembling.

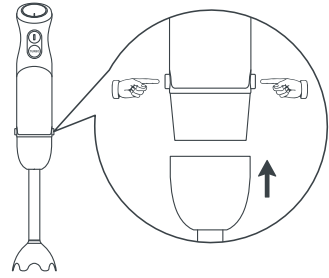

2. Plug the power cord of the hand blender into an electrical outlet.

NOTE: The motor body is not dishwasher safe

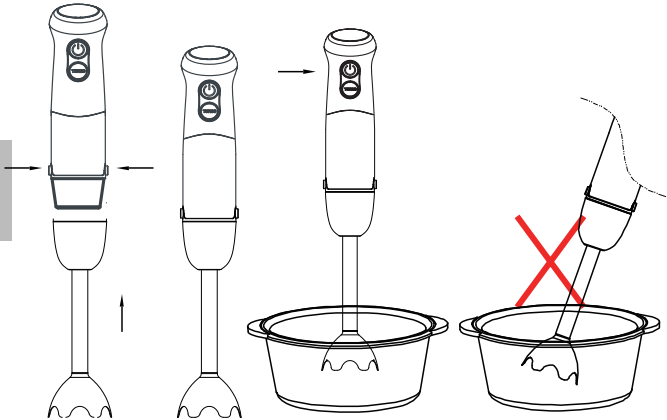

NOTE: Do not immerse the motor body or the adapter in water.

CHOPPER/GRINDER ATTACHMENT

1. Connect the main body to the top of the work bowl cover.
2. Align the food processor cover's drive shaft with the ribbed opening on the underside of the main body.
3. When aligned properly, slide the two pieces together until you feel and hear a slight click.

! WARNING

Cut Hazard

Handle blades carefully.

Failure to do so can result in cuts.

CHOPPER/GRINDER ATTACHMENT

NOTE:

The chopper bowl cover is not dishwasher safe

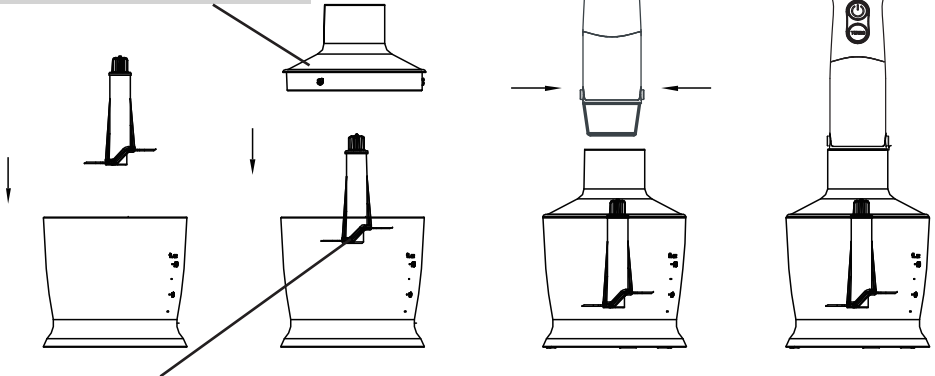

NOTE: Do not lift the blade before the chopping operation has completely finished.

1. Place the chopping/grinding blade into the center of the work bowl over the metal blade shaft.
2. Place the main body housing cover on top of the work bowl and rotate counterclockwise to lock into place.
3. Plug the power cord of the hand blender into an electrical outlet.

WHISK ATTACHMENT

1. Align the main body with the assembled whisk attachment and push the pieces together until you hear and feel them click together. It may be helpful to press the release button when assembling.

NOTE:

The whisk gear is not dishwasher safe.

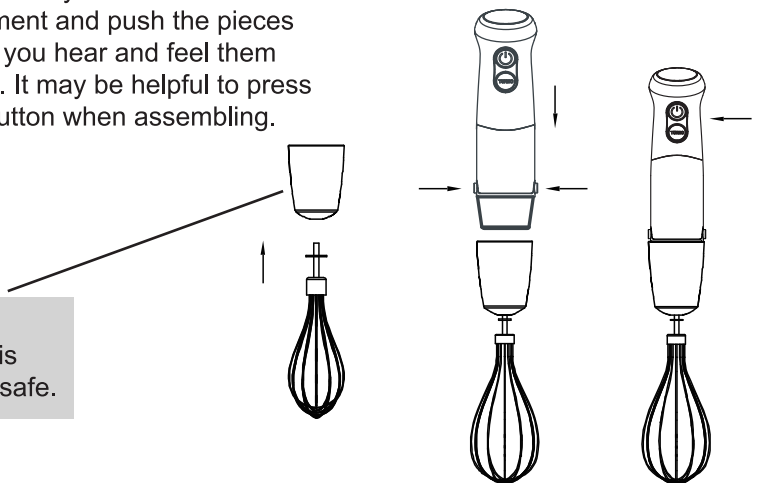

USING THE MILK FROTHER

1. Align the main body with the assembled milk frother attachment and push the pieces together until you hear them click together. It may be helpful to press the release button when assembling

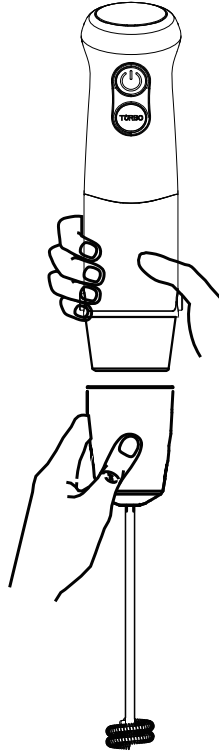

2. To prevent ingredients splashing, firstly use the hand blender on setting **START** for approx 30 seconds, before switching to **TURBO**.

REVERSIBLE BLADE ASSEMBLE THE PARTS

1. Place the work bowl on a flat, dry, stable surface. It should be close to an electrical outlet of 110-120V.
2. The metal blade assembly shaft (A) is attached to the bottom of the work bowl. If not already in place, slide the fully assembled blade assembly (B) over the top of the metal blade assembly shaft.



OPERATION

BLENDING

The specially designed blade is for mixing and puréeing all kinds of foods, including salad dressings, powdered drink products, soups, sauces and blended drinks like milkshakes.

This blade mixes and stirs while adding only a minimum of air to your mixture. A gentle up-and-down motion is all you need to make the most flavorful, full-bodied recipes. Be careful never to remove the blending shaft from the liquid while in operation, for it will splatter. Tilt the pan or bowl away from you if needed to ensure the protective blade guard on the blending shaft is fully submerged.

1. Put the blending shaft into the mixture to be blended.
2. Press and hold the desired speed button. The hand blender will continue to run as long as the button is pressed in. To turn the hand blender off, release the power button and the motor will stop.
3. Unplug immediately after use. Caution: Do not put fingers near blade. To dislodge food, unplug the hand blender from the outlet first.
4. Do not use in non-stick cookware to avoid scratching.

CHOPPING FOOD

1. Place the work bowl firmly on a flat, sturdy surface like a countertop.
2. Put food in the work bowl. Be sure the food is cut into small pieces ($\frac{1}{2}$ to 1 inch), and the bowl is not overloaded.

⚠ WARNING
Do not operate the blender for longer than 60 seconds at a time. Failure to do so can result in overheating.

4. Press and hold the desired speed button.

Note: Due to the powerful motor provided with this unit, recommends using one hand to support the work bowl during operation .

5. When you have finished processing the food, stop the blender by taking your finger off the desired speed button.

6. WHEN THE BLADE STOPS MOVING, unplug the unit.

7. Remove the main body with the cover from the work bowl.

8. Carefully remove the chopping blade. NEVER TOUCH THE BLADE ITSELF.

9. Remove food with a spatula.

Note: Do not operate the chopper/grinder attachment without food contents in the work bowl.

10. Do not use the chopping bowl or the beaker in a microwave oven.

WHISKING

1. Insert the whisk attachment into the main body.

2. Plug the electrical cord into a wall socket.

3. Put the whisk into the mixture that is to be blended.

4. Press and hold the desired speed button. The hand blender will continue to run as long as the switch is pressed. To turn the hand blender off, release the power button and the motor will stop.

CLEANING AND MAINTENANCE

HAND BLENDER

Always clean the main body and blending shaft thoroughly after using. Remove the blending shaft from the main body. Clean the main body only with a sponge or damp cloth. Do not use abrasive cleaners that could scratch the surface. To clean the blending shaft, wash by hand in hot water using mild detergent. Be mindful of the fixed razor-sharp edges.

CHOPPER/GRINDER ATTACHMENT

To simplify cleaning, rinse the work bowl, blade and cover immediately after use so that food won't dry on them. Do not submerge the work bowl cover in water or put in the dishwasher. Wash the chopping blade and work bowl in warm, soapy water. Rinse and dry. Wipe the underside of the cover with a sponge or damp cloth to remove any food. Wash the blade carefully. Avoid leaving it in soapy water where it may remain unseen.

You can wash the work bowl and chopping blade, on the upper shelf of your dishwasher. Unload the dishwasher carefully to avoid contact with the sharp blade. Wipe the motor body and top of the cover with a damp sponge or cloth. Dry it immediately. Never submerge the motor body or the cover in water or other liquids. The food processor attachment is intended for HOUSEHOLD USE ONLY.

WHISK ATTACHMENT

To clean your whisk attachment, simply release the attachment from the motor body housing. Once the whisk is removed, detach the metal whisk from the gear by pulling the two pieces apart. To clean the gear, simply wipe with a damp cloth. To clean the metal whisk, wash with warm soapy water or put into the dishwasher. Do not submerge the gearbox in water or any other liquid. Any service, other than cleaning and normal user maintenance, should be performed by an authorized MegaWise Service

TIPS AND HINTS

FOR HAND BLENDER

- Be sure that the blending blade guard is fully submerged before blending ingredients.
- To purée a soup, use the hand blender to blend the soup ingredients to the desired consistency, using a gentle up-and-down motion directly in the saucepan or pot.
- When blending ingredients directly in a pot or pan, tilt the pan away from you to create a deeper area for blending to prevent splatter.
- Do not use in non-stick cookware, be careful not to scratch the coating with the hand blender.
- When blending into the blending cup, for example when making a fruit smoothie, cut most solid foods into ½ inch pieces for easy blending.
- Use the hand blender to make smooth gravies and pan sauces.
- Do not immerse the main body of the blender in water or any other liquid.
- When blending in the mixing cup, pour liquid ingredients in first, unless recipe instructs otherwise.
- Do not attempt to blend/mix ice cubes, bones, coffee beans or other hard materials, as these are liable to damage the blades.

-
- To avoid splashing, insert the hand blender into the mixture before pressing the power button, and release the power button before pulling the hand blender out of the mixture.
 - Do not overfill the mixing containers. The level of the mixture will rise when blending and can overflow.
 - To whip air into a mixture, always hold the blade just under the surface.
 - Using a gentle up-and-down motion is the best way to blend and incorporate ingredients uniformly.
 - Liquid should not come closer than 1-inch of where the shaft attaches to the main body.

FOR WHISK ATTACHMENT

- Do not immerse whisk attachment gear in water or any other liquid.
- Use the whisk attachment for beating heavy cream or egg whites.
- When beating egg whites use a very clean metal or glass bowl, never plastic. Plastic can contain hidden oils and fats that can ruin the delicate egg white foam. To help stabilize the egg whites, add 1/8 teaspoon of cream of tartar per egg white prior to beating them. (If using a copper bowl omit the cream of tartar.) Beat the egg whites until desired peaks form.
- It may also be used for any task that you would normally whisk by hand, like crêpe batters or eggs for omelets.
- Beating the egg whites too long causes them to dry out and become less stable.
- When adding sugar to beaten egg whites, add it slowly when soft peaks just begin to form and then continue beating to form desired peaks.
- When beating heavy cream, if possible and time allows, use a chilled bowl and chill the whisk attachment. The best shaped bowl for whipping cream is one that is deep with a rounded bottom to minimize any splatter.
- The cream should come out of the refrigerator just before whipping. Whipped cream may be used at either soft or firm peaks depending on preference. It may be flavored as desired. For best results, whip cream just before using.

FOR FOOD CHOPPER/GRINDER ATTACHMENT

- When making compound butters, remove the butter from the refrigerator and let it come to room temperature before blending the ingredients.
- Do not use the chopping bowl or the beaker in a microwave oven.

- Some spices may scratch the work bowl.
- Liquids in the work bowl should not exceed 1½ cups.
- Do not overload the work bowl. For best results most foods should not reach more than 2/3 of the way up the work bowl.
- Do not attempt to chop Ice cubes, bones, coffee beans or other hard materials, as these are liable to damage the blades.
- Do not immerse the food processor cover in water or any other liquid.
- Do not operate chopper/grinder attachment for more than 30 seconds continuously.
- The size of pieces you put in the bowl should be about the same size to achieve even results.
- For raw ingredients: peel, core and/or remove seeds and pits. Food should be between ½ and 1-inch, depending on hardness of the food.
- Pulse food in 1-second increments to chop. For the finest chop, process continuously. Watch ingredients closely to achieve desired consistency and scrape the work bowl as necessary.



FREQUENT USES FOR CHOPPER/GRINDER

Ingredient	Speed	Comments
Baby foods (always consult a pediatrician or family physician for appropriate food recommendations)	Low-Turbo	Place small amounts of cooked foods into chopping/grinding bowl. Add a small amount of appropriate liquid. Pulse to chop, then hold to blend.
Bread crumbs - fresh or dry (day old)	Turbo	Pulse to chop, then process until desired consistency is reached.
Hard cheese (Asiago, Locatelli, Parmesan, Romano, etc.) (Not recommended for softer cheeses unless making a dip or dressing)	Turbo	Cut into 1/4-inch pieces. Pulse to chop, then process until desired consistency is reached.
Chocolate	Turbo	Cut into 1/2 inch pieces; may chill in freezer for 3 minutes before chopping. Pulse to chop, then process, no more than 1 ounce at a time, until desired texture is reached.

Creamy Dressing and Dips	Low	Place ingredients in chopping/grinding bowl; do not cover or spill. Use a pulse action to chop, then continuous-hold action to blend to desired consistency.
Garlic	Turbo	Peel up to 6 cloves. Pulse to chop.
Gingerroot (fresh)	Turbo	Peel, cut into-1/2 inch pieces. Pulse to chop 1/2 ounce at a time.
Hard spices (coriander, dill, poppy, star, anise, etc.)	Turbo	Pulse to chop until desired consistency. Pulse with sharp blade to get fine results.
Herbs (fresh)	Turbo	1/2 cup; must be clean/dry. Pulse to chop.
Nuts	Turbo	Shelled; toast first for best flavor. Pulse to chop, process up to a 1/3 cup at a time, until desired consistency is reached. May be processed to nut-butter stage.
Onion	Turbo	Peel, cut into 1/2-inch pieces. Pulse to chop up to 1/2 cup at a time, until desired chop is reached.
Vegetables (cooked)	Low-Turbo	Cut into inch pieces; pulse to chop, up to 1/2 cup at a time. Add cooking liquid, stock or milk to process to a puree. It is not recommended for making mashed potatoes.
Vegetables (uncooked)	Turbo	Peel as needed; cut into 1/2-inch pieces. Peel celery with peeler to remove tough outer layer. Chop/process up to 1/2 cup at a time.
Meat (Beef, Pork)	Turbo	6 oz. or 175g, cut into 1/2 inch pieces. Pulse until desired consistency.
Simple Blending	Low-Turbo	For light mixing and incorporating.
Cream (for whipping)	Turbo	1/4 cup. Whisk until desired consistency.
Egg whites (for whipping)	Turbo	2 to 3 egg whites. Process until desired consistency.

- Actual usage may vary depending on quality of food and desired chop size.
- When mixing dry, thick or heavy mixtures, allow the motor to rest for 1 minute between each use.

MEGAWISE

 m.me/MegaWiseUSA
 support@megawise.com
 megawise.com

Made in China



This device complies with Part 15 of the FCC Rules. Operation is subject to the following two conditions:
(1) this device may not cause harmful interference, and (2) this device must accept any interference received, including interference that may cause undesired operation.