

RX1200L



RX1200L with end caps removed for rack mounting -or- RX1200R

CONGRATULATIONS on your purchase of Carvin's **RX1200L** or **RX1200R** mixer. The **RX1200L** includes built-in high power amplifiers for direct hook-up to your speakers, while the **RX1200R** is a non-powered model designed for use with your own power amps. Please read this manual carefully to take advantage of the many features of your mixer.

SUPERB SOUND is derived from the extremely low distortion, "high headroom" design. State-of-the art, low noise, balanced XLR preamps from our Concert Series mixers provide a common mode rejection better than 78 dB, which means that any noise that may come over your cables is virtually eliminated. Even the balanced XLR output connectors guard your system from cable noise for professional recordings or external power amp connections. Distortion is nearly non-existent with THD below .1%, which guarantees the purity of your sound. Hear the difference.

LIGHT WEIGHT and EASY TO USE Controls are logically laid out, making the RX Series simple to use reducing errors during setup and performance. Its compact size and weight of 18 lbs. makes it the lightest, most powerful mixer in it's class.

4 HIGH CURRENT CLASS-D AMPLIFIERS produce total of 1600 watts RMS. Class-D amps not only run cooler, but their power capabilities are outstanding. 800 watts RMS (400w/400) for your main L and R speakers, plus 800 watts RMS (400w/400) to power your stage monitors - this is the kind of output power that maintains the purity and integrity of your sound. Speaker outputs accept either standard 1/4" or Speakon™ connectors for secure connections with maximum power transfer to your speakers. Clip LEDs give you a visual indicator for each amp.

HIGH CURRENT SWITCHMODE POWER SUPPLY conserves power by operating at higher efficiency. The DC voltage supply is recharged 100,000 times per second, delivering continuous high current to the power amps.

The **RX1200L** and **RX1200R** will auto-switch for 120VAC or 240VAC. Like a laptop computer, you can go anywhere in the world and not worry about power converters.

2 INDEPENDENT 24-Bit STEREO DSP EFFECTS allow you to independently assign each channel to your choice of simultaneous effects. You can dedicate chorus/reverb to the acoustic guitar channel and reverb to the vocals, etc. Both effects are assignable to your stage monitors so you can hear yourself with full effects. The effects processors feature 256 effects each, including reverbs, choruses, flanging and echoes, with parameters fully adjustable for; damping, decay, depth, speed, regeneration and time.

ACTIVE 3 BAND CHANNEL EQ provides easy adjustment for the tone you want. The 80 Hz LO frequency control deliver solid non-flabby bass. A simple adjustment with the MID control gives you the best sound for vocals or guitar by affecting the very important 750Hz frequency range. The 11.5k Hz HI treble control adds sparkle to your top-end without adding harshness. Both the LO and HI are "shelving", which means they are effective from 20Hz up to 20kHz.

FOUR 7 BAND EQUALIZERS provide precise adjustments to fine tune your overall sound and to help control feedback. Unlike one stereo graphic equalizer, four independent 7 bands give you total control over each power amp.

BUILT-IN AMP LIMITERS The purpose of a limiter is to hold down peaks so the amp won't distort even with extra hot input signals (this protects your expensive speakers). Limiters can increase your amp's average output by 3 db or more, while keeping your sound clean and uncolored.

ENGINEERED TO LAST Every RX Series mixer is housed in a rugged steel rackmountable chassis. Continuous full power is assured from high-grade 6063-T5-aluminum heat sinks cooled

by a variable speed fan. Sealed controls and switches guard against the outside elements while heavy-duty connectors provide a positive connection to your cables. Hidden deep in the heart of these mixers is the "SMT" Surface Mount Technology that utilizes surface mounted components to prevent parts from shaking or vibrating loose. Precision 1% tolerances guarantee that your settings will be accurate every time. Fire retardant FR-4 military spec circuit boards feature double-sided copper construction to guard against noise and radio frequencies (RF). The RX Series is made in the USA.

RECEIVING INSPECTION—read before getting started

INSPECT YOUR AMP FOR DAMAGE which may have occurred during shipping. If damage is found, please notify the shipping company and CARVIN immediately.

SAVE THE CARTON & ALL PACKING MATERIALS. In the event you have to re-ship your unit, always use the original carton and packing material. This will provide the best possible protection during shipment. CARVIN and the shipping company are not liable for any damage caused by improper packing.

SAVE YOUR INVOICE. It will be required for warranty service if needed in the future. SHIPMENT SHORTAGE. If you find items missing, they may have been shipped separately. Please allow several days for the rest of your order to arrive before inquiring.

RECORD THE SERIAL NUMBER on the enclosed warranty card or below on this manual for your records. Keep your portion of the card and return the portion with your name and comments to us.

USA customers register online at: www.carvin.com/registration

All other countries register online at: www.carvinworld.com/registration

for your records, you may wish to record the following information.

Serial No. _____ Invoice Date _____

MODEL RX1200L, RX1200R SPECIFICATIONS:

- Frequency Response:** Mic or Line Inputs: 20Hz-20kHz ±1dB
- Total Harmonic Distortion:** Less than .1% at nominal levels
- Equivalent Input Noise:** 150 ohm source: -117dBu
- Output Noise:** -100dBu Master Line Out (All Levels Minimum)
- Output Headroom:** +10dB
- Maximum Gain:** Mic in to Master Line Out: 60dB
- Crosstalk:** Adjacent ch's: -60db at 1KHz
- Common Mode Rejection:** -78db at 1KHz
- Phantom Power:** 48 volt @ XLR Mic channels
- Channel EQ 3-band active:** LOW: 80Hz ±12dB
MID: 750Hz ±12dB
HI: 11.5KHz ±12dB
- Power Output:** **RX1200L:** 1600w @ 4 ohms (8 ohm: 250w x4, 4 ohm: 400w x4)
RX1200L (w/ sides): 10.25"H x 19"W x 9.5"D, 18 lbs.
RX1200L (no sides): 8.75"H x 19"W x 8"D, 14.5 lbs.
in RW5 RoadWarrior 5U case: 11"H x 21.5"W x 15.5"D, 36 lbs.
RX1200R: 8.75"H x 19"W x 8"D, 10.5 lbs.
- Size and Weight:**
- Power Requirements:** **RX1200L: USA model:** 100-140VAC 60Hz
RX1200R: USA model: 100-140VAC 60Hz
RX1200L-E: EU model: 200-250VAC 50Hz
RX1200R-E: EU model: 200-250VAC 50Hz
- Options:** **USM16-MC or USM16-BP wireless systems (require USM16-KIT)**
FS22 footswitch for Effects bypass
RW5 Road Warrior 5U case
RW6 Road Warrior 6U case for use with USM16 option



12340 World Trade Drive, San Diego, CA 92128
www.carvin.com

RX1200L, RX1200R CONTROLS

QUICK START UP

If you're like most new owners, you're probably in a hurry to plug your mixer in and use it. Here are some brief instructions to get you going quickly. With the mixer unplugged and the unit turned off, complete the following procedures:

A. CONNECTING AC POWER TO YOUR MIXER

- Be sure to plug your mixer into the proper voltage for your country. The **RX1200L** and **RX1200R** is available in either **120V** or **240V** models.
- Use only a grounded (3 prong) power outlet to prevent a shock hazard. This gives the quietest grounding for your mixer.

B. CONNECTING INPUTS TO YOUR MIXER

- For balanced microphones, use a shielded cable and plug into the XLR MIC inputs.
- For high output devices like instruments & keyboards, plug into the LINE input jacks using a shielded cable. Be sure the LINE/INS switch is in the "OUT" position.

C. TURNING YOUR MIXER ON

- Set all channel and master LEVEL controls to their OFF positions
- Set all HI, MID, and BASS controls and the graphic equalizers to their center "flat - no boost or cut" position.
- Adjust all channel "PAN" controls to their center position.
- Connect your speakers and monitors at the rear panel.
- Turn the mixer on by the rear POWER SWITCH and watch for the front POWER LED to come on. Your mixer is now ready to operate by turning the levels up.

MIC CHANNEL FEATURES

1. LINE INPUT/INSERT JACKS

The LINE input is a 1/4" phone jack designed for balanced or unbalanced line or instruments. Examples of these inputs would be guitar, keyboard or CD player. The line input can be used at the same time the mic input is being used. For channels 1-6, this jack becomes an insert when the INSERT switch is pushed "IN". (see #2.)

2. INSERT SWITCH

The LINE/INS switch changes the function of the channel's 1/4" jack. The "OUT" position is for normal LINE level inputs. Pressing the switch "IN" changes the jack into an INSERT with SEND and RETURN. This allows you to place effects on the channel after the GAIN control for lowest noise. To insert effects (such as a compressor, etc.) use a 1/4" stereo splitter adapter (like Carvin AP1).

Connections are TIP-SEND and RING-RETURN.

3. XLR MICROPHONE INPUT

The XLR MIC input is designed for balanced low impedance microphone and DIRECT OUT signals. The high performance mic preamps do a superb job of noise reduction, but to get the lowest noise adjust the GAIN control properly (see #5). Note: Make sure the phantom power is switched off before connecting or disconnecting microphones to the mixer.

4. CHANNEL LEVEL CONTROL

The LEVEL control adjusts the volume of the channel before going to the PAN control. Here is where the individual channel volumes are adjusted to make up the overall mix at the MAIN L/R outputs. Start with the LEVEL set between 3-5.

5. GAIN CONTROL / PK LED

The GAIN control varies the input level on both the LINE and MIC input jacks by 40dB. With a LOUD input signal, (loud vocal, hard hits on drums, etc...)

turn up the GAIN control until a strong signal is present. If the "PK" LED shows or distortion is heard, the input stage is being overdriven. Lower the GAIN control until the LED does not light.

6. CHANNEL PAN CONTROL

The PAN control sends the channel signal to the MAIN L/R outputs. If stereo placement is needed, turn the PAN control toward the LEFT or RIGHT position.

7. EFF 1 & EFF 2 CONTROLS

The EFF 1 and EFF 2 controls adjust the levels sent to the dual effects processors and to the EFF 1 and EFF 2 SND jacks. The effects controls are post-channel level and automatically track the channel's LEVEL & tone controls. Reduce these levels if PEAK LEDs are flashing on the effects processors.

8. MON 1 & MON 2 CONTROLS

The MON 1 and MON 2 level controls adjust the volume of the channel going to the monitor amps. The monitor level control is a pre-channel level control. This means it is unaffected by adjustments from the channel level. The purpose for this is the monitor mix adjustments can be made without disturbing the main mix.

9. CHANNEL TONE CONTROLS

Each channel features active 3-band tone controls LO, MID, and HI. These function as boost (clockwise) or cut (counter-clockwise) controls. The center 0 is the "flat" or no effect position. The LO and HI controls are shelving type with corner frequencies at 80Hz and 11.5k Hz

12. MONITOR 1 & MONITOR 2 LEVELS (AMPS 3&4)

The MONITOR 1 and MONITOR 2 levels are sent to the GRAPHIC EQs which feed the AMPS 3 & 4, and the MONITOR 1&2 output jacks.

13. MUSIC BREAK SWITCH

The MUSIC BREAK feature turns off all inputs except for the last channel (ch 12). This is useful during breaks. This allows pre-recorded music to be played through the TAPE IN jacks. The channel 12 MIC, TAPE and LINE inputs are left active for announcements or solo performers. The remaining input channels (1-11) are turned OFF eliminating feedback or other unwanted sounds from open mics during breaks or changes. The internal effects are also muted.

14. TAPE OUT LEVEL

The TAPE OUT level sends the MAIN L/R signal (pre graphic EQ) to the TAPE OUT RCA jacks for recording. If the TAPE OUT is being used to record, make sure the recorder's outputs are not connected to the CH12 TAPE IN jacks, or feedback may occur.

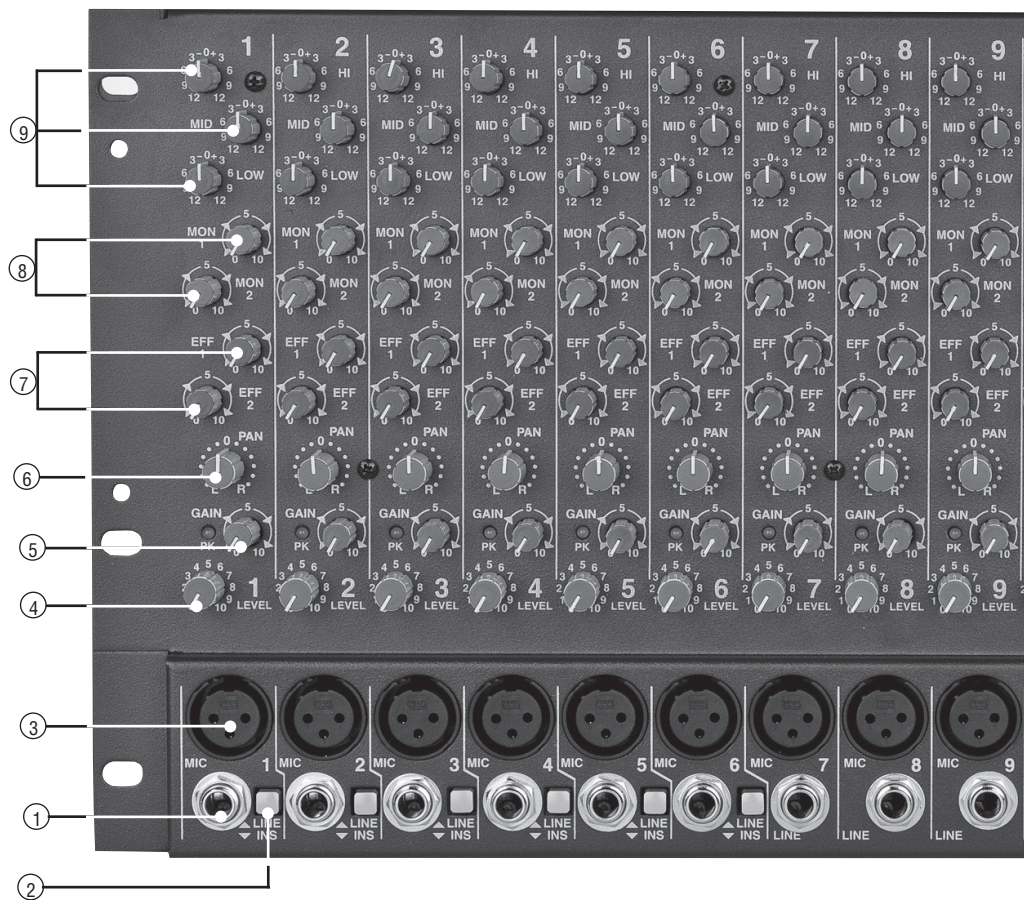

respectively. The MID control is a band pass type centered at 750Hz.

10. LINE/TAPE IN L-R INPUT JACKS (CH 12)

The L-R TAPE IN RCA inputs are ideal for connecting a MP3 or CD player. The L-R LINE 1/4" jacks can be used for a stereo instrument (keyboard, etc.) or for returning from a stereo effects processor. Input level is controlled from the channel 12 LEVEL control.

MASTER SECTION FEATURES

11. MAIN L/R LEVEL (AMPS 1&2)

The MAIN L/R control is the master volume control for all channels. The MAIN L/R signals are sent to GRAPHIC EQs 1&2 that feed the AMPS 1&2, the LEFT and RIGHT XLR output jacks, and the MONO (SUB) output jack.

15. TAPE OUT JACKS

The L-R TAPE OUT RCA jacks send the MAIN L/R signals (pre graphic EQ) for recording. Output level is adjusted at the TAPE OUT control.

16. USB POWER PORT

The USB POWER PORT allows charging of an MP3 player, or to power accessories such as LED lighting. Connect audio from devices to the TAPE L-R inputs on channel 12.

17. LEFT & RIGHT XLR OUTPUTS

The LEFT and RIGHT balanced XLR line outputs are the same signals that feed the internal AMPS 1&2. Use these outputs for additional power amps or recording gear.

18. MONO (SUB) XLR OUTPUT

The MONO (SUB) output combines the MAIN L/R output signals that feed the internal AMPS 1&2. Use this output for additional power amps or amplified subwoofer.

19. SUB X-OVER SWITCH

The **SUB XOVER** (crossover) switch removes all frequencies above 120Hz for connecting the **MONO(SUB)** output to an amplified subwoofer. This is a 3rd order (18db/oct.) filter.

20. PHANTOM POWER SWITCH AND LED

The **PHANTOM PWR** switch turns on the microphone phantom power in the channel XLR jacks. This power is used for supplying a voltage to condenser microphones. The LED indicates the phantom power is turned on. The phantom power will not damage conventional dynamic microphones. Note: Make sure the phantom power is switched off before connecting or disconnecting microphones to the mixer.

21. MONITOR 1&2 OUTPUTS

The **MONITOR 1 - 2** line outputs are the same signals that feed the internal **MONITOR AMPS 3 & 4**. Use these outputs for additional power amps or recording gear.

red **PEAK** LEDs are flashing on the processors.

Turn up the **MAIN** controls to add effects to the **MAIN L/R** **OUTPUTS**.

The **MON 1-2** levels control the amount of effects that go to the **MONITOR** outputs.

EFFECT PARAMETERS

Each of the four effects have variable parameters that are easily adjusted by the **SELECT** and the **PARAMETER** controls to get the desired effect. Each "SELECT" & "PARAMETER" is described below. Note: An audible noise will be heard while adjusting the effects.

A) ECHO: Use **SELECT** to change the amount of regeneration (number of repeats). The **PARAMETER** control adjusts the delay time between the original signal and the echo.

B) REVERB: Turn **SELECT** for the amount of presence (high frequencies) in the reverb. The **PARAMETER** control adjusts decay.

C) CHORUS: Turn **SELECT** for the amount of reverb with your chorus. The **PARAMETER** control adjusts the depth.

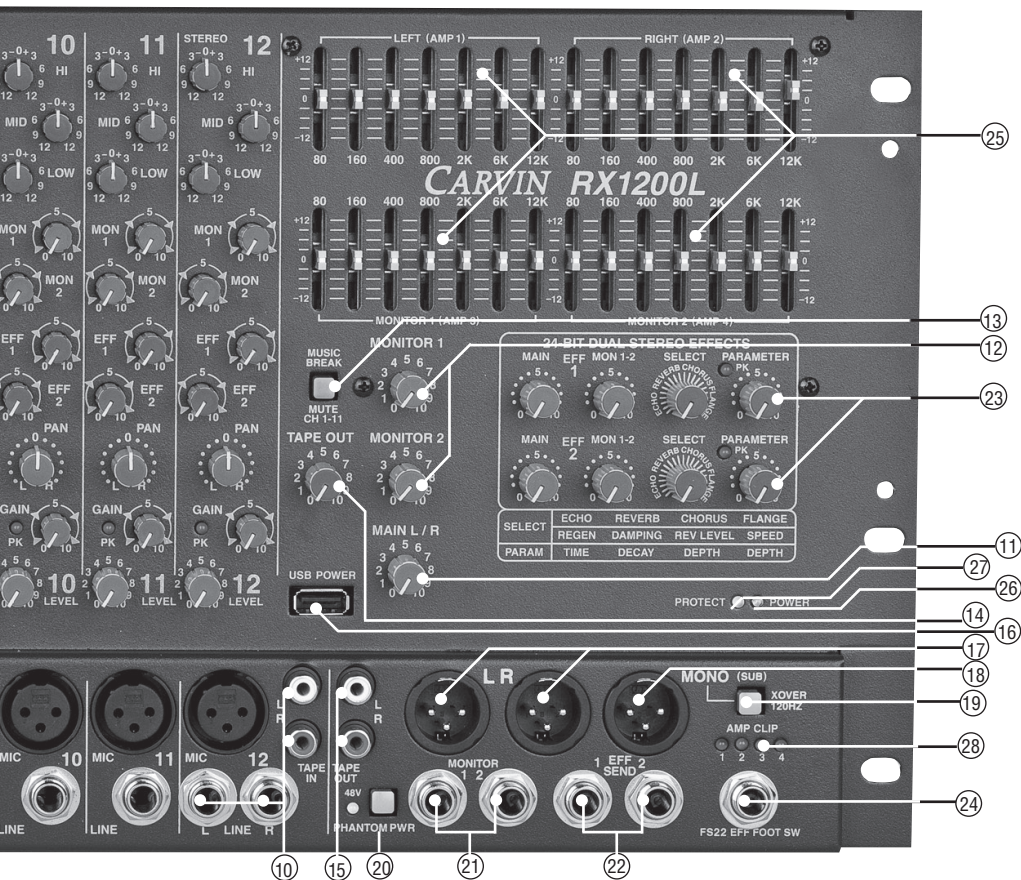

22. EFF SEND 1&2 JACKS

The **EFF SEND 1&2** jacks can send signals to external processors. These are the same signals sent to the internal **EFFECT 1** and **EFFECT 2** processors.

23. DSP EFFECTS PROCESSORS

Two 24-Bit processors provide a host of great sounding effects including Flange, Reverb, Echo, & Chorus.

The channel **EFF 1** & **EFF 2** send controls deliver the signals to the dual processors. Note: Reduce these levels if the



D) FLANGE: Turn **SELECT** for the speed of your flange (phasing effect). The **PARAMETER** control adjusts depth.

24. EFFECTS FOOT SWITCH JACK

The optional **FS22** will remotely shut off **EFFECTS 1** or **EFFECTS 2**.



25. ADJUSTING THE GRAPHIC EQUALIZER

When the **EQ** sliders are in their center position, they do not affect the audio signal. When **EQ** sliders are raised or

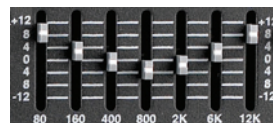

lowered from this position, they boost or cut respectively a narrow frequency band. To reduce feedback in the low frequency range, try lowering one of the 80 or 160 Hz sliders. High frequency feedback is usually reduced by lowering one of the 2k or 6k Hz sliders.

To help prevent feedback, the main speakers should be placed in front and away from the microphones.

For tone enhancement you may want to raise the 80, 160 sliders for deeper bass or the 6k, 12k sliders for crisper highs.

26. POWER LED

The blue **POWER** LED indicates when the mixer is powered on.

27. PROTECT LED

The mixer may go into "PROTECT" mode, engaging relays to mute the speakers if: a) impedance is below 4 ohms on any amplifier, b) shorted speaker cables, or c) ventilation problems. If this LED comes on, shut the mixer **OFF** and check for cable problems, proper impedance and obstructed rear cooling vents. If you encounter an over-heat problem, leave the mixer **ON** allowing the fan to cool down the internal components. The mixer will auto-reset.

28. AMP CLIP LED's

The **AMP CLIP** LEDs indicate when the internal power amps are starting to distort (clip). Reduce the **MAIN L/R**, **MONITOR 1** or **MONITOR 2** master volumes to prevent distortion.

REAR PANEL FEATURES

RX1200L

29. POWER CONNECTIONS

The rear panel contains the **POWER SWITCH** and **AC** power cable connection.

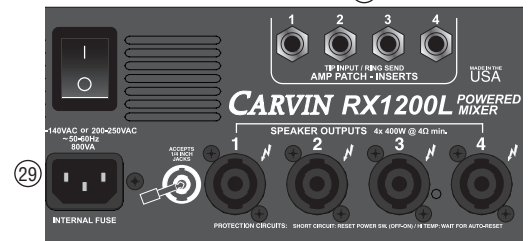

30. AMP PATCH INSERTS

The **AMP PATCH INSERT** jacks offer full flexibility for mixer to amp signal routing.

These jacks are T-R-S (Tip-Ring-Sleeve). Tip is the power amp input. Ring is the signal sent from the mixer. The built-in power amp limiters are post insert.

Patching a compressor or equalizer between the mixer and the amp can be done by using a stereo insert cable (like Carvin's AP1). Connect the **RING** signal to the **INPUT** of the external device, and the **TIP** signal from the **OUTPUT** of the device.

Plugging in a standard 1/4" cable (mono) into the **AMP PATCH INSERT** jacks allows any external signal to be sent to the internal power amps.

DO NOT USE A BALANCED SIGNAL CABLE

31. SPEAKER CONNECTIONS

For the **RX1200L**, there are 4 speaker jacks. These will accept either Twist-Lok (Speakon™) or 1/4" plugs.

AMP 1 is for **LEFT** speakers.

AMP 2 is for **RIGHT** speakers.

AMP 3 is for **MONITOR 1** speakers.

AMP 4 is for **MONITOR 2** speakers.

NOTE: 4 ohms MIN. IMPEDANCE PER AMPLIFIER (Maximum one 4 ohm or two 8 ohm speakers per amp).





RX1200L in RW5 Road Warrior Case
20.5"W x 10"H x 12.75"D (without lids)

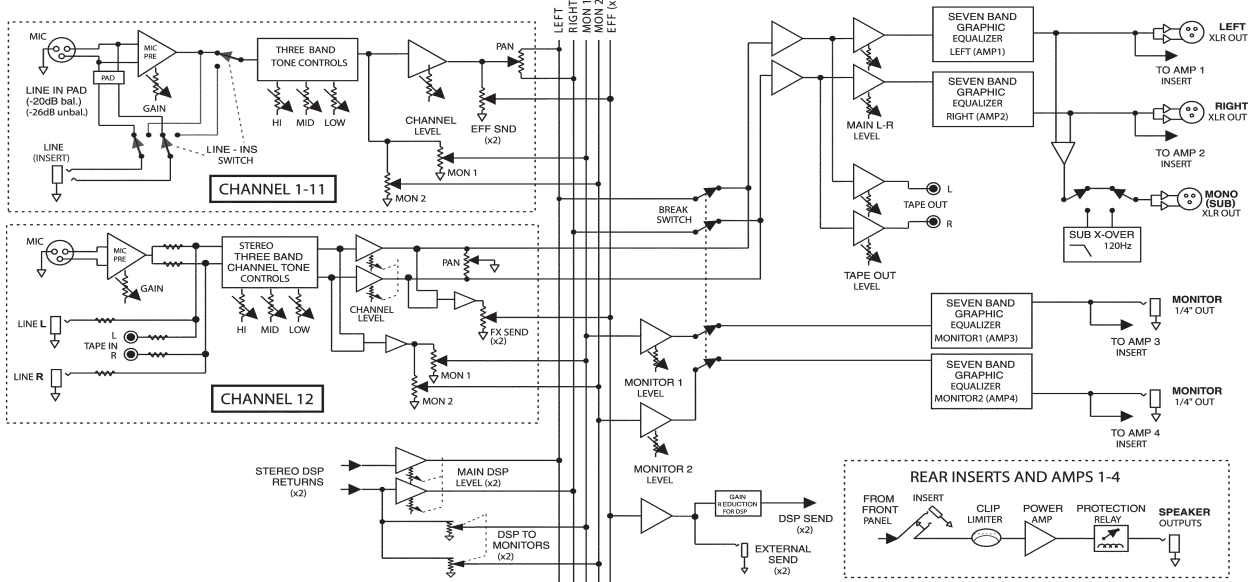

RX1200L in RW6 Road Warrior Case with two USM16 wireless receivers
20.75"W x 12"H x 18"D (without lids)

RX1200L BLOCK DIAGRAM



 This symbol is intended to alert the user to the presence of uninsulated "dangerous voltage" within the product's enclosure that may be of sufficient magnitude to constitute a risk of electric shock to persons.

CAUTION
RISK OF ELECTRIC SHOCK
DO NOT OPEN

 This symbol is intended to alert the user to the presence of important operating and maintenance (servicing) instructions in the literature accompanying the appliance.

IMPORTANT! FOR YOUR PROTECTION, PLEASE READ THE FOLLOWING:

WATER AND MOISTURE: Appliance should not be used near water (near a bathtub, washbowl, kitchen sink, laundry tub, in a wet basement, or near a swimming pool, etc). Care should be taken so that objects do not fall and liquids are not spilled into the enclosure through openings.

POWER SOURCES: The appliance should be connected to a power supply only of the type described in the operating instructions or as marked on the appliance.

GROUNDING OR POLARIZATION: Precautions should be taken so that the grounding or polarization means of an appliance is not defeated.

POWER CORD PROTECTION: Power supply cords should be routed so that they are not likely to be walked on or pinched by items placed upon or against them, paying particular attention to cords at plugs, convenience receptacles, and the point where they exit from the appliance.

SERVICING: The user should not attempt to service the appliance beyond that described in the operating instructions. All other servicing should be referred to qualified service personnel.

FUSING: If your unit is equipped with a fuse receptacle, replace only with the same type fuse. Refer to replacement text on the unit for correct fuse type.

SAFETY INSTRUCTIONS (EUROPEAN)

The conductors in the AC power cord are colored in accordance with the following code.

GREEN & YELLOW—Earth BLUE—Neutral BROWN—Live

U.K. MAIN PLUG WARNING: A molded main plug that has been cut off from the cord is unsafe. NEVER UNDER ANY CIRCUMSTANCES SHOULD YOU INSERT A DAMAGED OR CUT MAIN PLUG INTO A POWER SOCKET.

LIMITED WARRANTY

Your Carvin product is guaranteed against failure for 1 YEAR unless otherwise stated. Carvin will service and supply all parts at no charge to the customer providing the unit is under warranty. Shipping costs are the responsibility of the customer. CARVIN DOES NOT PAY FOR PARTS OR SERVICING OTHER THAN OUR OWN. A COPY OF THE ORIGINAL INVOICE IS REQUIRED TO VERIFY YOUR WARRANTY. Carvin assumes no responsibility for horn drivers or speakers damaged by this unit. This warranty does not cover, and no liability is assumed, for damage due to: natural disasters, accidents, abuse, loss of parts, lack of reasonable care, incorrect use, or failure to follow instructions. This warranty is in lieu of all other warranties, expressed or implied. No representative or person is authorized to represent or assume for Carvin any liability in connection with the sale or servicing of Carvin products. CARVIN SHALL NOT BE LIABLE FOR INCIDENTAL OR CONSEQUENTIAL DAMAGES.

When RETURNING merchandise to the factory, you may call for a return authorization number. Describe in writing each problem. If your unit is out of warranty, you will be charged the current FLAT RATE for parts and labor to bring your unit up to factory specifications.

SERVICE:

In the USA, please go to www.carvinservice.com

Outside the USA, contact your dealer or go to <http://www.carvinworld.com> for your nearest service center. Include a written description of the problem with serial number and date of purchase.

MAINTAINING YOUR EQUIPMENT

Avoid spilling liquids or allowing any other foreign matter inside the unit. The panel of your unit can be wiped from time to time with a dry or slightly damp cloth in order to remove dust and bring back the new look. As with all pro gear, avoid prolonged use in caustic environments (salt air). When used in such an environment, be sure the mixer is adequately protected by a cover.



CAUTION
RISK OF ELECTRIC SHOCK

REFER SERVICING TO QUALIFIED SERVICE PERSONNEL!
THIS UNIT CONTAINS HIGH VOLTAGE INSIDE!

RX1200R LIVE SETUP

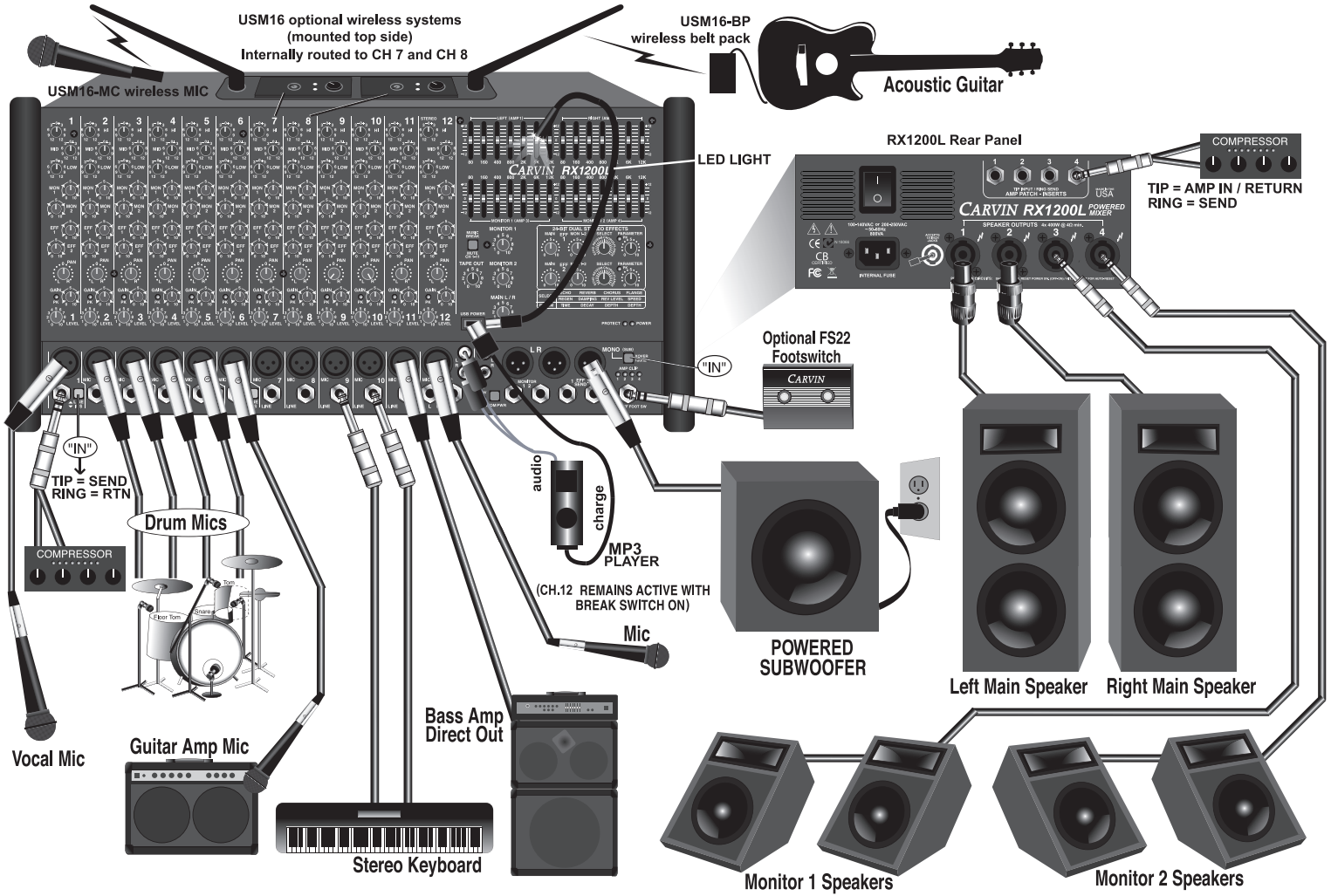

RX1200R LIVE SETUP

