

┌ *MOBILIARIO*
EXTERIOR ─┐



Singular designs,
unique pieces to
share your life

Diseños singulares,
piezas únicas
para compartir
tu vida



timeless designs

The uniqueness of the classics in harmony with the most advanced materials, the highest quality and timeless design, provide a long-lasting life to all our products.

Designed to be part of your life.

diseño atemporal

La singularidad de los clásicos en armonía con los más avanzados materiales, la calidad y el diseño atemporal, proporcionan a toda la gama de productos una larga durabilidad.

Diseñado para ser parte de tu vida.





our project

Quality is in small details.

ARQMAT ensures the quality of all its products, giving special emphasis on small details, to always provide the excellence that you deserve.

nuestro proyecto

La calidad está en los pequeños detalles.

ARQMAT asegura la calidad de todos sus productos, poniendo especial énfasis en los pequeños detalles, para proporcionar siempre la excelencia que se merece.

our mission

Passion, enthusiasm and innovation
in everything we do.

Each of our pieces is designed
with passion and enthusiasm,
characteristics that allow us to
improve year after year making a
strong effort in continuous
improvement and product innovation

nuestra misión

Pasión, entusiasmo e innovación en todo lo que hacemos.
Cada una de nuestras piezas está diseñada con pasión
y entusiasmo, características que permiten que
ARQMAT año tras año ponga máximo esfuerzo en la
mejora continua y en la innovación de nuestros
productos.



content

- | | | | |
|-----|----------------------------|-----|-----------------------------|
| 14 | anthea
by monica armani | 130 | dom+domino
by joan casàs |
| 44 | espiga
by jordi ribaudí | 138 | sálvora
by antoni tarrés |
| 68 | dunas
by jordi ribaudí | 146 | alu4
by kurt thut |
| 80 | milano
by joan gaspar | 152 | barcino
by joan casàs |
| 96 | lucca
by joan casàs | 158 | toledo
by jorge pensi |
| 120 | siena
by joan casàs | 168 | parís
by jorge pensi |
| | | 172 | technical |

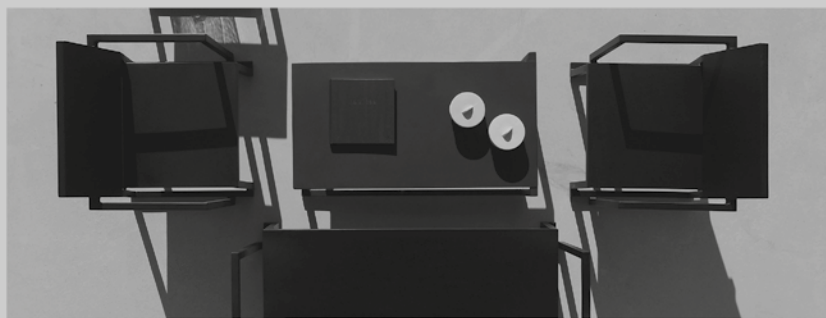



anthea



by
monica armani



Color; solutions for innovative textiles, the figure for my design are the ingredients for this new outdoor collection. Sofas, wide armchairs, seatings, an innovative pool bed, completed by a range of tables, side and coffee tables. All creating Monica Armani's "world" for Indecasa. My work focuses on creating harmony between form, research and timeless design. The ANTHEA collection is the result: the backrests of the seatings are covered with an elastic strip which I dignified with a textile ribbon of my design. The three-dimensional effect and the chromatic vibration therefore create an innovative and unique detail.

ANTHEA is built with aluminium, a material which is both valuable and mouldable. For the objects in this collection I designed dedicated extrusions and a series of components for the die casted junctions and legs. I then worked with the tube to realize the backrests and the pool bed. This material, with its characteristics, represents the DNA of **ARQMAT**. The Spanish company, in its prestigious history, created iconic objects in aluminium. Working on this collection, which represents a new journey for **ARQMAT** – my choice of material was therefore apparent – enabled me to create a series of details which together make ANTHEA recognizable and unique. ANTHEA was born in the sun. The wide range of choice in pastel colors and textile combinations enable to create numerous moods which can adapt to any kind of situation and atmosphere.

El color, las soluciones para innovaciones textiles, y la forma de mi diseño son los ingredientes para esta nueva colección de muebles de exterior: Sofás, amplios sillones, sillas, y una innovadora hamaca, completados con una amplia gama de mesas, mesa lateral y mesita de café, crean el "mundo" Monica Armani para **ARQMAT**. Mi trabajo se basa en crear armonía entre las formas, la innovación y el diseño atemporal. La colección ANTHEA es el resultado: los respaldos de los asientos están cubiertos con tiras elásticas y enriquecidas con una cinta tejida de diseño propio. El efecto tridimensional y la vibración cromática crean un detalle vanguardista y único.

ANTHEA está construida en aluminio, un material valioso y moldeable. Para las piezas de esta colección, he diseñado las extrusiones – hechas a medida – así como una serie de componentes para las articulaciones y la estructura de fundición. Posteriormente, trabajé la estructura de los respaldos y de la hamaca. Este material, con sus características, representa el ADN de **ARQMAT**.

La compañía española, a lo largo de su prestigiosa historia, ha creado objetos icónicos en aluminio. Trabajando en esta colección, que representa una nueva etapa para **ARQMAT** – mi elección del material fue, por lo tanto, evidente – permitiéndome crear una serie de detalles que, en su conjunto, hacen que la colección ANTHEA sea reconocible y única. ANTHEA nació bajo el sol. El amplio abanico de posibilidades en colores pastel y las distintas combinaciones de tejidos permiten crear múltiples ambientes que pueden adaptarse a cualquier situación y atmósfera.











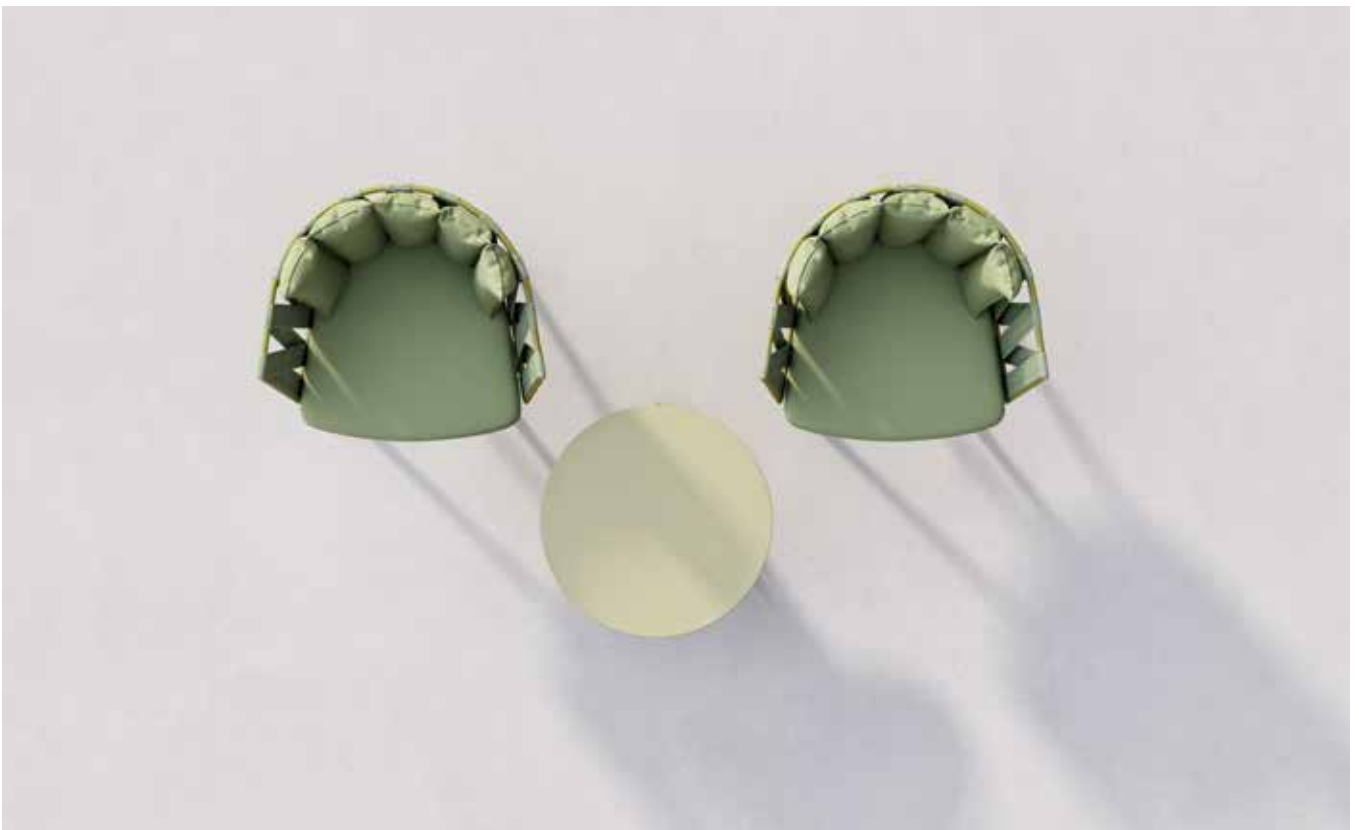

































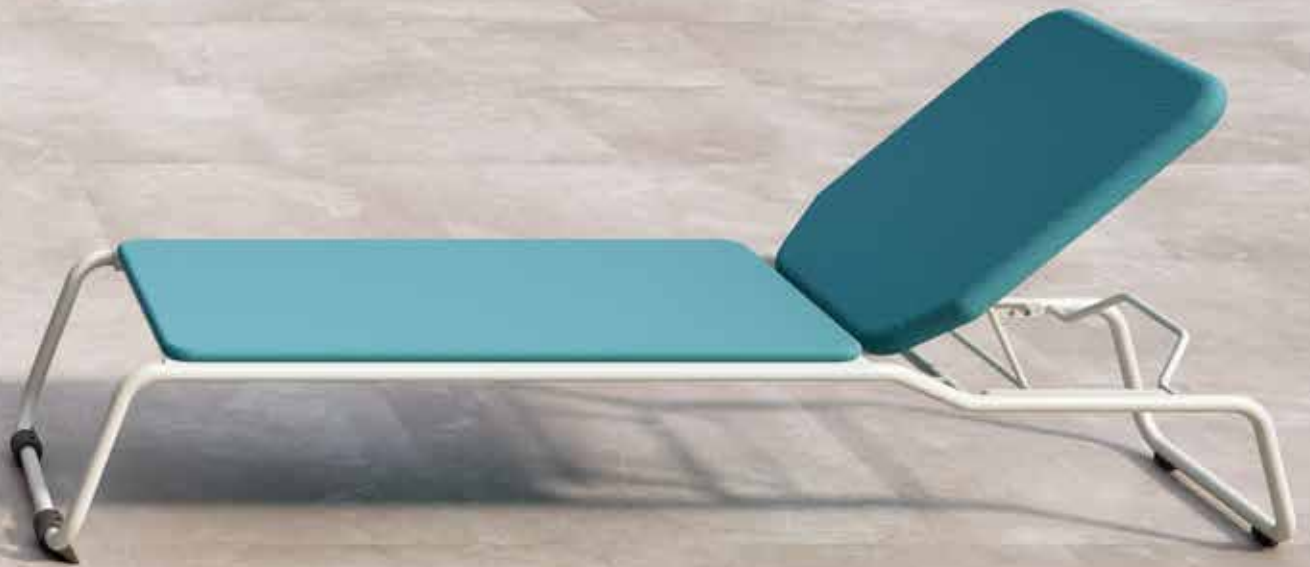













espiga



by
jordi ribaudí



Espiga, its name defines it. Merging the functional with the emotional. Recovering and highlighting what is useful and beautiful in our culture to create a striking collection due to its attractive geometric and organic rhythm. It reflects the ancient way of weaving which has always been there, primitive, simple, intimate and at the same time intelligent.

Elegante, versátil, hacen de esta colección perfecta para cualquier ocasión. Espiga, su nombre la define. Fusionar lo funcional con lo emocional. Recuperar y hacer visible lo útil y lo bello de nuestra cultura para crear una colección que sorprende por su atractivo ritmo geométrico a la vez que orgánico. En ella se refleja esa ancestral forma de tejer que siempre ha estado ahí, primitiva, sencilla, cercana y a la vez tan inteligente.







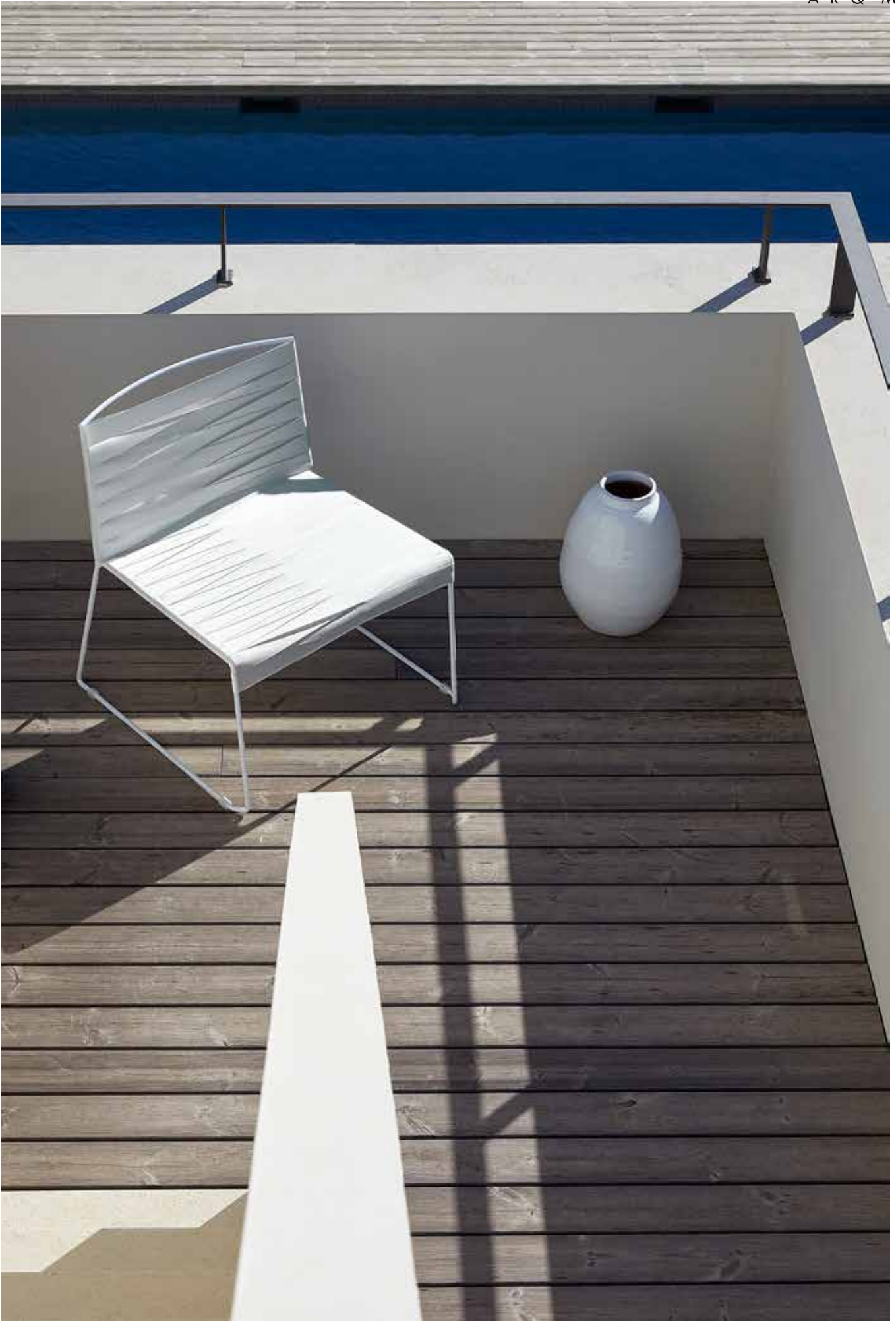











ARQ MAT
www.arqmat.com















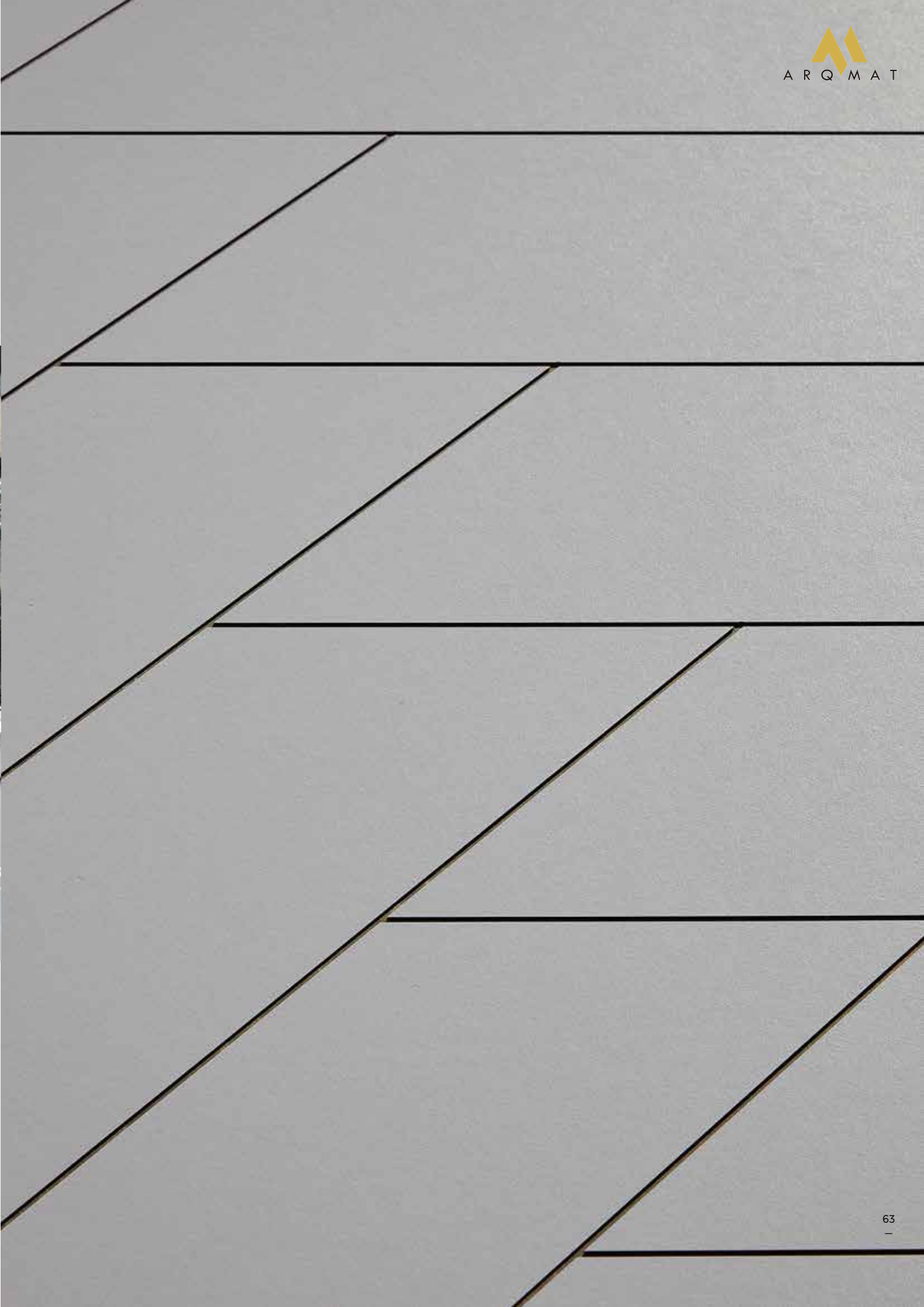











dunas



by
jordi ribaudí



Dunas is a collection of rounded and friendly lines designed to adapt to all environments and climates. With its youthful forms, Dunas offers versatility and modernity able to fit in the most unsuspected places

Dunas es una colección de líneas redondeadas y amables diseñada para adaptarse a todos los entornos y climas. Con sus formas juveniles, Dunas ofrece una versatilidad y modernidad capaz de encajar en los lugares más insospechados.





















milano



by
joan gaspar



Milano, a sober, elegant and versatile line, gives a distinguished touch to any space. The delicate style and maximum durability of this collection make it adaptable to different and unique environments.

Milano, de línea sobria, elegante y versátil, confiere un aire distinguido a cualquier espacio. El estilo delicado y la máxima durabilidad de esta colección permiten su adaptación a entornos diferentes y singulares.





























lucca



by
joan casàs

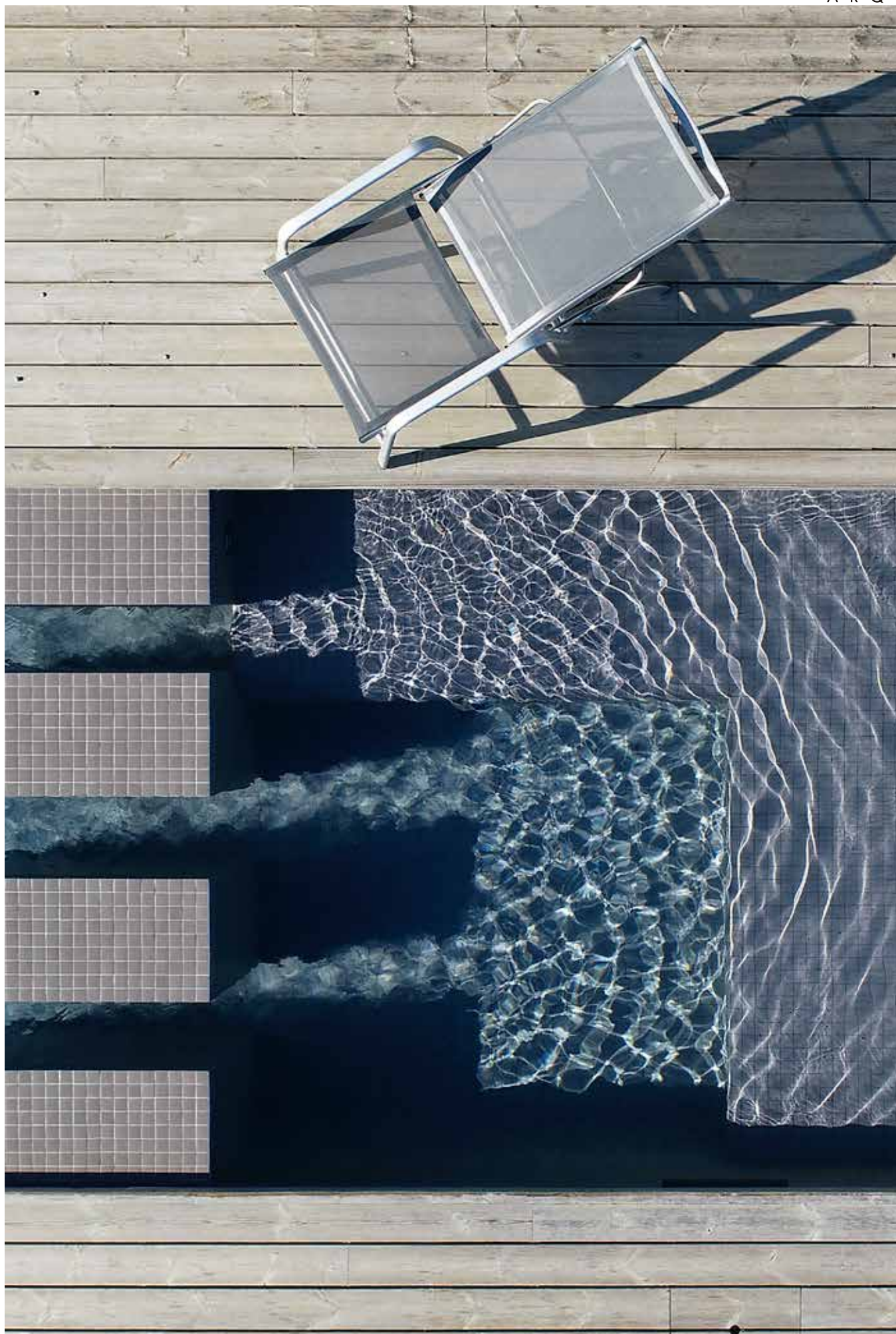

Lucca is a versatile, elegant collection, with different sizes and finishes in its different variants. With noble materials and maximum durability. Designed to satisfy the most luxurious demands, with a timeless design that is distinguished by its elegance in any space.

Lucca es una colección versátil, elegante, con dimensiones y acabados diferentes en sus distintas variantes. Con materiales nobles y de una durabilidad máxima. Diseñada para satisfacer las exigencias más lujosas, un diseño atemporal que se distingue por su elegancia en cualquier espacio.













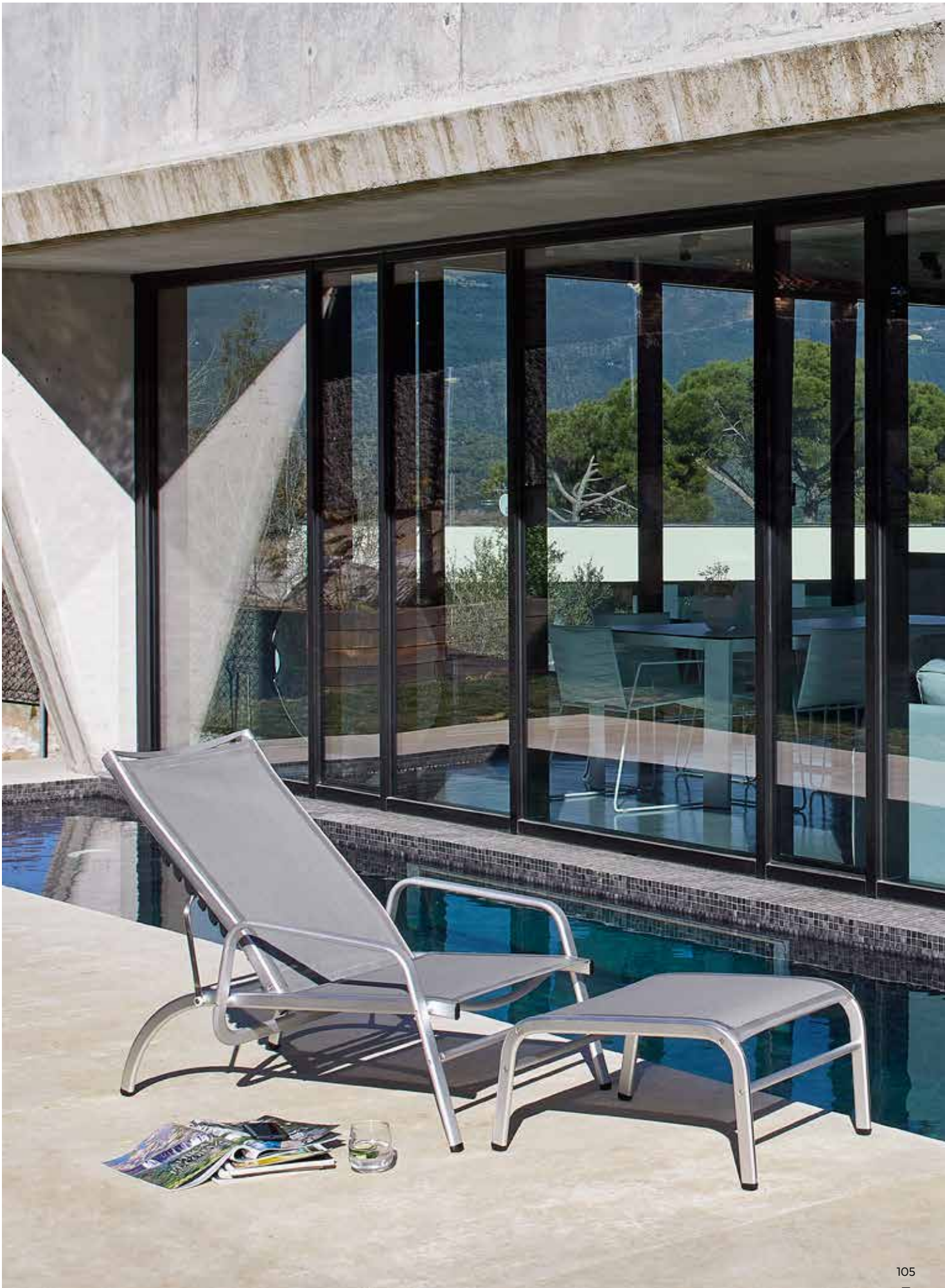



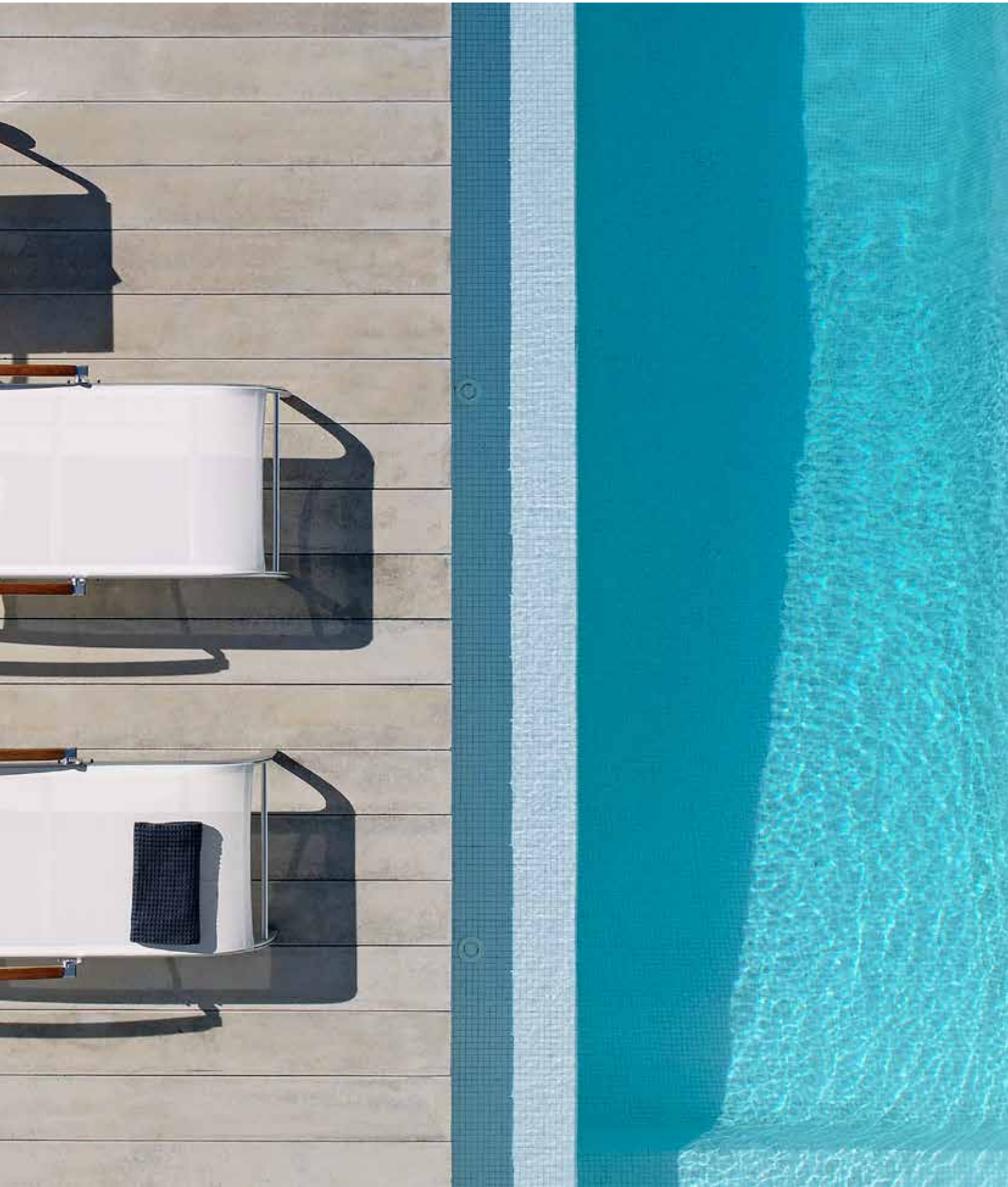













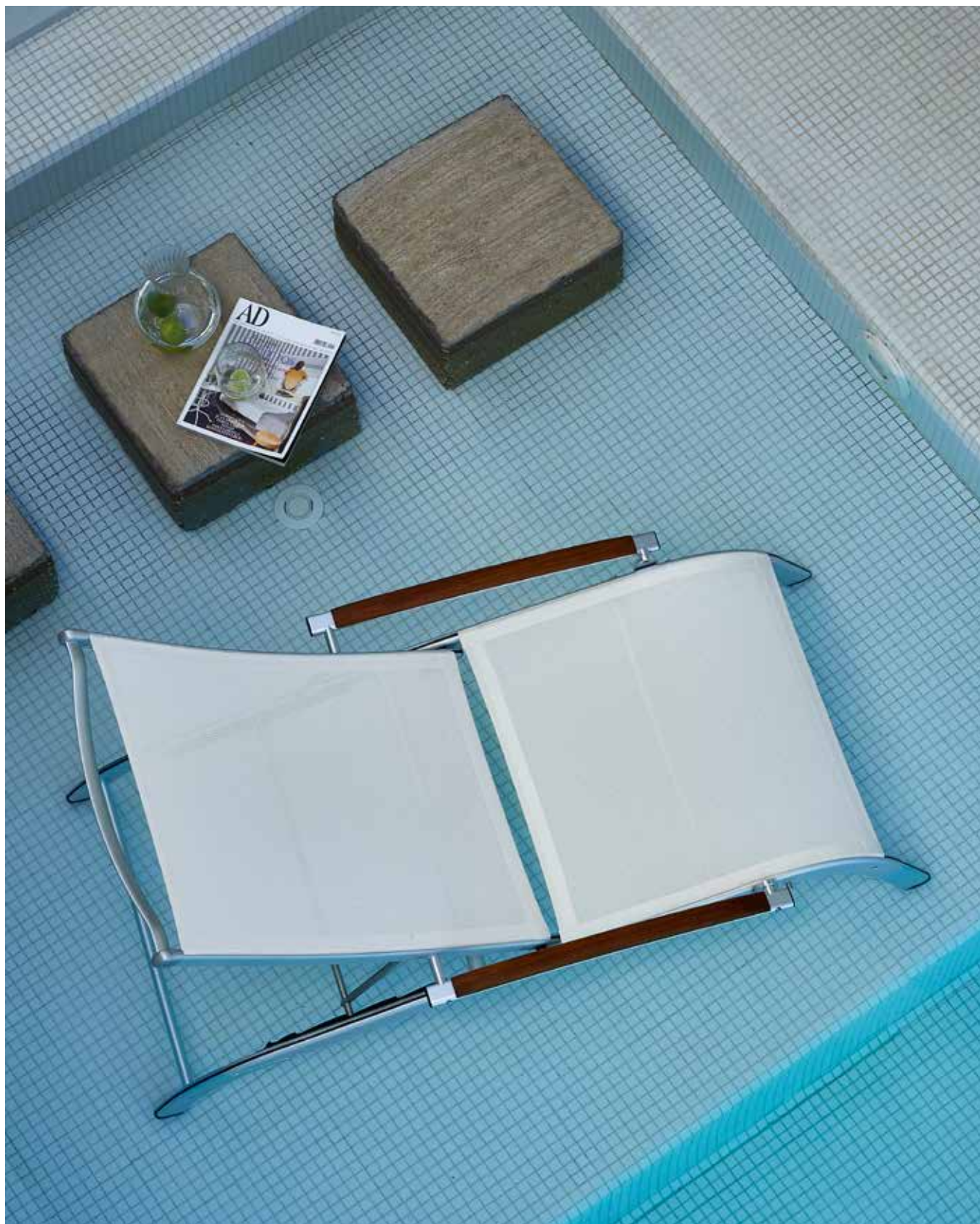









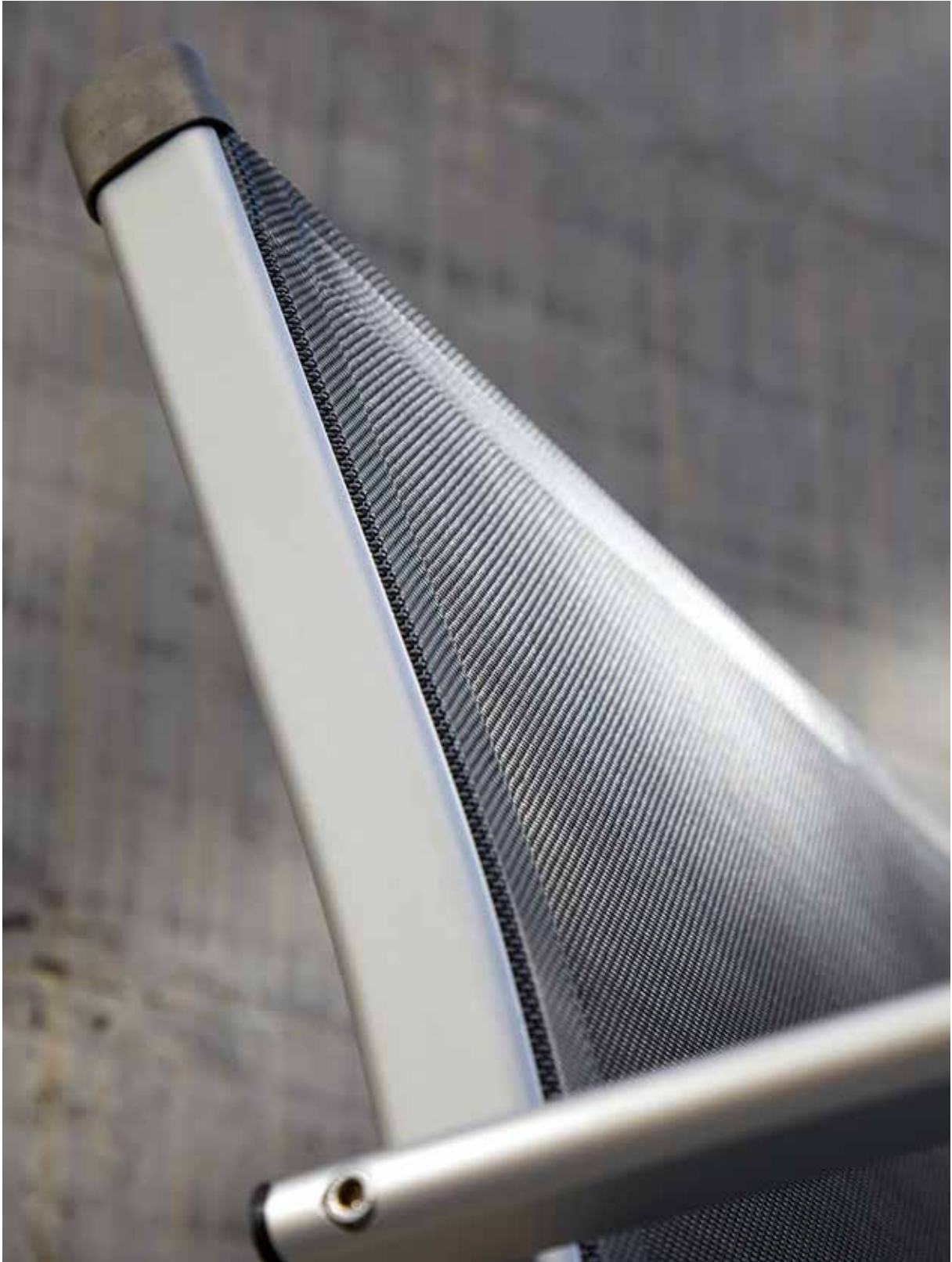

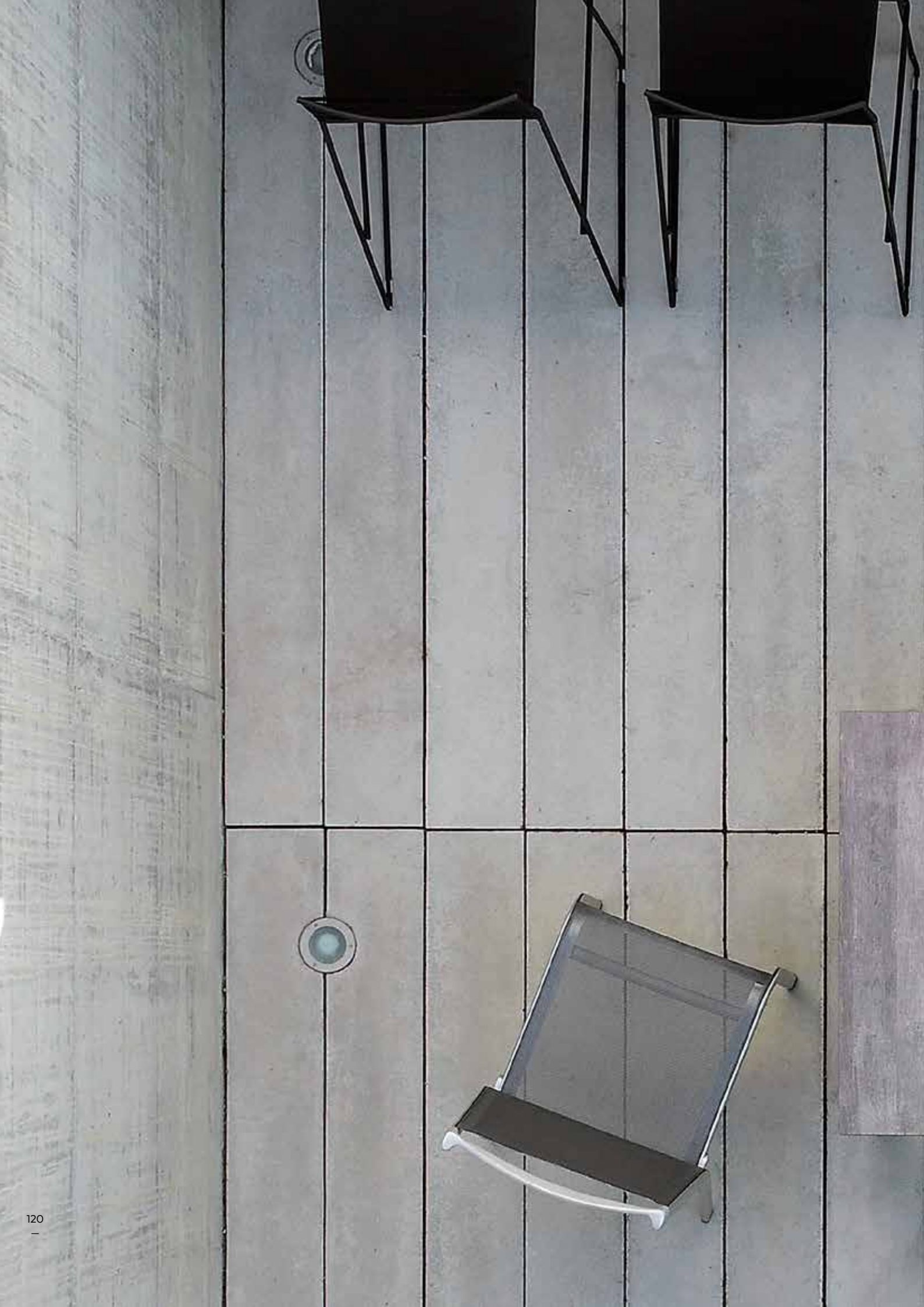

siena



by
joan casàs



The Siena chair stands out due to its light and transparency. Comfort and ergonomics for cozy environments where it is crucial to take full advantage of the space. A versatile design with indisputable elegance and comfort

La silla Siena se distingue por la luz y la transparencia. Confort y ergonomía para ambientes acogidos donde el aprovechamiento del espacio es fundamental. Diseño versátil y de indiscutible elegancia y comodidad.





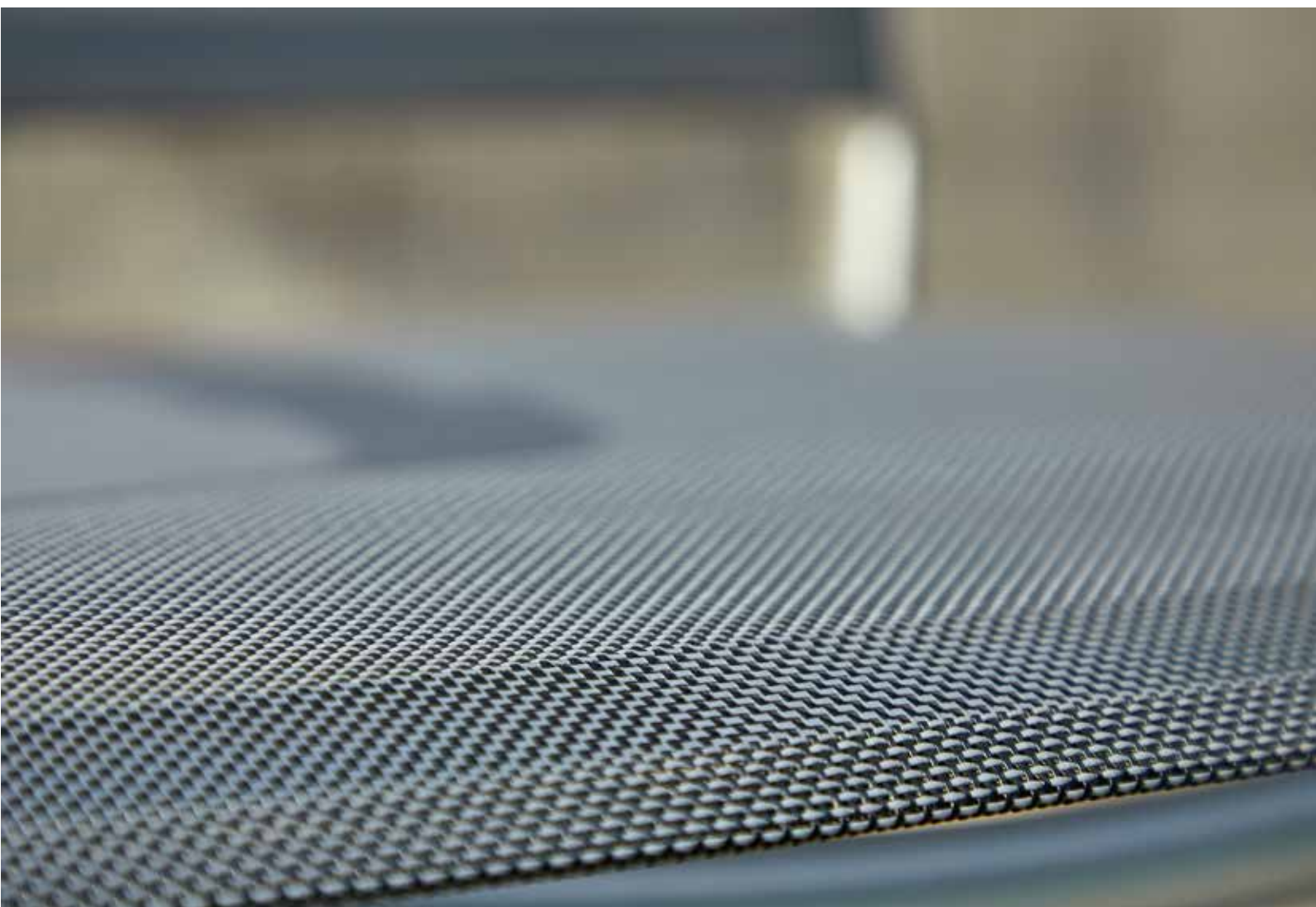











dom
+ domino



by
joan casàs



The series Dom tables denotes strength and design. Their clean and well-defined lines provide elegance and sobriety to any space.

Domino is elegance in aluminum, with soft and compact lines, giving off character and simplicity. Available in different sizes, they can work in any space.

La serie de mesas Dom significa fortaleza y diseño. Sus líneas limpias y bien definidas son capaces de brindar elegancia y sobriedad a cualquier espacio.

Domino es elegancia en aluminio, de líneas suaves y compactas, desprenden carácter y sencillez. Presentadas en diferentes medidas, se adaptan a cualquier espacio.









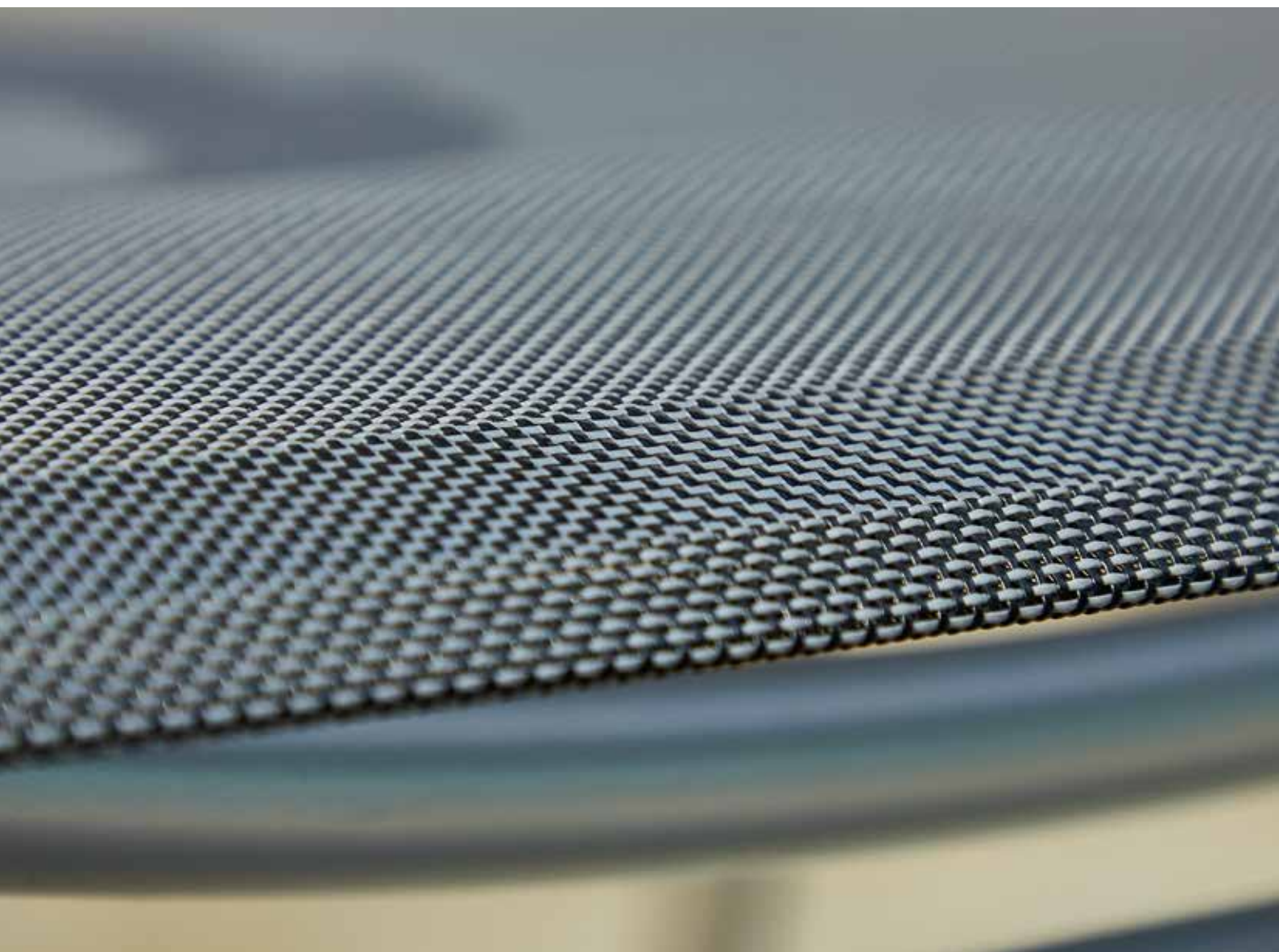



sálvora



by
antoni tarrés



Sálvora is the name of a small island on the Atlantic coast, considered to be a sacred place by ancient Celtic settlers. Sálvora is a sun lounger with an island outline. A simple, compact, comfortable, strong and desirable line, with incomparable elegance.

Sálvora es el nombre de una pequeña isla de la costa atlántica, considerada lugar sagrado por los antiguos pobladores celtas. Sálvora una tumbona con silueta de isla. Una línea simple, compacta, cómoda, robusta y deseable, con una elegancia incomparable.













alu4



A R Q M A T

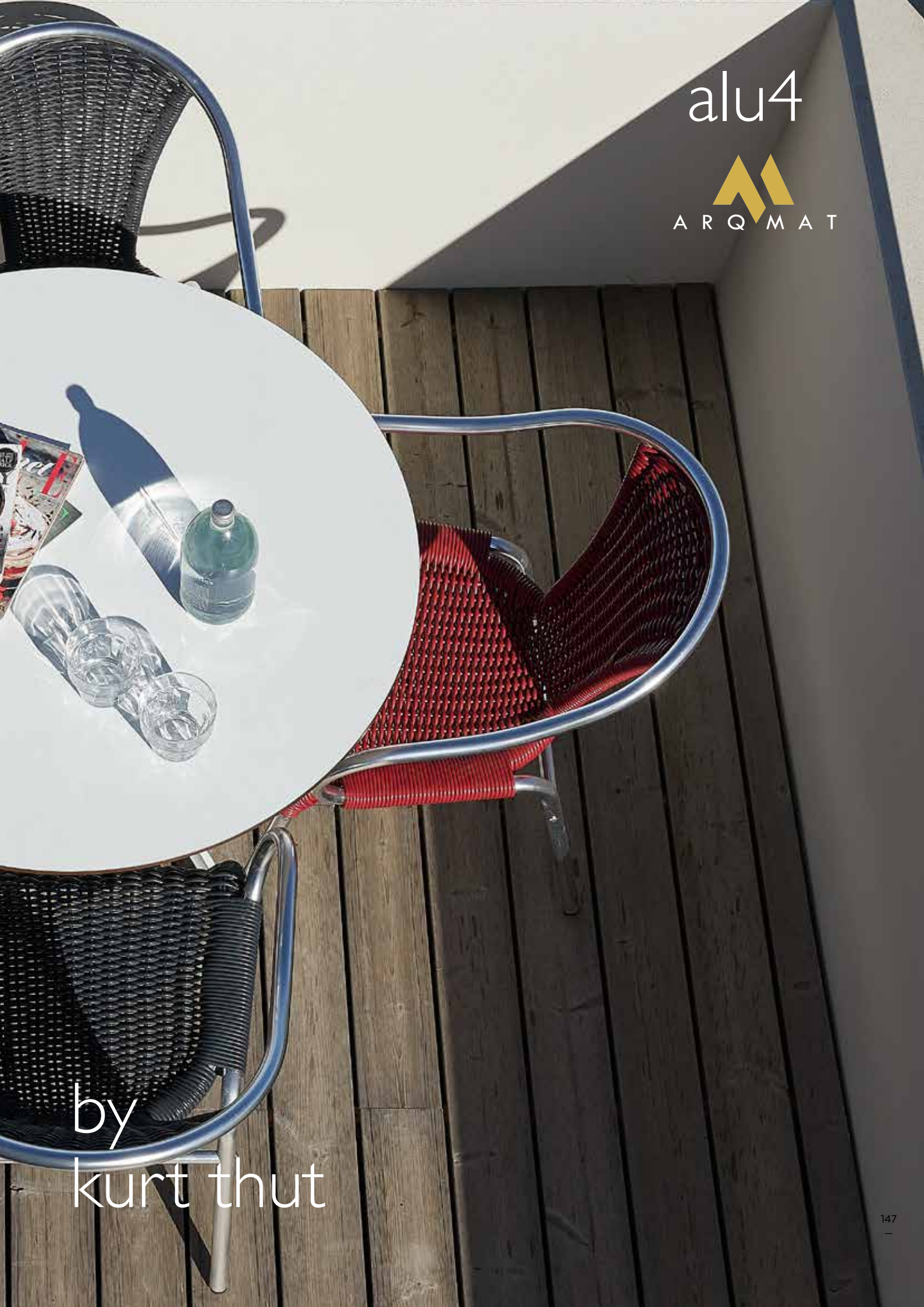

by
kurt thut



Alu denotes the purest aesthetic with all the properties of aluminum. Clean lines for a tribute to a great architect which combines cast aluminum with the use of a solid oval profile. Minimalist and elegant, the Alu table gives versatility to any space.

Alu significa la estética más depurada con todas las cualidades del aluminio. Líneas limpias para el tributo a un gran arquitecto que combina la fundición de aluminio con la utilización de un perfil macizo de sección ovalada. Minimalista y elegante, la mesa Alu confiere versatilidad a cualquier espacio.



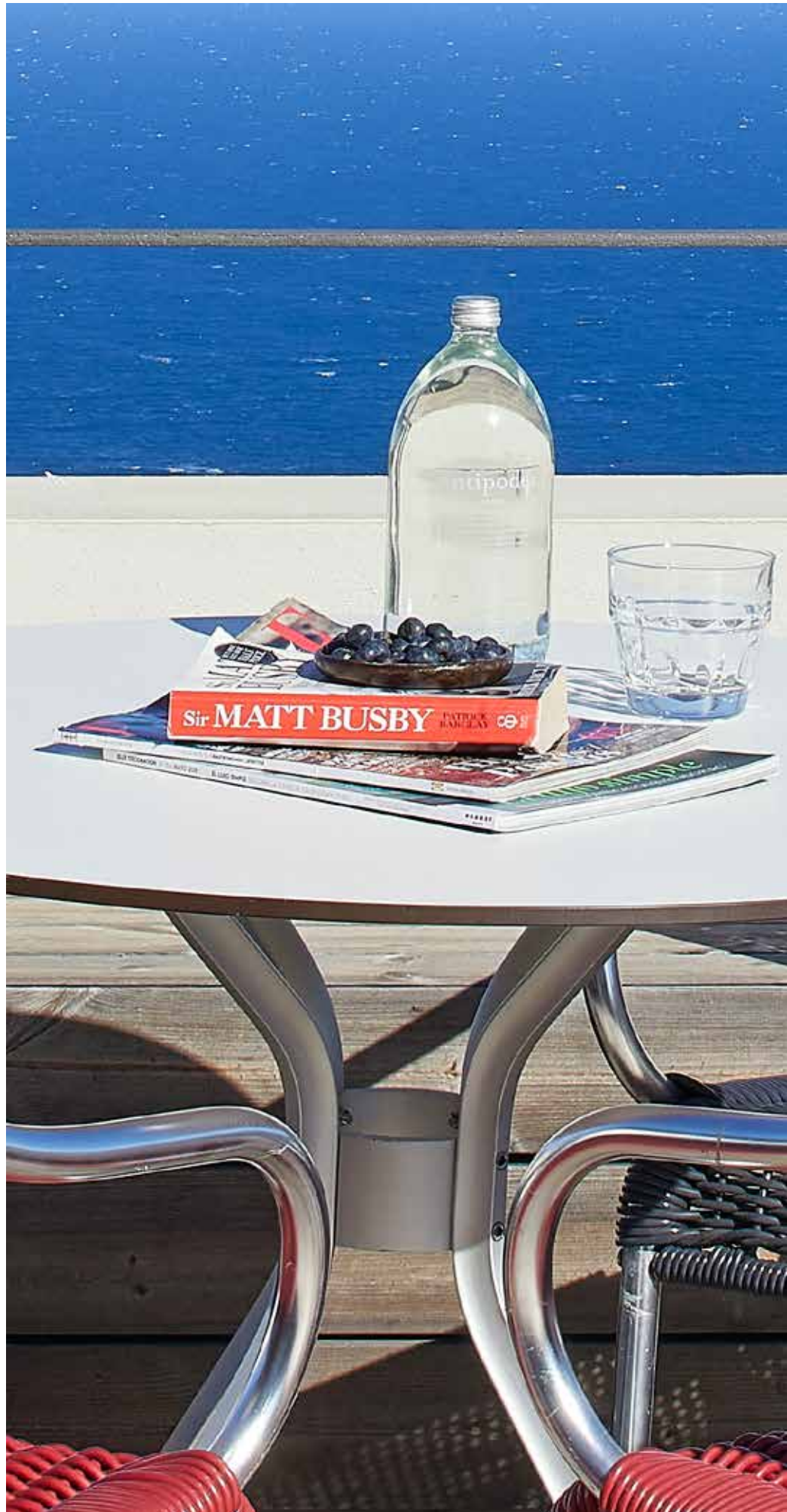





barcino classic



by
joan casas



It is Considered the most famous terrace chair in the world and known as “The Spanish Chair”. An icon of Mediterranean culture. With distinctive, comfortable and light lines, designed in 1964 and recognized worldwide as one of the 100 best chairs of our times.

Considerada la silla de terraza más famosa del mundo y conocida como “The Spanish chair”. Icono de la cultura mediterránea.

De líneas inconfundibles, cómoda y ligera, diseñada en 1964 y reconocida mundialmente como una de las 100 mejores sillas de nuestros tiempos.





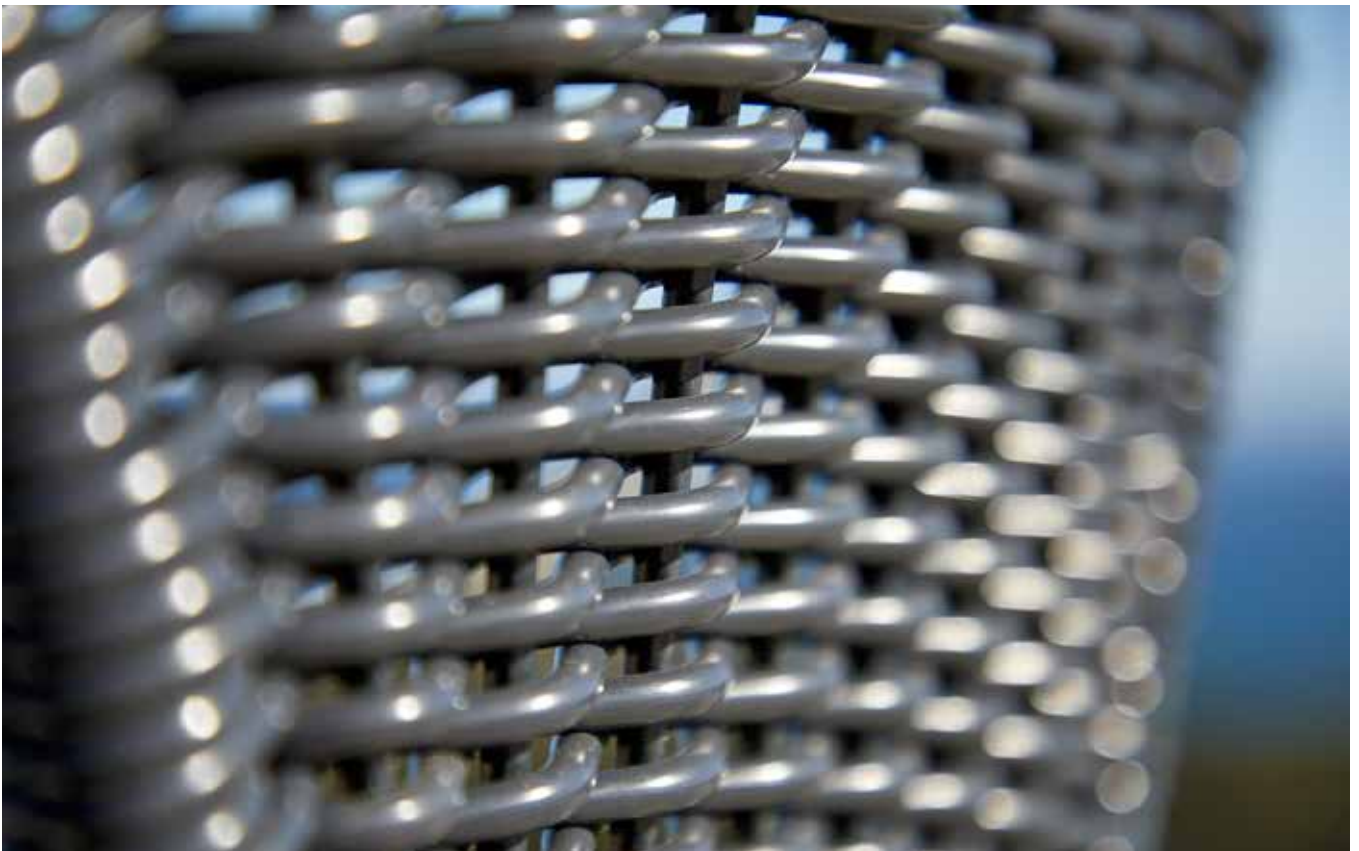



toledo



by
jorge pensì



One of the chairs with more charisma and history, awarded with various awards such as the Silver Delta in 1998 or the AEPD Prize as the best product of the decade. Sober and elegant, it becomes the queen of the party

Una de la sillas con más carisma e historia, galardonada con diversos premios como el Delta de plata en 1998 o el AEPD Prize como mejor producto de la década. Sobria y elegante, se convierte sin duda en la reina de la fiesta













parís



ARQMAT



by
jorge pensi



Distinctive piece of the most prestigious terraces in Paris, the table with the same name stands out by its robustness and its essential and elegant lines indispensable to create outdoor spaces at the highest level.

Inconfundible pieza de las terrazas más prestigiosas de París, la mesa del mismo nombre destaca por su robustez y sus líneas sobrias, de una durabilidad singular, la hacen indispensable para crear estancias exteriores del más alto nivel.









technical



easy chair

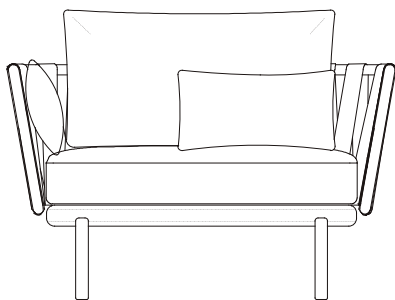

Asiento individual con estructura de aluminio lacado, cojines y tapizados idóneos para el exterior; y respaldo en cinta de pasamanería trenzada sobre tubo de aluminio. Amplia gama cromática y combinaciones para escoger entre cojines opcionales. Apto para exterior.

- Individual seat with a lacquered aluminium structure, with cushions and upholstery suitable for the outdoors and braided ribbon backing on aluminium tubing. Wide colour range and combinations to choose between optional cushions. Suitable for outdoors.

-
Material: aluminio lacado
Material: lacquered aluminium
Color combinations see page 180-181

W98xL91xH61cm
W38.5xL36xH24 inch

Para accesorios adicionales ver página 182-183
For additional accessories see page 182-183

sofa 2-3 seat

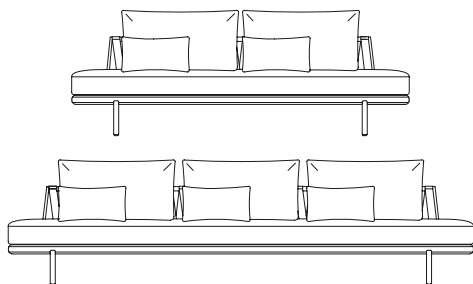

Asiento de 2 y 3 plazas con estructura de aluminio lacada, cojines y tapizados idóneos para el exterior; y respaldo en cinta de pasamanería trenzada sobre tubo de aluminio. Amplia gama cromática y combinaciones para escoger entre cojines opcionales. Apto para exterior.

- 2- and 3-seater sofa with lacquered aluminium structure, cushions and upholstery suitable for outdoors, and braided ribbon backing on aluminium tubing. Wide colour range and combinations to choose between optional cushions. Suitable for outdoors.

-
Material: aluminio lacado
Material: lacquered aluminium
Color combinations see page 180-181

-
W87xL275xH60cm
W34xL108.3xH23.5 inch

Para accesorios adicionales ver página 182-183
For additional accessories see page 182-183

ottoman

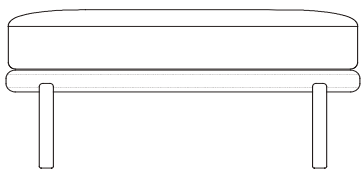

Asiento individual con estructura de aluminio lacada, cojines y tapizados idóneos para el exterior. Amplia gama cromática y combinaciones para escoger. Apto para exterior.

- Individual seat with lacquered aluminium structure, cushions and upholstery suitable for outdoors. Wide colour range and combinations to choose from. Suitable for outdoors.

-
Material: aluminio lacado
Material: lacquered aluminium
Color combinations see page 180-181

-
W79xL75xH37cm
W31xL29.5xH14.7 inch

Para accesorios adicionales ver página 182-183
For an additional accessories see page 182-183

coffee table

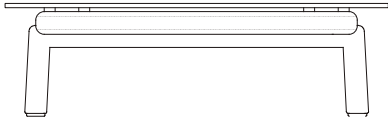

Mesa auxiliar para los asientos bajos de Anthea, estructura idéntica a la colección y sobre en compacto o cristal templado.

Apta para exterior.

- Side table for the Anthea low seats; structure identical to the collection, compact top and tempered glass. Suitable for outdoors.

- Material: aluminio lacado

Material: lacquered aluminium

Color combinations see page 180-181

- W79xL79xH25cm

W31xL31xH9.8 inch

dining table

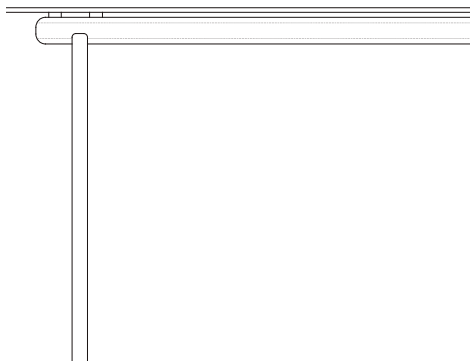

Mesa de comedor con estructura en aluminio de fundición y extrusión, y top en compacto o cristal templado.

Apta para exterior.

- Dining table with structure in cast and extruded aluminium, compact top and tempered glass. Suitable for outdoors.

- Material: aluminio lacado

Material: lacquered aluminium

Color combinations see page 180-181

- W 81xL210xH74cm

W31.7xL82.5xH29 inch

chair

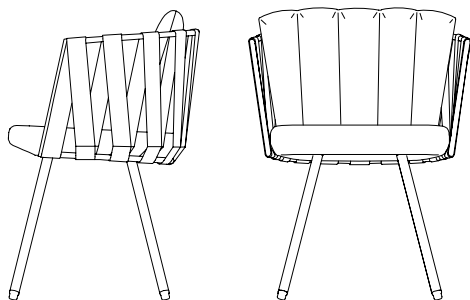

Asiento individual con estructura de aluminio lacada, cojines y tapizados idóneos para el exterior, y respaldo en cinta de pasamanería trenzada sobre tubo de aluminio. Amplia gama cromática y combinaciones para escoger entre cojines opcionales. Apto para exterior.

- Individual seat with a lacquered aluminium structure, with cushions and upholstery suitable for the outdoors and braided ribbon backing on aluminium tubing. Wide colour range and combinations to choose between optional cushions. Suitable for outdoors.

- Material: aluminio lacado

Material: lacquered aluminium

Color combinations see page 180-181

- W60xL52xH73

W24xL20.5xH29

pool bed



Pool bed compatible con el resto de los acabados de la serie.
Inclinación graduable, complementa el espacio exterior con el resto de mobiliario y accesorios de la serie.

-
Pool bed compatible with the rest of the finishes in the series.
Adjustable tilt, complements the outer area with the rest of the furniture and accessories in the series.

-
Material: Acero inoxidable lacado
Material Lacquered stainless steel
Color combinations see page 180-181

-
W66xL213xH39 cm
W25.7xL83.8xH15.4 inch

side table

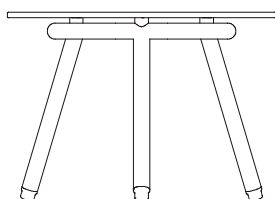

Mesa baja de acompañamiento con estructura en tubo de aluminio y sobre en compacto o cristal templado.

Apta para exterior.

-
Low accompanying table with aluminium tubing structure, compact top and tempered glass. Suitable for outdoors.

-
Material: aluminio lacado
Material: lacquered aluminium
Color combinations see page 180-181

-
Ø50x35 cm
Ø19.7xH13.7 inch

Sofás, butaca y puf: bastidor/plataforma diseñado y realizado en aluminio extrusionado, con uniones realizadas mediante fundición a presión; capas de tejidos Batyline, tono sobre tono, crean el soporte de los asientos tapizados.

El sistema de patas a puente, en fundición a presión, completa las bases, que pueden ser simples o compuestas. Una serie de respaldos lineares, decorados por bandas” a “L”, a “C”, permiten configurar sofás con dos y tres plazas, y el sillón y los sofás modulares en todas las formas.

Poolbed: realizado con un único tubo y redondo en acero inox, creando la estructura para la tumbona en Batyline, se inclina bajo el respaldo para crear el punto de apoyo, el bastidor y el soporte. El respaldo en forma está acolchado y tapizado en tela.

Sillas y sillón: las patas en tubo de aluminio están soldadas a una placa estructural conectada a la cesta/respaldo “con bandas”. Una silla acolchada estructurada crea el asiento y rompe las tiras laminadas de las espaldas, creando un detalle particular para estas sesiones.

Mesas, mesa lateral y mesa de centro: las estructuras están fabricadas con un bastidor en aluminio extrusionado y uniones fundidas; las patas del puente también son realizadas mediante fundición a presión. El diseño incorpora los detalles del sistema de sofás. Los sobres están realizadas en compacto laminado o en cristal templado.

Sofas, armchairs and poufs: frame/platform realized with an aluminium extrusion and diecasted junctions, tesano layer in Batyline, tone on tone, creating a stuffed seating. The diecasted bridge leg system completes the base that can be single or mounted with each other. A series of covered backseats, L or C shaped, enable to configure two or three seat sofas, both the armchair and the sofa are modular in all forms.

Poolbed: realized with a round inox tube, worked continuously, that creates the structure for the Batyline small bed and tapers under the pivoting backrest to create its fulcrum, the rack and the support. The shaped backrest is padded and covered in textile.

Chairs and armchairs: the aluminium tube legs are welded on a structural plate connected to the covered backrest. A structured padding creates the seating and is in direct contrast with the prestigious backrests, creating a peculiar detail.

Tables, side tables, coffee tables: the structures are realized with an aluminium extruded frame and diecasted junctions, the bridged legs are also diecasted. The design recalls the detail used for the sofa system. The planes are realized in laminated compact or tempered glass.

anthea sofá system compositions

combination a ibiza

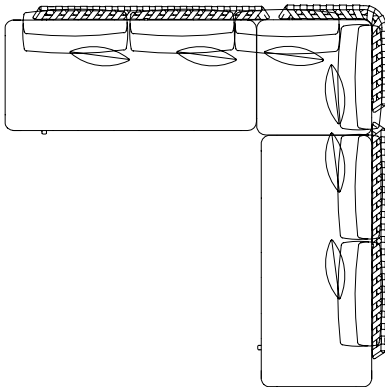

2 sofás de 2 plazas y un corner.

-
2 Two-seater sofas with a corner sofa

-
259x259x60 cm
102x102x23.5 inch

Para accesorios adicionales ver página 182-183
For additional accessories see page 182-183

combination b santorini

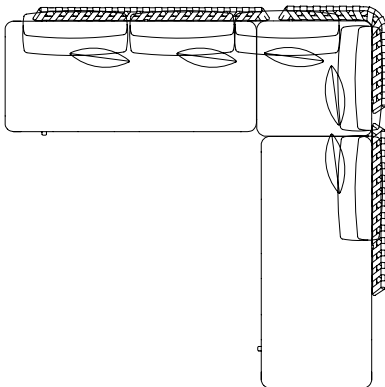

1 sofá de 2 plazas, 1 sofá de 2 plazas con respaldo parcial y un corner.

-
1 Two-seater sofa, 1 two-seater sofa with partial backrest

-
259x259x60 cm
102x102x23.5 inch

Para accesorios adicionales ver página 182-183
For additional accessories see page 182-183

combination c creta

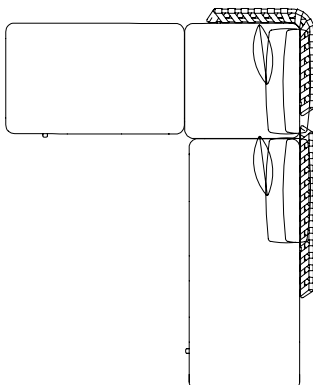

1 sofá de 2 plazas con respaldo parcial, un diván y un corner.

-
1 two-seater sofa with partial backrest, a divan and a corner sofa

-
209x259x60 cm
82.4x102x23.5 inch

Para accesorios adicionales ver página 182-183
For additional accessories see page 182-183

combination d corfú

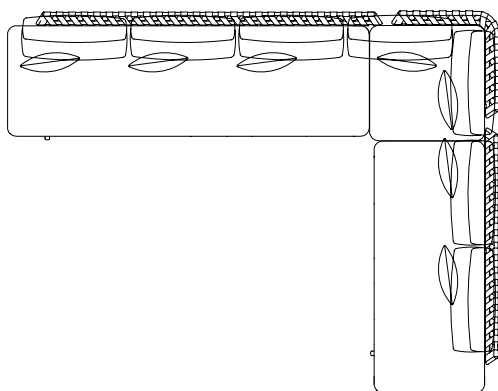

I sofá de 3 plazas, I sofá de 2 plazas y un corner.

- I three-seater sofa, I two-seater sofa and a corner sofa

- 334x259x60cm
131.6x102x23.5in

Para accesorios adicionales ver página 182-183
For additional accessories see page 182-183

combination e capri

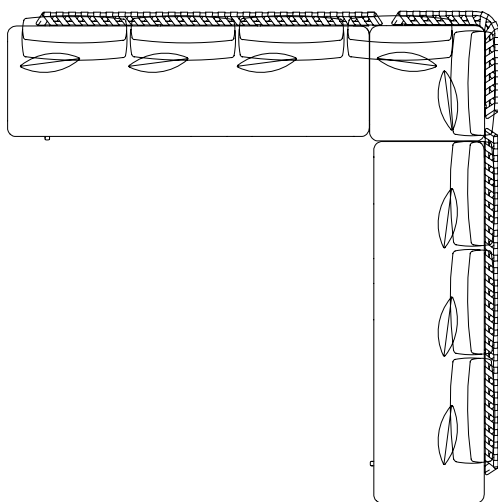

2 sofás de 3 plazas y un corner.

- 2 three-seater sofas and a corner sofa

- 334x334x60 cm
131.6x131.6x23.5 inch

Para accesorios adicionales ver página 182-183
For additional accessories see page 182-183

combination f corcega

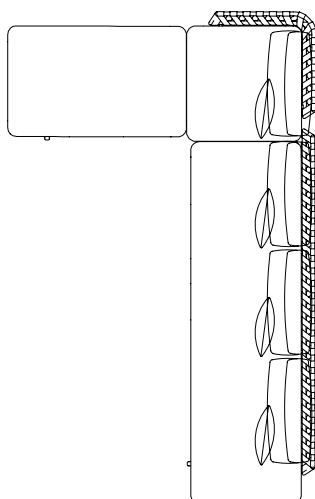

I sofás de 3 plazas, un diván y un corner.

- I three-seater sofa, a divan and a corner sofa

- 209x334x60 cm
82.4x131.6x23.5 inch

Para accesorios adicionales ver página 182-183
For additional accessories see page 182-183

combination g sicilia

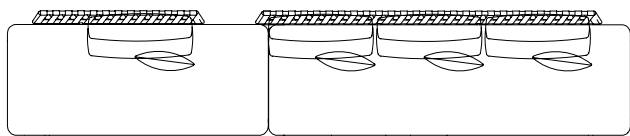

1 sofá de 3 plazas y un sofá de 2 plazas con respaldo parcial.

- 1 three-seater sofa and a two-seater sofa with partial backrest

86x425x60 cm
34x167.3x23.5 inch

Para accesorios adicionales ver página 182-183

For additional accessories see page 182-183

combination h mikonos

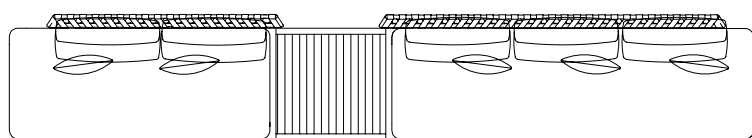

1 sofá de 3 plazas, un sofá de 2 plazas y una mesa de centro.

- 1 three-seater sofa, 1 two-seater sofa and a coffee table

86x500x60 cm
34x196.8x23.5 inch

Para accesorios adicionales ver página 182-183

For additional accessories see page 182-183

moodboards

forest



grove



garden



ocean



plumet



storm



marine

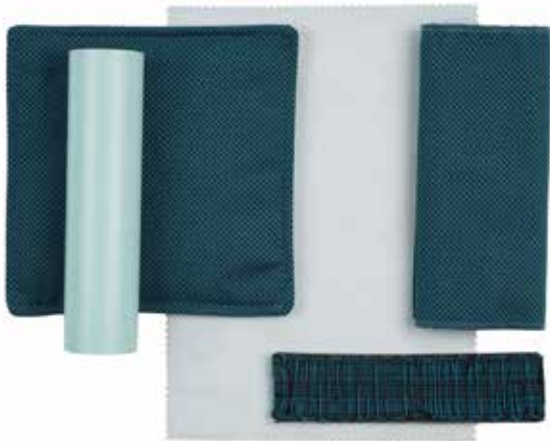

dahlia



sky

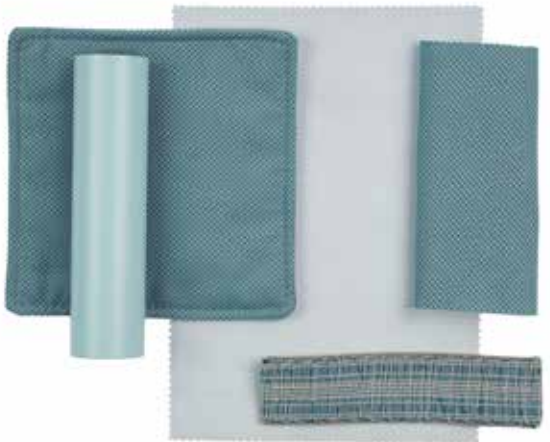

garnet



stream

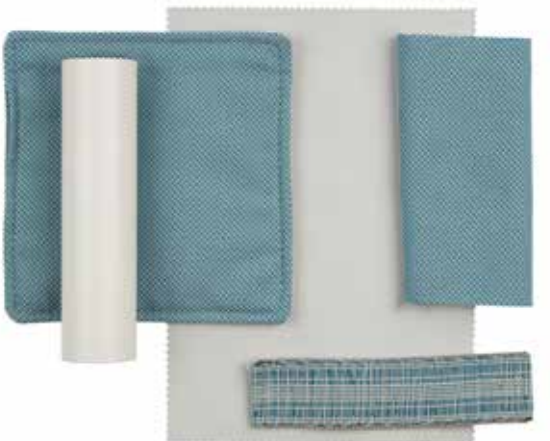

SUN PROTECTION



UV/FADE PROTECTION



WATER AND STAIN PROTECTION

fabrics / telas

celeste



rosato



verde oscuro



pavone



blanco & negro



verde claro



accessories / accesorios



Cojín rectangular / Rectangular cushion
 65x29x12cm
 25.6x11.4x4.7 inch

Cojín / Cushion:
 43x43x12cm
 7x17x4.7 inch

metals / metales



rosa

perla

salvia

cielo

piombo

chair



Silla con estructura patín de acero pintado.
Cinta de polyester ignífuga e hidrófuga.
Tacos antideslizantes.
Tornillería de acero inoxidable.
-
Chair with a painted steel sled-base structure.
Flame-retardant and water-repellent polyester strip.
Anti-slip feet. Screws made of stainless steel.
-
Materials: Painted steel / Polyester
Colour structure: White / Black
-
54,6x57x81x 48,6 cm
21.49x22.44x 31.88 x 19.13 inch

Colour textile



WHITE

BLACK

armchair



Silla con brazos con estructura patín de acero pintado.
Cinta de polyester ignífuga e hidrófuga.
Tacos antideslizantes.
Tornillería de acero inoxidable.
-
Chair with armrests with a painted steel sled-base structure.
Flame-retardant and water-repellent polyester strip.
Anti-slip feet. Screws made of stainless steel.
-
Materials: Painted steel / Polyester
Colour structure: White / Black
-
59,2x57,9x81x48,6x66,4 cm
23.30x22.79x31.88x19.13x26.14 inch

Colour textile



WHITE

BLACK

low chair



Sillón bajo con estructura patín en acero pintado.
Cinta de polyester ignífuga e hidrófuga.
Tacos antideslizantes.
Tornillería de acero inoxidable.
-
Low chair with a painted steel sled-base structure.
Flame-retardant and water-repellent polyester strip.
Anti-slip feet.
Screws made of stainless steel.
-
Materials: Painted steel / Polyester
Colour structure: White / Black
-
68,8x 66,7x75,4x43,1 cm
27.08x 26.25x29.68x 16.96 inch

Colour textile



WHITE

BLACK

stool



Taburete alto con estructura patín en acero pintado.
Cinta de polyester ignífuga e hidrófuga. Tacos antideslizantes. Tornillería de acero inoxidable.

- High stool with a painted steel sled-base structure.
Flame-retardant and water-repellent polyester strip.
Anti-slip feet. Screws made of stainless steel.

- **Materials:** Painted steel / Polyester
Colour structure: White / Black

- **W 47,6 x L 58 x H 98,7 x Hs 80,5 CM**
W 18.74 x L 22.83 x H 38.64 x Hs 31.69 IN

Colour textile



WHITE

BLACK

low table



Mesa baja con estructura patín.
Estructura de acero pintado.
Sobre de fenólico efecto relieve en impresión digital.
Tacos antideslizantes.
Tornillería de acero inoxidable.

- Low table with sled-base structure.
Painted steel structure.
Top made of phenolic with embossing effect in digital printing.
Anti-slip feet.
Screws made of stainless steel.

- **Materials:** Painted steel, HPL
Colour structure: White / Black

- **W 66,2 x L 64,6 x H 29,3 CM**
W 26.06 x L 25.43 x H 11.53 IN

Colour top



WHITE

BLACK

dining table



Mesa con perfiles de aluminio pintados.
Sobre de fenólico efecto relieve en impresión digital.
Tacos antideslizantes.
Tornillería de acero inoxidable.

- Table with painted aluminium profiles.
Top made of phenolic with embossing effect in digital printing.
Anti-slip feet.
Screws made of stainless steel.

- **Materials:** Painted steel, HPL
Colour structure: White / Black

- **W 160 x L 90 x H 75,5 CM**
W 62.99 x L 35.43 x H 29.72 IN

W 220 x L 100 x H 75,5 CM
W 86.61 x L 39.37 x H 29.72 IN

Colour top



WHITE

BLACK

one-seat sofa



Sillón con perfil exclusivo de aluminio anodizado.
Uniones de los travesaños de fundición de aluminio.
Brazos opcionales. Tacos antideslizantes.
Textilene Batyline ignífugo.
Tornillería de acero inoxidable.

-
One-seat sofa with an exclusive anodized aluminium profile.
Joints in the crossbars made of cast aluminium.
Optional armrests.
Anti-slip feet.
Flame-retardant Textilene Batyline.
Screws made of stainless steel.

-
Materials:Aluminium / Batyline FR

Colour structure: Matt aluminium

-
W 70 X L 90 X H 76,2 X Hs 42 CM
W 27.55 X L 35.43 X H 30 X Hs 16.53 IN

Colour textile

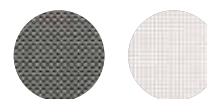

TITANIUM

WHITE

two-seat sofa



Sofá con perfil exclusivo de aluminio anodizado.
Uniones de los travesaños de fundición de aluminio.
Brazos opcionales.
Tacos antideslizantes.
Textilene Batyline ignífugo.
Tornillería de acero inoxidable.

-
Two-seat sofa with an exclusive anodized aluminium profile.
Joints in the crossbars made of cast aluminium.
Optional armrests.
Anti-slip feet.
Flame-retardant Textilene Batyline.
Screws made of stainless steel.

-
Materials:Aluminium / Batyline FR

Colour structure: Matt aluminium

-
W 140 X L 90 X H 76,2 X Hs 42 CM
W 55.11 X 35.43 X H 30 X Hs 16.53 IN

Colour textile

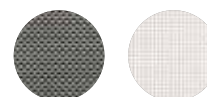

TITANIUM

WHITE

low table



Mesa baja de perfil exclusivo de aluminio anodizado.
Uniones de los travesaños de fundición de aluminio.
Tacos antideslizantes.
Textilene Batyline ignífugo.
Tornillería de acero inoxidable.

-
Low table with an exclusive anodized aluminium profile.
Joints in the crossbars made of cast aluminium.
Anti-slip feet.
Flame-retardant Textilene Batyline.
Screws made of stainless steel.

-
Materials:Aluminium / Batyline FR

Colour structure: Matt aluminium

-
W 100 X L 75 X H 41,7 CM
W 39.37 X 29.52 X 16.41 IN

Colour textile

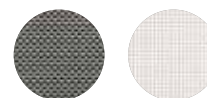

TITANIUM

WHITE

rectangular dining table



Mesa rectangular 180x90 para uso interior y exterior.
Estructura de aluminio anodizado pintado por pulverización y secado al horno, de 40 x 40 mm y 2 mm de grosor.
Sobre de 3 mm de grosor

-
Rectangular table 180x90 for indoor and outdoor use.
Powder coated anodized aluminium frame,
40 x 40mm and 2 mm thick.
Table top of 3 mm thickness.

-
Material: aluminio lacado
Material: lacquered aluminium

-
W90XL180X73.4 CM
W35.43XL70.87X28.90 IN

Colour

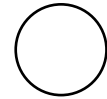

WHITE



BLACK



SAND

chair



Silla con brazos apilable para uso interior y exterior.
Estructura de aluminio anodizado pintado por pulverización y secado al horno.

-
Stackable armchair for indoor and outdoor use.
Powder coated anodized aluminium structure.

-
Material: aluminio lacado
Material: lacquered aluminium

-
L 54,5 x W 49 x H 80 x Hs 43 CM
L 21.4 x W 19.3 x H 31.5 x Hs 17 IN

Colour

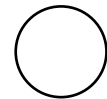

WHITE



BLACK



SAND

armchair



Sillón apilable para uso interior y exterior.
Estructura de aluminio anodizado pintado por pulverización y secado al horno.

-
Stackable armchair for indoor and outdoor use.
Powder coated anodized aluminium structure.

-
Material: aluminio lacado
Material: lacquered aluminium

-
L 54,5 x W 57 x H 80 x Hs 43 x Ha 62,5 CM
L 21.4 x W 22.4 x H 31.5 x Hs 17 x Ha 24.6 IN

Colour

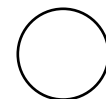

WHITE



BLACK



SAND

sofa



Sofá apilable para uso interior y exterior.
Estructura de aluminio anodizado pintado por pulverización y secado al horno.

- Stackable sofa for indoor and outdoor use.
Powder coated anodized aluminium structure.

- Material: aluminio lacado
Material: lacquered aluminium

- W 139 x L 59,7 x H 75,8 x Hs 35 x Ha 57 CM
W54.72xL 23.50 x H 29.84 x Hs13.78xHa22.44 IN

Colour

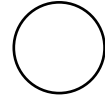

WHITE



BLACK



SAND

low armchair



Sillón bajo apilable para uso interior y exterior.
Estructura de aluminio anodizado pintado por pulverización y secado al horno.

- Stackable low armchair for indoor and outdoor use.
Powder coated anodized aluminium structure.

- Material: aluminio lacado
Material: lacquered aluminium

- W 69 L 59,7 H 75,8 Hs 35 Ha 57 CM
W 27.17 L 23.50 H 29.84 Hs 13.78 Ha 22.44 IN

Colour

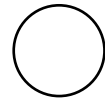

WHITE



BLACK



SAND

Coffee table



Mesa de centro apilable para uso interior y exterior.
Estructura de aluminio anodizado pintado por pulverización y secado al horno.

- Stackable coffee table for indoor and outdoor use.
Powder coated anodized aluminium.

- Material: aluminio lacado
Material: lacquered aluminium

- W 60 x L 101 x H 35,8 CM
W23.62xL39.76xH14.09 IN

Colour

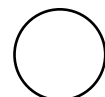

WHITE



BLACK



SAND

Sunlounger



Tumbona apilable para uso interior y exterior.
 Estructura de aluminio anodizado pintado por pulverización al horno, de 40 x 40 mm y 2 mm de grosor.
 Textilene de 1.170 gr/m2, termosoldado para mayor resistencia, y trama y urdimbre de doble hilo.
 Reclinable en 5 posiciones, incluyendo posición extraplana ideal para estar tumbado boca abajo.
 Respaldo con tope de seguridad.
 Ruedas en patas traseras y tacos antideslizantes en las delanteras y traseras.

-
 Stackable sunlounger for indoor and outdoor use.
 Powder coated anodized aluminium frame, 40 x 40 mm and 2 mm thick.
 Textilene 1170 gr/m2, thermal bonding to improve resistance, double linen weft and warp.
 Five-position reclining sunlounger, including flat position.
 Back with safety stopper.
 Wheels under back legs and non-slip end-plates under front and back legs.

-

Material: aluminio lacado
Material: lacquered aluminium

-
 W74.5XL506.1H35 CM
 W29.33XL81.14H13.78 IN

Colour

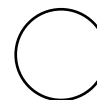

WHITE



BLACK



SAND

Ice cube table



Mesa auxiliar de 50 x 45 cm para uso interior y exterior.
 Estructura de aluminio anodizado pintado por pulverización al horno, de 40 x 40 mm y 2 mm de grosor.
 Sobre de 3 mm de grosor.
 Contiene cubitera de policarbonato transparente negro.

-
 Auxiliary table 50 x 45 cm for indoor and outdoor use.
 Powder coated anodized aluminium frame, 40 x 40 mm and 2 mm thick.
 Table top of 3 mm thickness.
 With ice bucket.

-

Material: aluminio lacado
Material: lacquered aluminium

-
 W50XL45H35.8 CM
 W19.69X17.72XH14.09 IN

Colour

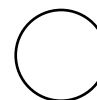

WHITE



BLACK



SAND

lucca 02



Sillón con perfil exclusivo de aluminio anodizado.
 Escuadras de unión y travesaño de fundición de aluminio.
 Textilene Batyline ignífugo.
 Tornillería de acero inoxidable.
 Tacos antideslizantes.

-
 Armchair with exclusive anodized aluminium profile.
 Joining brackets and crossbar made of cast aluminium.
 Flame-retardant
 Textilene Batyline.
 Screws made of stainless steel.
 Anti-slip feet.

-
Materials: Aluminium / Batyline FR

Colour structure: Matt aluminium

-
 W 62,5 x L 65 x H 94 x Hs 47 x Ha 67 CM
 w 24.60 x L 25.59 X H 37 X Hs 18.50 x Ha 26.37 IN

Colour textile

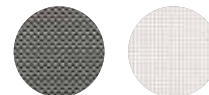

TITANIUM

WHITE

lucca l7



Tumbona con brazos.
 Perfiles exclusivos de aluminio anodizado.
 Uniones de aluminio. Travesaño de fundición de aluminio.
 Tornillería de acero inoxidable.
 Tacos antideslizantes.
 Textilene Batyline ignífugo.

-
 Sunlounger with armrests.
 Exclusive anodized aluminium profiles.
 Joints made of aluminium. Crossbar made of cast aluminium.
 Screws made of stainless steel.
 Anti-slip feet.
 Flame-retardant.
 Textilene Batyline.

-
Materials: Aluminium / Batyline FR

Colour structure: Matt aluminium

-
 W 62,2 x L 170,5 x H 36,5-94 x Ha 47,5 CM
 W 24.48 X L 67.12 X H 14.37-37 x Ha 18.7 IN

Colour textile



TITANIUM

WHITE

lucca l5



Tumbona corta con brazos.
 Perfiles exclusivos de aluminio anodizado.
 Uniones y travesaño en fundición de aluminio.
 Tornillería de acero inoxidable. Tacos antideslizantes.
 Textilene Batyline ignífugo.

-
 Short sunlounger with armrests.
 Exclusive anodized aluminium profiles.
 Joints and crossbar made of cast aluminium.
 Screws made of stainless steel. Anti-slip feet.
 Flame-retardant Textilene Batyline.

-
Materials: Aluminium / Batyline FR

Colour structure: Matt aluminium

-
 W 62,2 x L 97,8 x H 36,5-94 x Ha 47,5 CM
 W 24.48 X L 38.5 X H 14.37-37 x Ha 18.7 IN

Colour textile

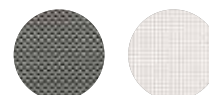

TITANIUM

WHITE

lucca 19



Reposapiés.
 Perfil exclusivo de aluminio anodizado.
 Uniones de aluminio.
 Tacos antideslizantes.
 Tornillería de acero inoxidable.
 Textilene Batyline ignífugo.

-
 Footrest.
 Exclusive anodized aluminium profile.
 Aluminium joints.
 Anti-slip feet.
 Screws made of stainless steel.
 Flame-retardant Textilene Batyline.

-
Materials:Aluminium / Batyline FR
Colour structure: Matt aluminium

-
 W 49,3 x L 65,2 x H 34 CM
 W 19.40 X L 25.66 X H 13.38 IN

Colour textile

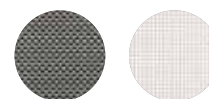

TITANIUM

WHITE

lucca s-32



Tumbona con inserción en brazos de madera tropical.
 Perfiles exclusivos de aluminio anodizado.
 Uniones de aluminio.
 Terminales de fundición de aluminio.
 Tornillería de acero inoxidable.
 Ruedas traseras de aluminio.
 Tacos antideslizantes.
 Textilene Batyline ignífugo.

-
 Sunlounger with a tropical wood insert in the armrests.
 Exclusive anodized aluminium profiles.
 Joints made of aluminium.
 Ends made of cast aluminium.
 Screws

-
Materials:Aluminium / Batyline FR
Colour structure: Matt aluminium

-
 W 70,9 x L 212,5-223,6 x H 48-99 CM
 W 27.91 x 83.66 - 88.03 x 18.89-38.97 IN

Colour textile



TITANIUM

WHITE

lucca s-36



Tumbona corta con inserción en brazos de madera tropical.
 Perfiles exclusivos de aluminio anodizado.
 Uniones de aluminio. Terminales de fundición de aluminio.
 Tornillería de acero inoxidable.
 Tacos antideslizantes en color negro.
 Textilene Batyline ignífugo.

-
 Short sunlounger with a tropical wood insert in the armrests.
 Exclusive anodized aluminium profiles.
 Joints made of aluminium. Ends made of cast aluminium.
 Screws made of stainless steel.
 Anti-slip feet in black colour.
 Flame-retardant Textilene Batyline.

-
Materials:Aluminium / Batyline FR
Colour structure: Matt aluminium

-
 W 70,9 x L 142-150,5 x H 50-98,5 CM
 W 27.91 X L 55.90-59.25 X H 19.68 - 38.77 IN

Colour textile

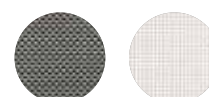

TITANIUM

WHITE

lucca 18



Carrito con ruedas de aluminio.
 Perfiles de aluminio anodizados.
 Sobre de HPL.
 Escuadras de unión de fundición de aluminio.
 Uniones de aluminio.
 Tacos antideslizantes.
 Tornillería de acero inoxidable.

-
 Cart with aluminium wheels.
 Anodized aluminium profiles.
 HPL top.
 Joining brackets made of cast aluminium.
 Anti-slip feet.
 Made of stainless steel.

-
Materials:Aluminium / HPL
Colour structure: Matt aluminium

-
 W 54 x L 77,7 x H 53 CM
 W 21.25 X L 30.59 X H 20.86 IN

Colour top

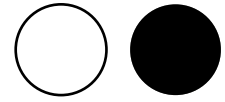

WHITE

BLACK

lucca 08



Mesa baja con estructura de perfil de aluminio anodizado y sobre de HPL.
 Uniones de aluminio.
 Tacos antideslizantes.
 Tornillería de acero inoxidable.

-
 Low table with anodized aluminium profile structure and HPL table top.
 Joints made of aluminium.
 Anti-slip feet.
 Screws made of stainless steel.

-
Materials:Aluminium / HPL
Colour structure: Matt aluminium

-
 W 90 X L 90 X H 36,3 CM
 W 35.43 X L 35.43 X H 14.29 IN

Colour top

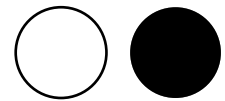

WHITE

BLACK

chair



Silla de perfiles exclusivos de aluminio anodizado.
Escuadras de unión y travesaño de fundición de aluminio.
Tornillería de acero inoxidable.
Textilene Batyline ignífugo.
Tacos antideslizantes.

-
Chair with a painted steel sled-base structure.
Flame-retardant and water-repellent polyester strip.
Anti-slip feet. Screws made of stainless steel.

-
Materials: Aluminium / Batyline FR
Colour structure: Matt aluminium

-
W 47,8 X L 57,4 X HS 47 X HA 85 CM
W 18.81 X L 22.59 HS 18.5 X HA 33.50 IN

Colour textile

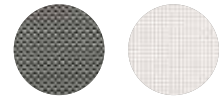

TITANIUM

WHITE

armchair



Silla con brazos de perfiles exclusivos de aluminio anodizado.
Brazos, escuadras y travesaño de fundición de aluminio.
Tornillería de acero inoxidable.
Textilene Batyline ignífugo.
Tacos antideslizantes.

-
Chair with armrests, with exclusive anodized aluminium profiles.
Armrests, brackets and crossbar made of cast aluminium.
Screws made of stainless steel.
Flame-retardant
Textilene Batyline.
Anti-slip feet.

-
Materials: Aluminium / Batyline FR
Colour structure: Matt aluminium

-
W 56,4 X L 57,4 X H 85 X HS 47 X HA 65,3 CM
W 22 X L 22.59 X H 33.5 X HS 18.5 HA 25.70 IN

Colour textile

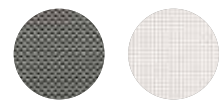

TITANIUM

WHITE

dom



Mesa con estructura de perfil de aluminio anodizado.
Sobre de HPL.
Tacos antideslizantes.
Tornillería de acero inoxidable.
Disponible en varias medidas.

-
Table with anodized aluminium profile.
HPL top.
Anti-slip feet.
Screws made of stainless steel.
Available in multiple sizes.

-
Materials: Aluminium / HPL
Colour structure: Matt aluminium

-
W 70 X L 70 X H 74 CM
W 27.55 X L 27.55 X H 29.13 IN

-
W 80 X L 80 X H 74 CM
W 31.49 X L 31.49 X H 29.13 IN

-
W 90 X L 90 X H 74 CM
W 35.43 X L 35.43 X H 29.13 IN

-
W 100 X L 100 X H 74 CM
W 39.37 X W 39.37 X H 29.13 IN

-
W 120 X L 80 X H 74 CM
W 47.24 X W 47.24 X H 29.13 IN

-
W 180 X L 90 X H 74 CM
W 70.86 X W 35.43 X H 29.13 IN

Colour top

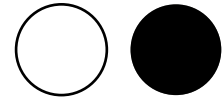

WHITE

BLACK



WASHED
WOOD

ASHEN
OAK

domino



Mesa de perfil de aluminio anodizado.
Sobre de HPL.
Tacos antideslizantes.
Tornillería de acero inoxidable.
Disponible en varias medidas.

-
Table with anodized aluminium profile.
HPL top. Anti-slip feet.
Screws made of stainless steel.
Available in multiple sizes.

-
Materials: Aluminium / HPL
Colour structure: Matt aluminium

-
W 90 X L 90 X H 74 CM
W 35.43 X L 35.43 X H 29.13 IN

-
W 100 X L 100 X H 74 CM
W 39.37 X W 39.37 X H 29.13 IN

-
W 100 X L 200 X H 74 CM
W 39.37 X W 78.74 X H 29.13 IN

-
W 100 X L 240 X H 74 CM
W 39.37 X W 94.48 X H 29.13 IN

Colour top



WHITE

BLACK



WASHED
WOOD

ASHEN
OAK

pool bed



Tumbona.
Perfiles exclusivos de aluminio anodizado.
Uniones de aluminio.
Tacos apiladores y antideslizantes.
Tornillería de acero inoxidable.
Textilene Batyline ignífugo.

-
Pool bed.
Exclusive anodized aluminium profiles.
Joints made of aluminium.
Stacking and anti-slip feet.
Screws made of stainless steel.
Flame-retardant Textilene Batyline.

-
Materials: Aluminium / Batyline FR
Colour structure: Matt aluminium

-
W 63,2 X L 221,4 X H 41-91,5 CM
W 24.88 x L 87.16 X H 16.14 - 36.02 IN

Colour textile

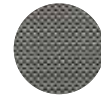

TITANIUM



WHITE

low table



Mesa baja con estructura de perfil de aluminio anodizado y sobre de HPL.
Uniones de aluminio.
Tacos antideslizantes.
Tornillería de acero inoxidable.

-
Low table with anodized aluminium profile structure and HPL table top.
Joints made of aluminium.
Anti-slip feet.
Screws made of stainless steel.

-
Materials: Aluminium / HPL
Colour structure: Matt aluminium

-
W45xL45xH37cm
W17.7xL17.7xH14.5

table



Mesa de pie central compuesta por cuatro patas de perfil de aluminio anodizado.
 Sobre de HPL.
 Base de mesa de perfil macizo de aluminio anodizado.
 Tornillería de acero inoxidable.
 Pies de acero inoxidable regulables en altura e inclinación.

-
 Pedestal base table with four legs with an anodized aluminium profile.
 HPL top.
 Solid profile table base made of anodized aluminium.
 Screws made of stainless steel.
 Stainless steel feet adjustable in height and tilt.

-
Materials: Aluminium / HPL
Colour structure: Matt aluminium

-
 Ø80 X H 74 CM
 Ø31.49 X H 29.13 IN

-
 Ø90 X H 74 CM
 Ø35.43 X H 29.13 IN

-
 Ø100 X H 74 CM
 Ø39.37 X H 29.13 IN

Colour top

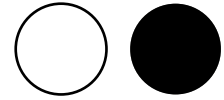

WHITE

BLACK



WASHED
WOOD

ASHEN
OAK

armchair



Sillón aluminio anodizado.
Asiento y respaldo en ratán sintético tejido a mano.
Perfiles y uniones de aluminio.
Tornillería de acero inoxidable.
Tacos antideslizantes.

-
Anodized aluminium armchair.
Seat and back support in hand woven synthetic rattan.
Profiles and joints made of aluminium.
Screws made of stainless steel.
Anti-slip feet.

-
Materials: Aluminium / syntethic rattan
Colour structure: Shiny aluminium

-
W 55 x L 62 x H 77 x Hs 46 CM
W 21.65 X L 24.40 X Hs 30.31 X 18.11 IN

Colour textile



BURGUNDY

IVORY



GREY

armchair



Silla con brazos para uso interior y exterior.
Fabricada en aluminio fundido, pulido y anodizado,
montado con tornillos de acero inoxidable.
Apilable.

100% reciclable según los estándares internacionales
de calidad de productos de bajas emisiones.

-

Armchair for indoor and outdoor use.
Seat and back made of anodized and polished aluminum,
mounted with stainless steel screws.

Stackable.

It's 100% recyclable according to International standards
of low emission products.

-

Materials: Aluminum

-

W 56,1 x L 56,4 x H 77,7 x Hs 43,8 x Ha 68,4 CM

W 22.09 x L 22.20 x H 30.59 x Hs 17.24 x Ha 26.93 IN

parís by jorge pensi

mesa parís 4



Mesa París 4

Pie central para uso interior y exterior de fundición de aluminio acabado con un pulido impecable.

Base con cuatro pies.

Tablero de Inox marino.

-

Pedestal base for indoor and outdoor use, made of cast aluminum finished with an impeccable polish.

Base with four feet.

Top inox

-

Materials: aluminum / top inox

-

W 81 x L 81 x H 70 CM

W 31.89 x L 31.89 x H 27.56 IN

ø 60, 70, 60x60, 70x70

parís alta



Pie central alto para uso interior y exterior, de fundición de aluminio acabado con un pulido impecable.

Base con cuatro pies.

Tablero de Inox marino.

-

High pedestal base for indoor and outdoor use, made of a cast aluminum finished with an impeccable polish.

Base with four feet.

Top inox

-

Materials: aluminum / top inox

-

W 59 x L 59 x H 107 CM

W 23.23 x L 23.23 x H 42.13IN

ø 60

parís 5



Pie central para uso interior y exterior, de fundición de aluminio acabado con un pulido impecable.

Base con cinco pies.

Tablero de Inox marino.

-

Pedestal base for indoor and outdoor use, made of a cast aluminum finished with an impeccable polish.

Base with five feet.

Top inox

-

Materials: aluminum / top inox

-

W 81 x L 81 x H 70 CM

W 31.89 x L 31.89 x H 27.56 IN

ø 80, 90, 105,80x80, 90x90



info@arqmat.com
www.arqmat.com