

## 4" Smart Control Panel(in-wall) SPEC

<b>Ver.</b>	<b>Description</b>	<b>Creator</b>	<b>Date</b>
V1.1	First edition	Engineer Department	2021-11-25

# Contents

Chapter 1 Product presentations .....	3
1.1 Appearance .....	3
Chapter 2 Product Specifications .....	4
RK3308B Quad core Cortex-A35 .....	4
Chapter 3 Ports and Specifications .....	5
3.1 Interface and ports .....	6
3.2 Specifications .....	7
Chapter 4 Installation instructions .....	8
4.1 Installation drawings .....	9
4.2 Wires connection drawing .....	10
Chapter 5 Operation guideline .....	11-19
5.1 Safety Notes***** .....	11
5.2 Operation guideline .....	11-19

# Chapter 1 Product presentation

## 1.1 Appearance



## 1.1 Main Features

- Compatible with the U.S. standard wall boxes, simple in wall installation.
- 4-inch HD LCD, TFT, multi touch screen, Auto light sensor.
- ZigBee gateway function, APP remote control.
- Control the lights, curtains, air conditioners, and all other Smart home devices. Configure Smart home scenes in the APP, turn on the scene mode with one touch on the screen.

## Chapter 2 Product Specifications

Specifications			
<b>CPU</b>	RK3308B Quad core Cortex-A35	<b>OS</b>	Linux 4.4.143
<b>RAM</b>	128MB	<b>Screen</b>	4 inch 480*800 Multi-touch
<b>ROM</b>	128MB	<b>Bluetooth</b>	BLE4.2 Single point
<b>Ethernet</b>	N/A	<b>RS485</b>	N/A
<b>WiFi</b>	802.11b/g/n150Mbps 2.4GHz	<b>Zigbee</b>	802.15.4 PHY/MAC Zigbee network protocol stack
Functions			
<b>Voice Wake-up</b>	Does not support voice wake-up.		
<b>Relays</b>	Built in 3 relays which can connect and control 3 gang switches.		
<b>Music play</b>	Built in 1W Mono speaker, Support custom local music source play, online music sources optional.		
<b>Light sensor</b>	Automatically adjust the screen brightness according to surroundings.		
<b>One Smart Control Panel could control all your smart switches, smart</b>			

**plugs, lights, air conditioners, curtains, locks, security cameras, smart sensors, up to 100+ ZigBee sub devices.**

# Chapter 3 Ports and Specifications

## 3.1 Interface and ports

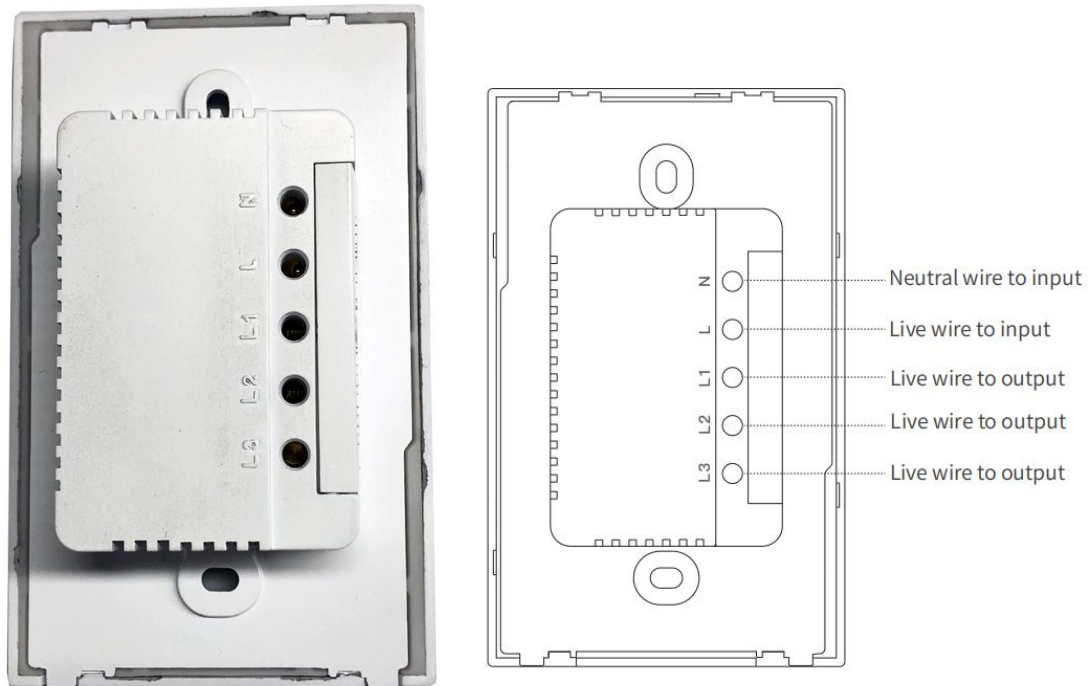

1. L & N - Power the panel by live wire and neutral wire
2. L1 - Live wire to output
3. L2 - Live wire to output
4. L3 - Live wire to output

## 3.2 Specifications

Item	Specifications
Power	Input: 100-240VAC 50/60HZ 6A Max Output: 100-240VAC 50/60HZ 2A/Gang 6A/Total Max
Wireless Protocols	Wi-Fi, Bluetooth, Zigbee
Working Temperature	0°C to +40°C
Working Humidity	5% to 90%RH(Non-condensing)
Product dimensions	120x74x11mm (without the base   outside the wall ) 120x74x37mm (with the base) 70x48x26mm (back base dimension) Bolt hole spacing 83mm
Net weight	About 186g

## **Chapter 4 Installation instructions**

- **Turn off the main power in the electricity box and confirm the live wire is not alive with a test pencil.**
- **Remove the base of the Smart Switch and install it in the wall box (as shown in the pictures following).**
- **Check the wires and make sure the wires are in good contact with the terminals and no exposed copper wires.**
- **Fasten the base to the wall box with mounting screws and fix the Smart Switch back to the base.**
- **Note that the screws should not be fixed too tight during installation in case any deformation or damage to the screen and hardware.**
- **If your smart panel is not flat after installation, do not press the screen violently, please check the wall box and the base installation at first.**



## 4.1 Installation drawings

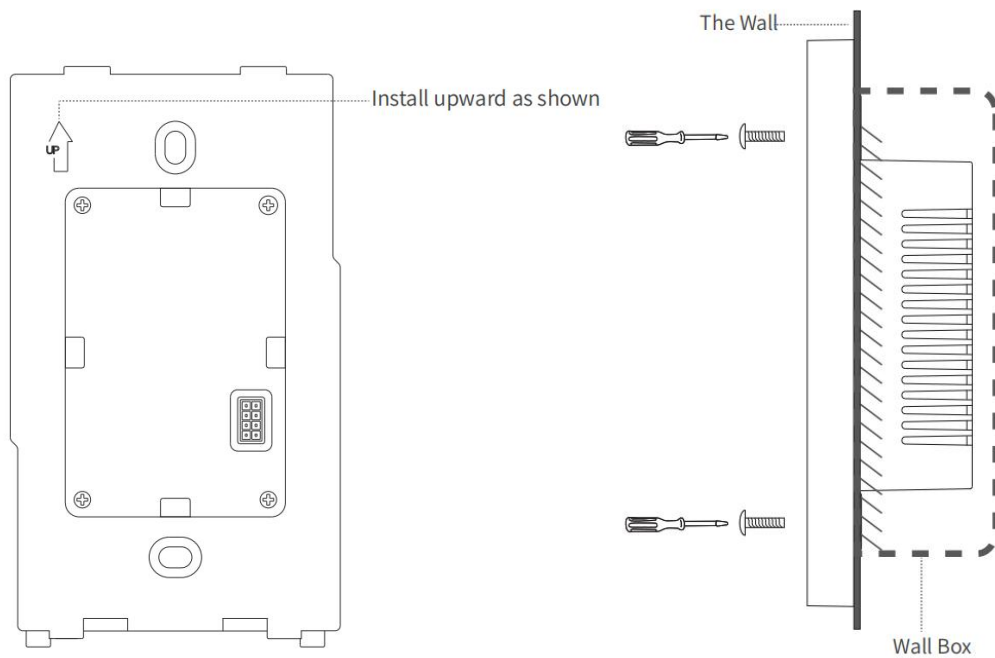
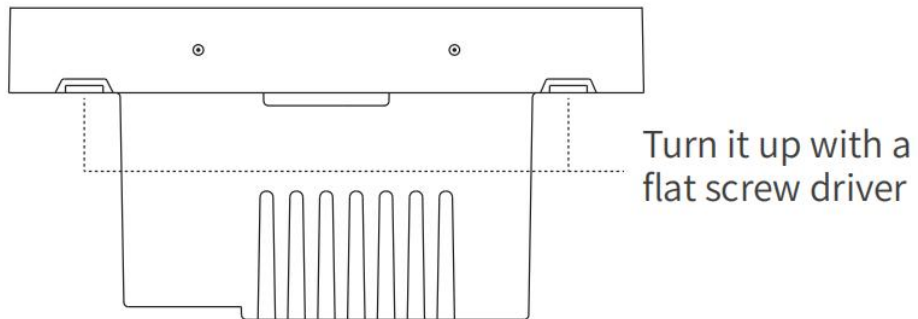

**Depth of the wall box should be more than 50mm.**

## 4.2 Wires connection drawing

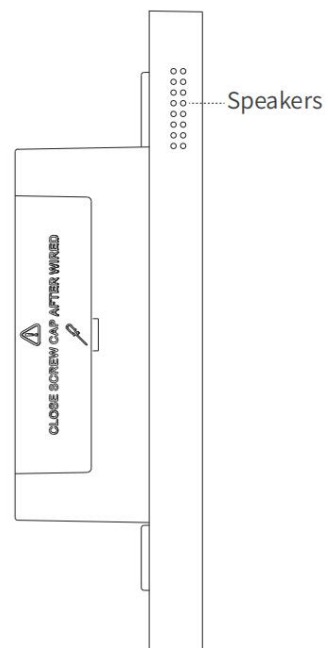
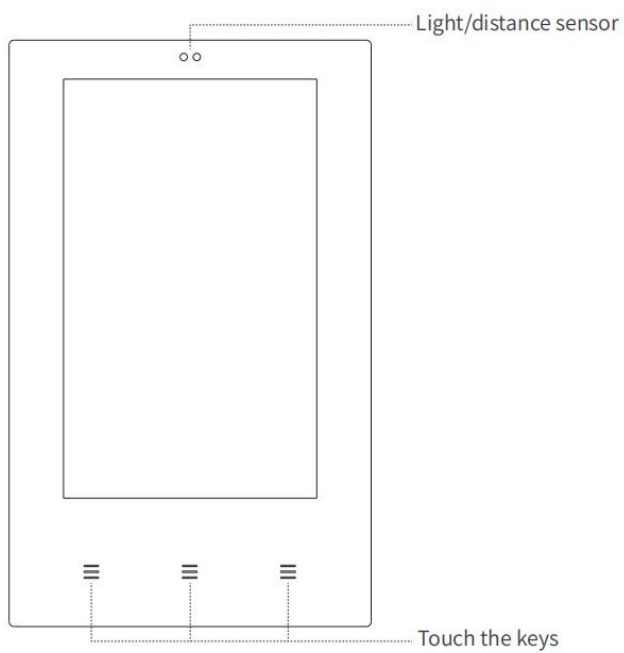
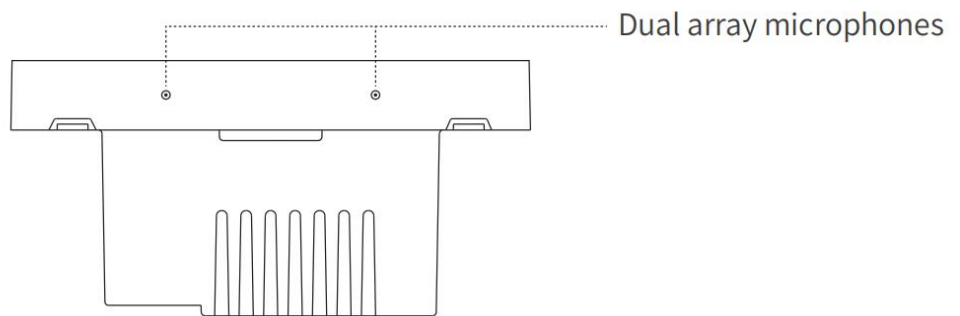
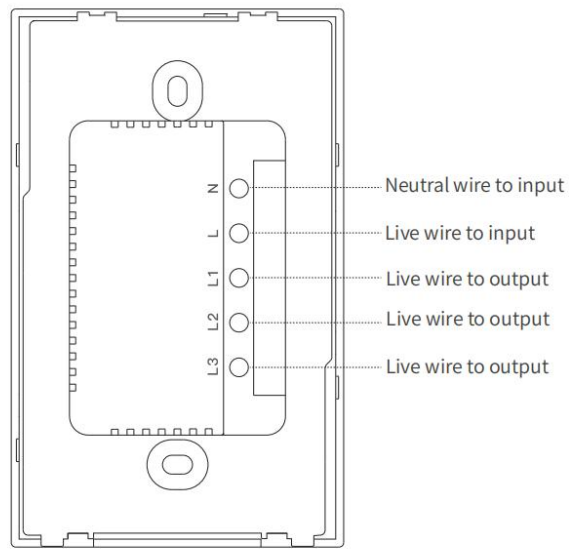

# Chapter 5 Operation guideline

## 5.1 Safety Notes\*\*\*\*\*

- The product must be installed by professional electricians.
- Turn off the main power in the electricity box and confirm the live wire is not alive with a test pencil.
- The product should be kept away from fire and water during installation and use.
- The product can not be used in moisture circumstances such as bathroom.
- Please note the product does not support POE power supply. Do not connect PoE wire to this product which would cause damage to the product.

## 5.2 Operation guideline



**\*This operation guideline is based on Tuya ZigBee, Tuya App, Tuya cloud platform and Smatek P6EL firmware. If any other platforms or firmware, please follow their operation guidelines.**

(1) The product will be turned on once you connect it to the power supply. The product will get to the network settings

when you start it in the first time. You can also get into the network settings from the select menu by dropping down from the top of the LCD screen.

(2) There are two options in the network settings. You can select wireless connection or wire connection. There will be a QR code showing on the screen after the network connection is done.



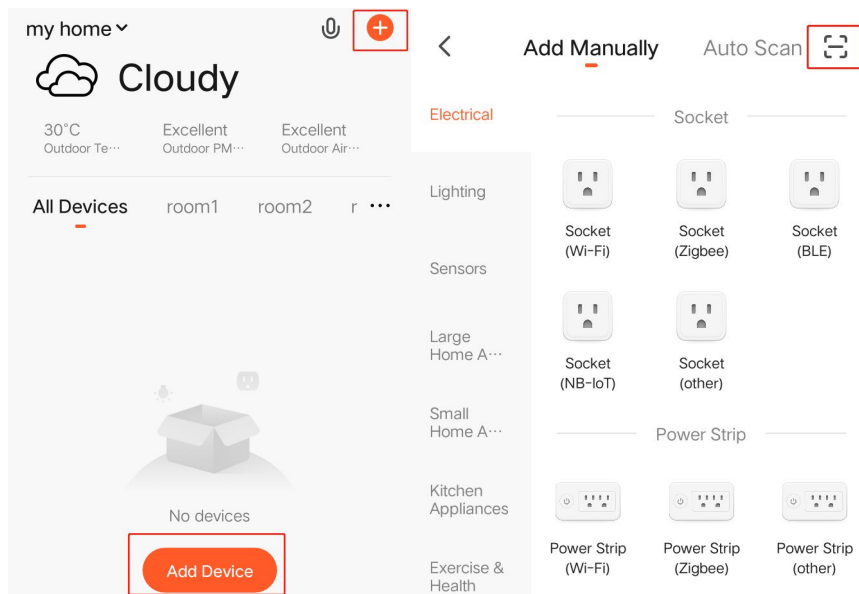

(3) Start the Tuya App in your smart phone, select the “” at top right corner in the App home page, and then select the “” at top right corner in the App page.

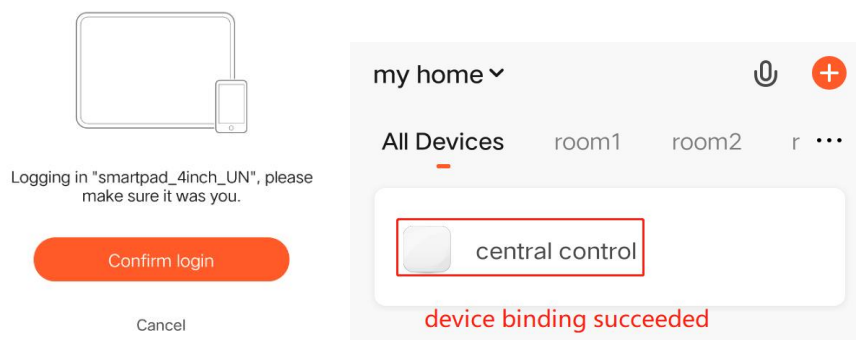

(4) Scan the QR code on the screen of the product to add it into the Tuya App.



(5) Get into the product interface in the Tuya App, you will see the gateway and switch icons like  and . Click the switch icon to control 3 local switches (load of each switch should be no more than 200W). It means the switch is off when the icon is in grey, and the switch is on when it is in blue.

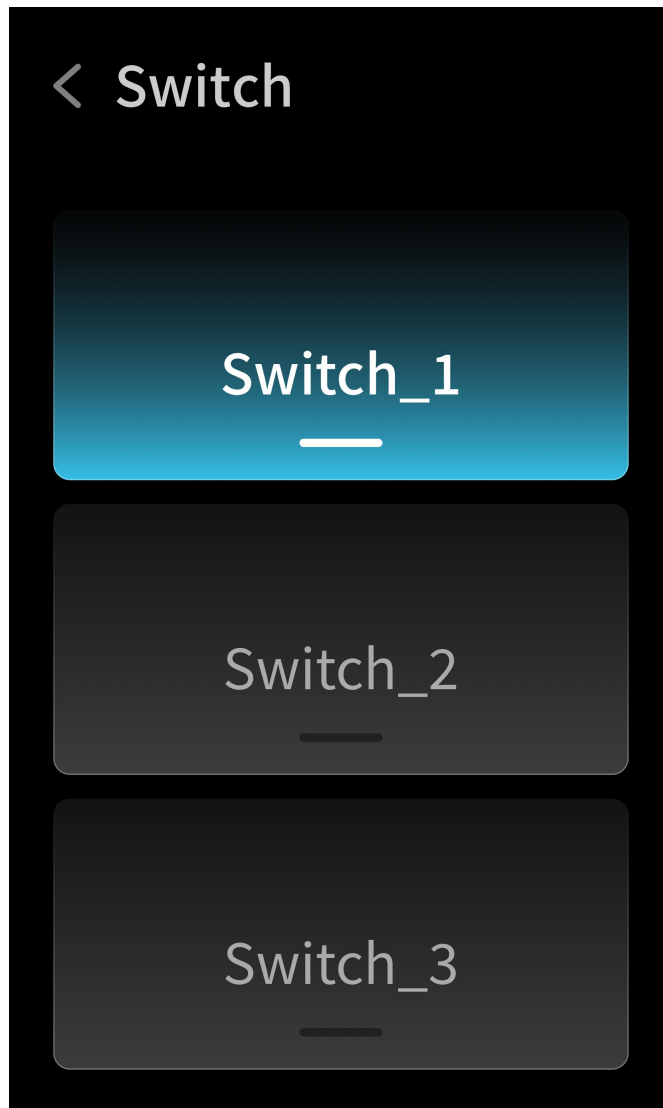

**Long press switch 1 or switch 2 or switch 3 to change the name of the switch.**

(6) Click the gateway icon to add ZigBee sub devices.

**Make sure the ZigBee sub devices are in the set-up mode.**

**The gateway will search and add the sub devices**

**automatically. You can follow the user manual of the sub**

**devices to make sure it is in set-up mode. (Usually it is long**

**press the power button or the reset button in 5s, then the LED indication light will flickering which means it is in the set-up mode.)**

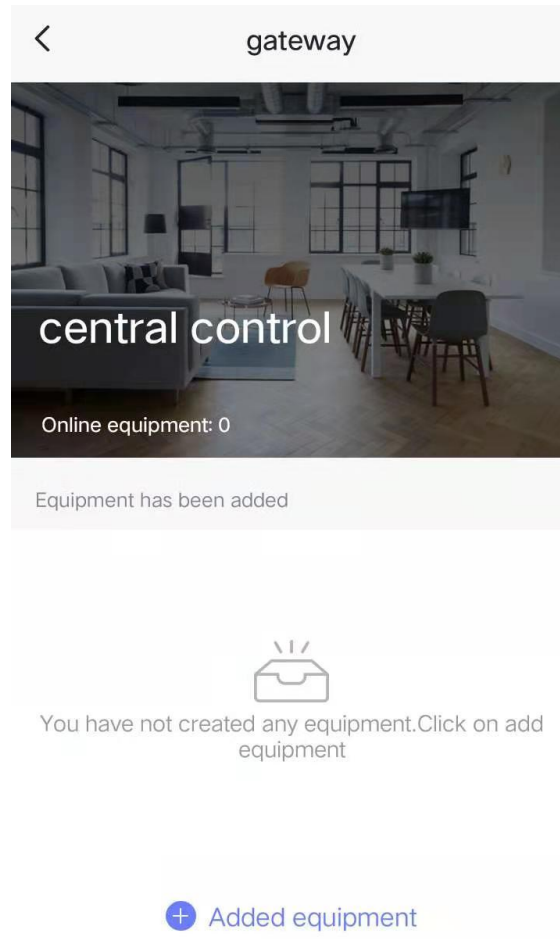

**You will see the following pictures in the Tuya App when you are adding sub devices to the gateway. Make sure the sub devices are in the set-up mode and the LED indication light is flickering.**

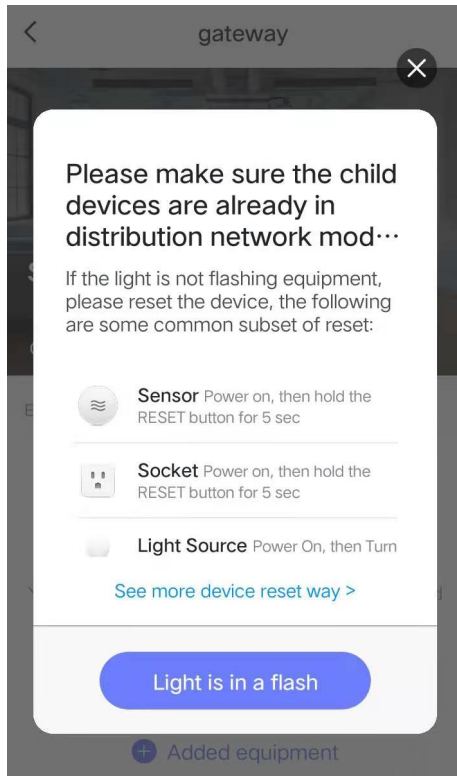

(7) Click the finish button on the App after you add the sub device successfully. For example (3 switches panel) as the following.



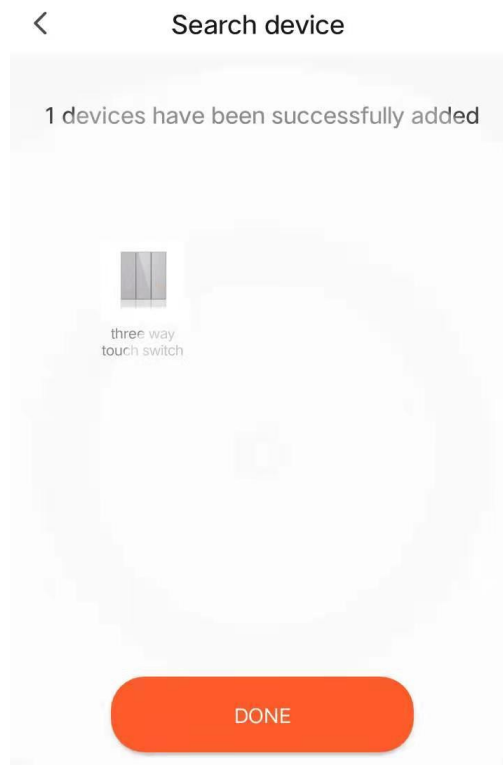

(8) You could change the name of the sub devices after they are added to the gateway successfully.

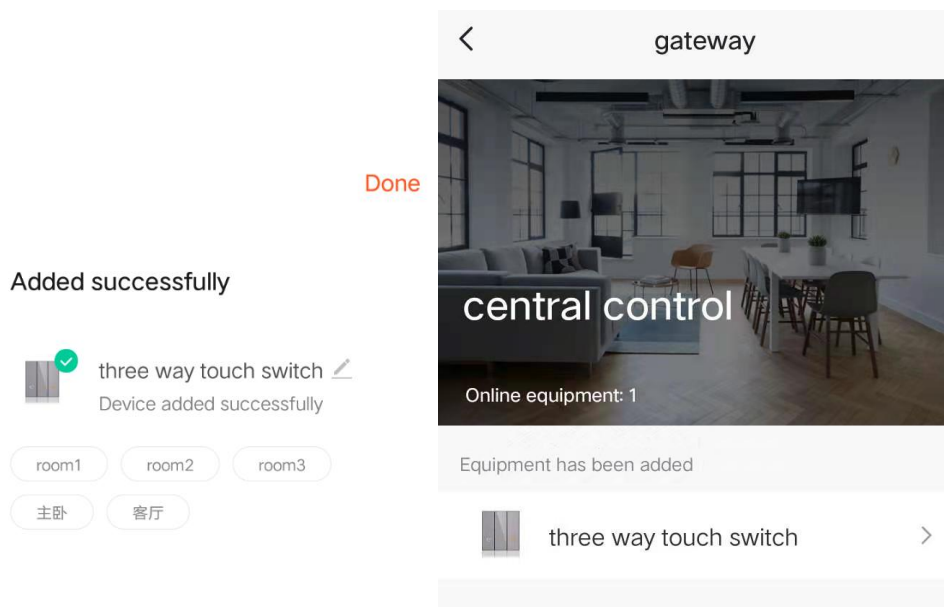

(9) You could change the device type by getting into the

device interface in the App. It means the switch is off when it is in grey, and the switch is on when it is in green. You could also set up timers(Schedule) for the switches to realize the automation control.



**(10) If you want to add your devices faster,click the “ + ” on App, find devices lists and add corresponding devices manually,finally drop down the list on panel and click “sync” to stay sync with App.**

If there is any questions when you add some other sub devices, please contact us for support.

