

SYNCA

USER MANUAL

**Circ plus
Compact massage chair**

MR360

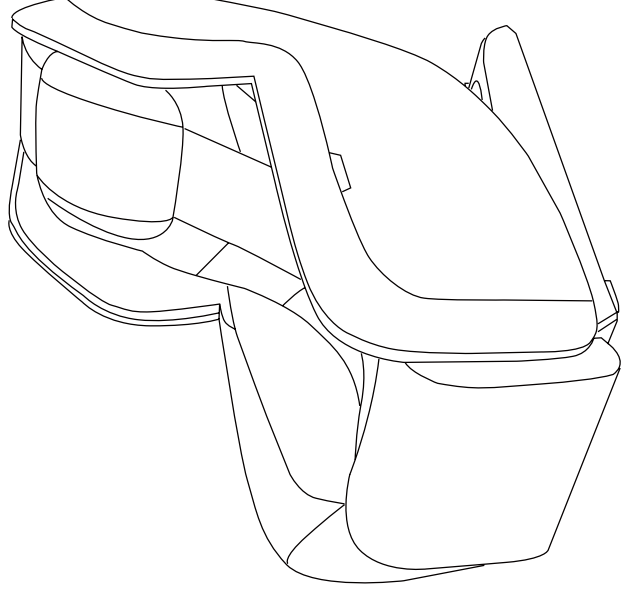

IMPORTANT SAFETY INSTRUCTIONS

Read all instructions before using (this appliance).

DANGER – To reduce the risk of electric shock:

- 1) Always unplug this appliance from the electrical outlet immediately after using and before cleaning.

WARNING – To reduce the risk of burns, fire, electric shock, or injury to persons:

- 1) An appliance should never be left unattended when plugged in. Unplug from outlet when not in use, and before putting on or taking off parts.
- 2) Do not operate under blanket or pillow. Excessive heating can occur and cause fire, electric shock, or injury to persons.
- 3) Close supervision is necessary when this appliance is used by, on, or near children, invalids, or disabled persons.
- 4) Use this appliance only for its intended use as described in this manual. Do not use attachments not recommended by the manufacturer.
- 5) Never operate this appliance if it has a damaged cord or plug, if it is not working properly, if it has been dropped or damaged, or dropped into water. Return the appliance to a service center for examination and repair.
- 6) Do not carry this appliance by supply cord or use cord as a handle.
- 7) Keep the cord away from heated surfaces.
- 8) Never operate the appliance with the air openings blocked. Keep the air openings free of lint, hair, and the like.
- 9) Never drop or insert any object into any opening.
- 10) Do not use outdoors.
- 11) Do not operate where aerosol (spray) products are being used or where oxygen is being administered.
- 12) To disconnect, turn all controls to the off position, then remove plug from outlet.
- 13) Do not use massager in close proximity to loose clothing or jewelry.
- 14) Keep long hair away from massager while in use.
- 15) Use heated surfaces carefully. May cause serious burns. Do not use over insensitive skin areas or in the presence of poor circulation. The unattended use of heat by children or incapacitated persons may be dangerous.

SAVE THESE INSTRUCTIONS

For use household only

CONTENTS

Thank you for purchasing this product.



Please read this user manual carefully before using to ensure proper installation and operation. Please keep this USER MANUAL properly for future reference.

SAFETY PRECAUTIONS	4
NAME AND FUNCTION OF EACH COMPONENT	6
External Structure	6
Internal Structure	6
Power Box	7
Controller	8
Controller Instructions	9
PRELIMINARY CHECKS	11
Position & Placement for Installation	11
Floor Protection	11
Surrounding Environment	12
Grounding	12
Installation Method	13
Moving the Massage Chair	14
Connecting to Power	14
Commissioning	15
Before Sitting in the Chair	15
After Use	15
CARE AND MAINTENANCE	16
TROUBLESHOOTING	17
TECHNICAL SPECIFICATIONS	18

SAFETY PRECAUTIONS

Safety Precautions

- ▶ Before using, please read the SAFETY PRECAUTIONS carefully to ensure correct operation of this appliance.
- ▶ Precautions and warnings listed below will help to ensure proper operation of this appliance.
- ▶ The classes of accidents caused by incorrect use are classified into WARNING and CAUTION. Read all WARNINGS and CAUTIONS below and follow all instructions within this manual.

	Improper operation may cause injury to users.
	Improper operation may cause injury to users or damage to product.
	NO Disassemble

Not suitable for below persons

We recommend that those with any of the following conditions should consult your physician before using.

	<ul style="list-style-type: none"> ◆ Those with pacemaker or electronic devices implanted in the body. ◆ Those undergoing treatment, especially those who are not feeling well. ◆ Those with malignant tumors, acute disease, heart disease or severe hypertension. ◆ Need to be supervised. ◆ Women who are pregnant or menstruating. ◆ Those with osteoporosis, distorted joints, dysfunction or recent fracture. ◆ Those with serious or injured skin conditions. ◆ Those with high fever. ◆ The appliance has a heated surface. Persons insensitive to heat must be careful when using the appliance. (Need to be supervised) ◆ This appliance is not intended for use by persons (including children) with reduced physical, sensory or mental capabilities, or lack of experience and knowledge, unless they have been given supervision or instruction concerning use of the appliance by a person responsible for their safety. ◆ This appliance can be used by children aged from 8 years and above and persons with reduced physical, sensory or mental capabilities or lack of experience and knowledge if they have been given supervision or instruction concerning use of the appliance in a safe way and understand the hazards involved.
---	---

Controller Precautions

	<ul style="list-style-type: none"> ◆ Do not operate the controller with wet hands or pull the controller wire by force. ◆ Do not spill water or other liquid into the controller to avoid fault. ◆ Do not lay heavy items on the controller.
---	---





Cautions Regarding the Power Connectors and Power Cord

	<ul style="list-style-type: none"> ◆ The appliance is only to be used with the power supply unit provided with the appliance. ◆ It must only be supplied at safety extra low voltage corresponding to the marking on the appliance. ◆ Do not use a wet hand to unplug the AC cord to avoid electric shock. ◆ Do not pull on the power cord, reach to the front end to unplug it. ◆ Do not squeeze the power cord by heavy objects. ◆ Do not damage, over bend, pull hard or twist the power cord. ◆ If the supply cord is damaged, it must be replaced by the manufacturer or its service agent or a similarly qualified person in order to avoid a hazard.
---	--

Best Circumstances

	<ul style="list-style-type: none"> ◆ Do not use this appliance where temperature is over 40 C. ◆ Do not use this appliance in moist or dusty environment. ◆ Unplug from outlet during thunder or lightning storms. ◆ Do not use outdoors. ◆ Please place the product on the flat level floor. ◆ Do not store near heat or open flame.
--	---

Best Practices for Safe Use

	<ul style="list-style-type: none"> ◆ Only for users weighs below 120kg. ◆ Do not use other therapeutic device together with this product. ◆ Use this product only for its intended use as described in this manual. ◆ Appliance should only be used by one person, do not use by two or more persons at the same time to avoid damage to the products. ◆ Do not use the product right after meal, it may cause discomfort. ◆ Remove the accessories from the arms and empty the pockets while use the massage services. ◆ Check the upholstery under the cushions and other spots, if any damages are present, do not use it and refer to a qualified service professional for servicing. ◆ If you feel any abnormal discomfort during the operation of this product, turn off the power immediately and do not use the product. ◆ Use the appliance for 20 minutes each time is highly recommended. ◆ Make sure there is no obstacles behind the chair and there is enough clearance before adjusting the backrest or footrest angle ◆ Make sure no other excessive load pressed on the backrest or footrest, keep children, pets or any other barrier away from the unit reclining backrest/ extending footrest to prevent any accidental injury. ◆ Please be seated properly while using the appliance to avoid injury to the user or damage to the appliance. ◆ Do not drag or push the chair or roll on its casters on wood floor or carpet to avoid damage.
	<ul style="list-style-type: none"> ◆ Never operate this product if it has damaged /exposed parts or power leakage. ◆ Do not stand on or stack heavy objects on the footrest. ◆ Children should be supervised to ensure that they do not play with the massage chair. ◆ Do not fall into sleep while the product is operating. ◆ Avoid using the product under the influence of alcohol. ◆ Do not put hands or foreign objects in the openings of the appliance to avoid injury to the user or damage to the appliance. ◆ If there is any smoke or unusual smell during operation, stop using immediately.
	<ul style="list-style-type: none"> ◆ Do not disassemble this product to avoid failure. ◆ Do not attempt to repair or dismantle the appliance without permission. ◆ Please contact authorized dealer or service agent.
	<ul style="list-style-type: none"> ◆ Pull out the power cord from the power strips before maintenance. ◆ Never plug in or pull out power cord with wet hand to avoid shock or injury. ◆ Pull out the power cord from the power strips after use. ◆ Unplug from outlet when the power supply is cut.

NAME AND FUNCTION OF EACH COMPONENT

External Structure

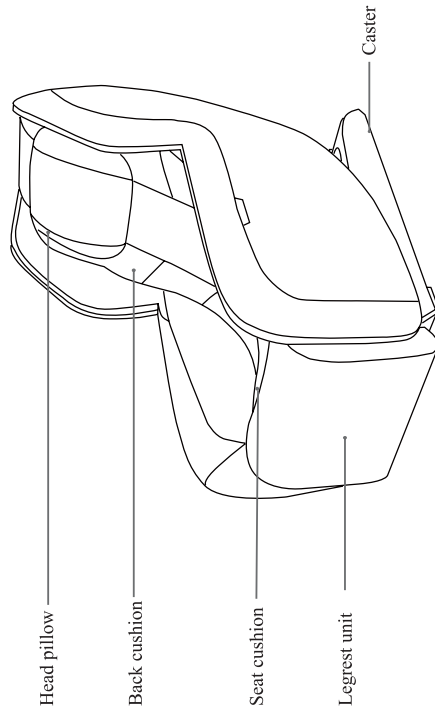

Internal Structure

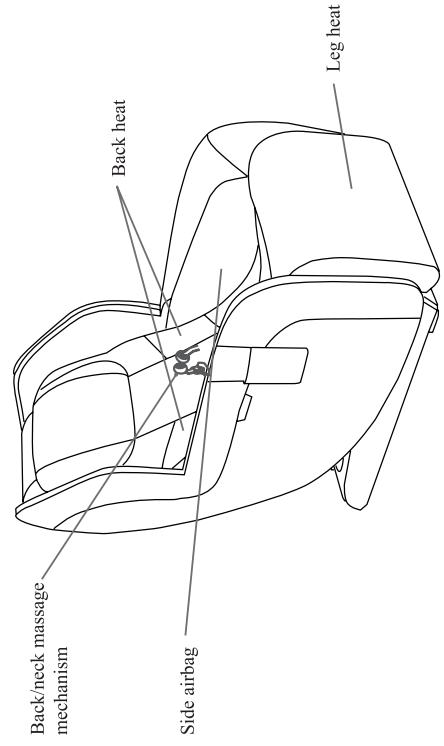

Power Box

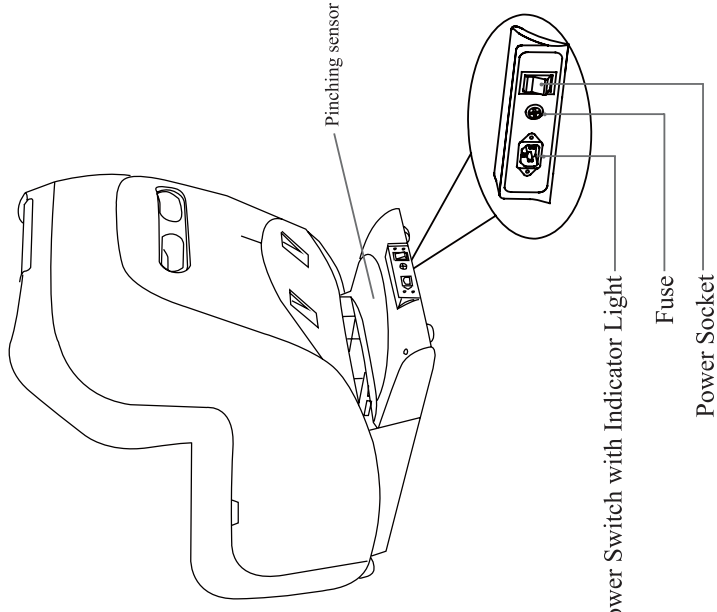

CAUTION







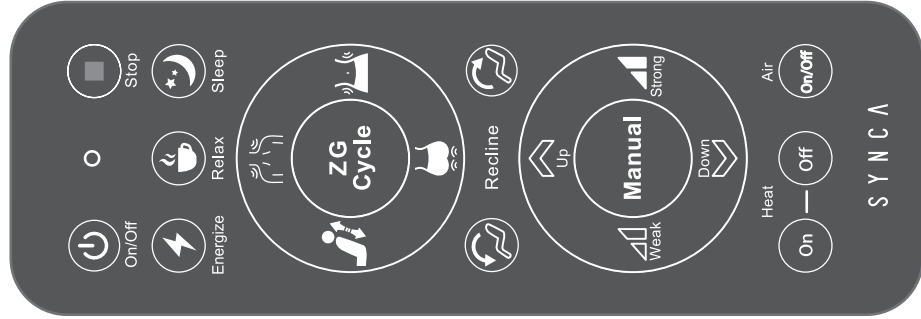

- ▶ Children should be supervised to ensure that they do not play with the chair or touch the power box.
- ▶ Always unplug the massage chair from the electrical outlet immediately after use
- ▶ Unplug from outlet during thunder or lightning storms, and before putting on or taking off parts.
- ▶ Turn off the power switch and unplug the massage chair from the electrical outlet while not in use to avoid children power on the massage chair accidentally.
- ▶ When not in use for a long period of time, we recommend that the chair be covered, the power cord be coiled and that the unit be placed in an environment free of dust and moisture.

NAME AND FUNCTION OF EACH COMPONENT

Controller



Controller Instructions

- 
Power On/Off
 ▶ Press this button to power on and recline the massage chair to massage position, you may choose the desired program to enjoy a massage; press this button again to turn off and restore the massage chair. Massage chair will be powered off automatically if there is no operation for 3 minutes in standby mode.
- 
Stop
 ▶ Press this button to stop all function during massage, press On/off button to restore the massage chair.
- 
Energize
 ▶ A Full body speedy kneading and tapping massage to energize the body.
- 
Relax
 ▶ A Full body slow kneading massage to relax the body.
- 
Sleep
 ▶ A Full body slow kneading and rocking to aid the sleep.
- 
Neck & Shoulder
 ▶ A focus massage to ease the pain and stiffness in the neck and shoulders.
- 
Waist
 ▶ A focus massage to ease the pain and tension in the waist.
- 
Buttock
 ▶ A focus massage to boost the blood circulation and ease the pain in the buttocks.
- 
Back Stretch
 ▶ A Combination of tapping, shiatsu and kneading massage covering from the shoulder to the buttock.

- 

ZG Cycle

 - ▶ A full body kneading, tapping and shiatsu massage at Zero Gravity position.
- 

Backrest Up

 - ▶ Press and hold to incline the backrest to the desired angle.
- 

Backrest Down

 - ▶ Press and hold to recline the backrest to the desired angle.
- 

Manual

 - ▶ Press this button to focus the massage to the current point, you may cycle through kneading, tapping, kneading and tapping manual massage techniques.
- 

Message Strength Weak

 - ▶ Press this button to decrease the mechanism massage strength
- 

Message Strength Strong

 - ▶ Press this button to increase the mechanism massage strength
- 

Massage Unit Up

 - ▶ When in manual mode or when the shoulder scanning is working (continuous beep beep sound), press and hold this button to move the rollers up.
- 

Massage Unit Down

 - ▶ When in manual mode or when the shoulder scanning is working (continuous beep beep sound), press and hold this button to move the rollers down.
- 

Heater On

 - ▶ Press this button to turn on the heating function.
- 

Heater Off

 - ▶ Press this button to turn off the heating function.
- 

Air On/Off

 - ▶ Press this button to turn on the air pressure massage function, press this button again to turn off the air pressure massage function.

Attention:
There is prompt tone broadcast with each operation to ensure a reassuring use.

Position & Placement for Installation

Clearance space for the massage chair:

- ▶ Ensure there is an adequate clearance for the installation. It needs 15cm clearance for the reclining of the backrest; It needs 15cm clearance space for the legrest to raise.
- ▶ Keep it 1 meter away from the TV, radio or other audio/video appliance to avoid signal interference.

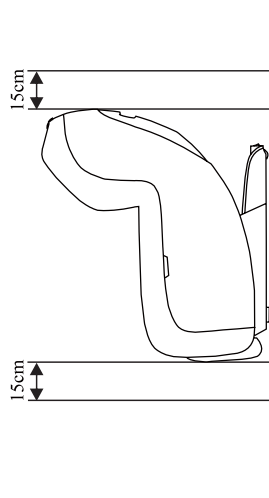

Floor Protection

- ▶ We recommend to place a piece of carpet or soft mat underneath it to avoid damaging the floor.

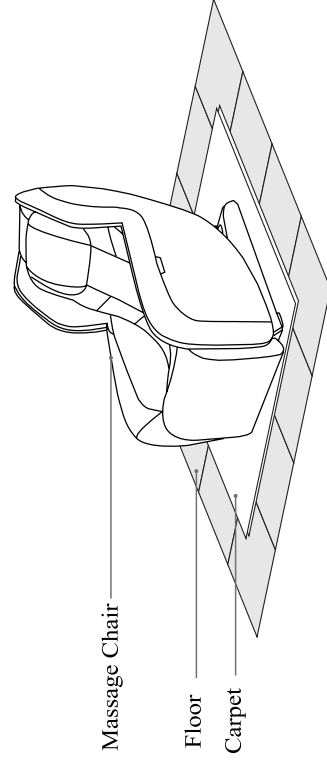

PRELIMINARY CHECKS

Surrounding Environment

Do not use the massage chair in high moisture environment such as near swimming pool or bathroom to prevent electric shock accident.



Please keep the massage chair away from heated surfaces to prevent fire hazard or damage to the product.



Grounding

This product must be grounded, the plug must be plugged into an appropriate 3-wire grounded outlet that is properly installed and grounded in accordance with all local codes and ordinances to reduce risk of electrical shock.



Installation Method (Have two or more people move the chair.)

Step 1

- ▶ Unpack the box, take the massage chair and power cord out of the box, check the packing list and verify that all components are included.

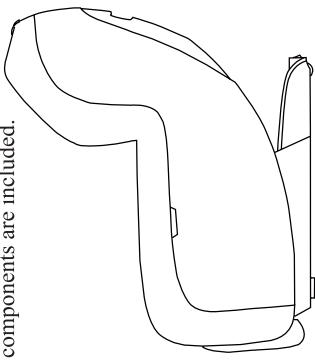

Step 2

- ▶ Plug the power cord into the chair and connect to the power outlet, turn on the main power switch, you are set to go.

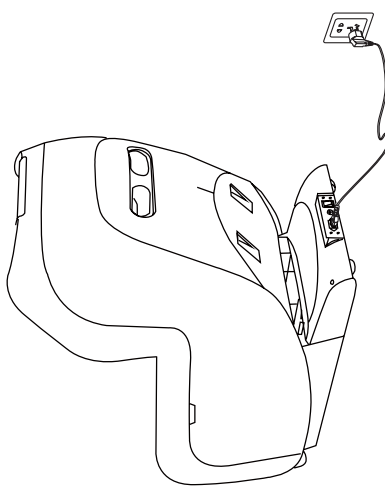

CAUTION

- ▶ Straighten the power cord while in use to avoid tangle or damage.

Moving the Massage Chair

- ▶ Roll the chair on its casters to the desired location.
- ▶ Incline the backrest to upright position.
- ▶ Turn off the power switch and unplug the appliance from the electrical outlet.
- ▶ Using two people, push down on the backrest and lift up on the front side by grabbing the moving Holder located to the front bottom of the armrest, roll the chair on its casters to the desired location (check the sketch for reference).



⚠ CAUTION

- ▶ Do not move the chair when there is user inside.
- ▶ To carry this product, do not lift by the footrest or armrest, hold the chassis and steady the backrest (have 2 or more people to carry the product).

Connecting to Power

- ▶ Connect this appliance to a 3-wire properly grounded outlet.
- ▶ Turn on the main power switch by the right hand side of the massage chair.

⚠ CAUTION

- ▶ Please verify that there is no damage to the supply cord before switching on the massage chair.
- ▶ Please verify that the main power switch is turned off before connecting to power.

Commissioning

- ▶ Use the controller to recline the backrest to its lowest position and the legrest to its top position, the legrest to its top position, make sure there is enough clearance before commissioning.
- ▶ Return the backrest and legrest back to its default position after commissioning and turn off the power switch. To choose the massage program, please check the controller and Controller Instructions for reference.

Before Sitting in the Chair

- ▶ Ensure the legrest is in restored position before sitting on the massage chair.
- ▶ Ensure the massage chair is returned to its original position before sitting on it.
- ▶ If there is any part not in default position, please turn off the massage chair to allow it to restore.

⚠ CAUTION

- ▶ Do not take seat while the legrest is lifted.
- ▶ Do not put excessive load on the legrest to avoid damage.

After Use

- ▶ Always unplug the massage chair from the electrical outlet immediately after use.
- ▶ Put the Controller onto the holder.
- ▶ Turn off the power switch and unplug the massage chair from the electrical outlet while not in use to avoid children power on the massage chair accidentally.
- ▶ When not in use for a long period of time, we recommend that the chair be covered, the power cord be coiled and that the unit be placed in an environment free of dust and moisture.

Care Instructions

- ▶ To treat stains on back panel, armrest, legrest, plastic parts or air hose, spot clean with mild detergent foam, then wipe it with a dry cleaning cloth.
- ▶ To treat stains on controller, power box, spot clean with a dry cleaning cloth.
- ▶ To treat stains on back cushion or pillows, use a water-based upholstery cleaner only, wipe it with moist cloth, then air dry.
- ▶ To clean the legrest unit covers, remove it from the chair, hand wash with a mild detergent, then line dry.

WARNING

- ▶ Children shall not play with the appliance. Cleaning and user maintenance shall not be made by children without supervision.
- ▶ Pull out the power cord from the power strips before care and maintenance.
- ▶ To avoid electrical shock or injury, do not touch the power cord with wet hands.
- ▶ Make sure no detergent enters into the power box while cleaning.
- ▶ Do not use benzene, thinner or other solvents on your product; it may cause fading or damage to the product.
- ▶ Do not iron the upholstery.

Storage Methods

- ▶ Cover the product with a dust-free cloth to prevent collection of dust if not in use of a long period of time.

CAUTION

- ▶ Do not leave this product exposed to direct sunlight for long periods of time. This may cause fading or damage.

Warm Tips

- During daily use, please check for the following symptoms:
- ▶ Burnt smell.
 - ▶ Power flickers on and off when touching the charging cable.
 - ▶ The power cord is hot.
 - ▶ Other abnormal symptoms.

CAUTION

- ▶ Please stop using the product to avoid breakdowns or accidents if any above symptom exists.
- ▶ Switch off the power button and disconnect the plug, contact the local distributors or supplier for repair.
- ▶ All other servicing except above care and maintenance should be serviced by an authorized dealer or service center.

WARNING

- ▶ Pull out the power cord from the power strips before care and maintenance. To avoid electrical shock or injury, do not touch the power cord with wet hands. Do not try to dismantle or repair the product yourself; please send your massage chair to the authorized service center.

No.	Symptoms	Possible Causes	Possible Solutions
1	Noise is heard while in use	This sound is normal and comes from the air pump motor or other mechanical parts rubbing against the cloth cover	No need to take any measures
2	Massage Chair does not start	The power cord is not secured into the socket Power switch is off	Secure it into a well-functioned electrical outlet Turn on the switch
3	Backrest or legrest can not raise or recline	The fuse is blown Excessive load has been pressed on the backrest or legrest	Replace only with a fuse of same type and rating Reduce the load and try again

If problem remains, please contact the dealer for maintenance.

Important: Do not attempt to repair this product yourself, our company shall not be liable for the injury or damage caused by any servicing without authorization.

TECHNICAL SPECIFICATIONS

Name: Massage Chair

Model: MR360

Rated voltage: 100-240V~

Rated frequency:50-60Hz

Rated power: 140W

Safety design: Class I

Technical Description

This product is working under 433.99MHz frequency and scope of work is as follows: 433.99MHz

This product is 3 V lithium battery power supply, working through 20 button working mode.

The main parts as follows:

1. Lithium battery (CR2032)
2. RF module (BC48R2020)
3. Crystal (13.56MHz)

This device complies with Part 15 of the FCC Rules.

Operation is subject to the following two conditions:

- (1) this device may not cause harmful interference, and
- (2) this device must accept any interference received, including interference that may cause undesired operation.

Warning:

Changes or modifications to this unit not expressly approved by the party responsible for compliance could void the user authority to operate the equipment.

This equipment has been tested and found to comply with the limits for a Class B digital device, pursuant to Part 15 of the FCC Rules. These limits are designed to provide reasonable protection against harmful interference in a residential installation. This equipment generates, uses and can radiate radio frequency energy and, if not installed and used in accordance with the instructions, may cause harmful interference to radio communications.

However, there is no guarantee that interference will not occur in a particular installation. If this equipment does cause harmful interference to radio or television reception, which can be determined by turning the equipment off and on, the user is encouraged to try to correct the interference by one or more of the following measures:

- ◆ Reorient or relocate the receiving antenna.
- ◆ Increase the separation between the equipment and receiver.
- ◆ Connect the equipment into an outlet on a circuit different from that to which the receiver is needed.
- ◆ Consult the dealer or an experienced radio/TV technician for help.

This Transmitter must not be co-located or operating in conjunction with any other antenna or transmitter.