



Master Pursuit
By grower's choice

1000W HPS SYSTEM

Installation and Operating Instructions

MP-1000 HPS-240W (208V-277V) • MP-1000 HPS-277W (277V-347V)

**PLEASE READ
THESE INSTRUCTIONS
BEFORE USING
THE PRODUCT**

TECHNICAL SPECIFICATIONS:

Rated Main Voltage:	208V 240V 277V 347V
Input Current:	5.1A 4.4A 3.8A 3.0A
Input Frequency:	50/60 Hz
Power Factor:	>0.98
Relative humidity:	<70%
THD:	<10%
Required Lamp Voltage:	200V ~ 280V
Illumination Surface:	10' X 10'

State	Off-DB	On-DB	Off-Rem	On-Rem	Open	Short	HTP	LVP	HVP
Green	Off	Off	Flash	On	On	Off	On	Flash	Flash
Red	Flash	On	Off	Off	Flash	Strobo	On	Flash	On

INTRODUCTIONS:

Thank you for purchasing the Grower's Choice Master Pursuit 1000W HPS system. This manual describes the mounting and installing of the product and also describes how to use the product. Mounting and installing the fixture may only be executed by certified service personnel. Damage to the luminaire and lamps as a result of incorrect installations and use may revoke the warranty. Please read and understand this manual completely before using the product.



- Off-DB** =Ballast is switched off by dim button.
- On-DB** =Ballast is switched on by dim button.
- Off-Rem** =Ballast is switched off by remote.
- On-Rem** =Ballast is switched on by remote.
- Open** =Ballast is off because of an open contact or defect bulb
- Short** =Ballast is off because of short-circuit or defect bulb
- HTP** =Ballast is off because of High Temperature Protection (Ballast is too hot)
- LVP** =Ballast is off because of Low Voltage Protection
- HVP** =Ballast is off because of High Voltage Protection

- When both LED's are off, check fuse and power supply.
- Strobo is a very fast flash



SAFETY WARNINGS:

Grower's Choice Master Pursuit 1000W HPS System is special designed and tested pairing with Grower's Choice Master Pursuit HPS Lamps. Using other lamps in this system may cause harm to the system or the lamps and void warranty.

- Always adhere to the local rules and regulations when installing or using the fixture.
- Do not open the ballast or disassemble the fixture, it contains no service parts inside. Doing so will void the warranty.
- Wearing protective gloves is recommended during installation, servicing lamps and replacing reflectors.
- Always disconnect from the mains before performing any maintenance to the fixture.
- This fixture is designed and tested for damp indoor location only. Do not use in wet environment or outdoors.
- The fixture and lamps will get hot during operation. Do not touch while light is on. Keep this product away from children.
- Always allow at least 20 minutes for lamps to cool before handling.
- Keep power cord away from hot surface
- Do not use the fixture when either its lamp or power cord are damaged. Contact us immediately.
- Do not plug this system into a supply voltage other than what is instructed on the fixture.
- This product may cause interference to radio equipment and should not be installed near maritime safety communications equipment or other critical navigation systems operating between 0.45-30 MHz.
- Do not expose fixture to condensing humidity, heavy mist, fog or direct spray.
- Do not expose fixture to direct sunlight during use or other light that could heat up the fixture.
- Wearing protective glasses is highly recommended working under white light is on.

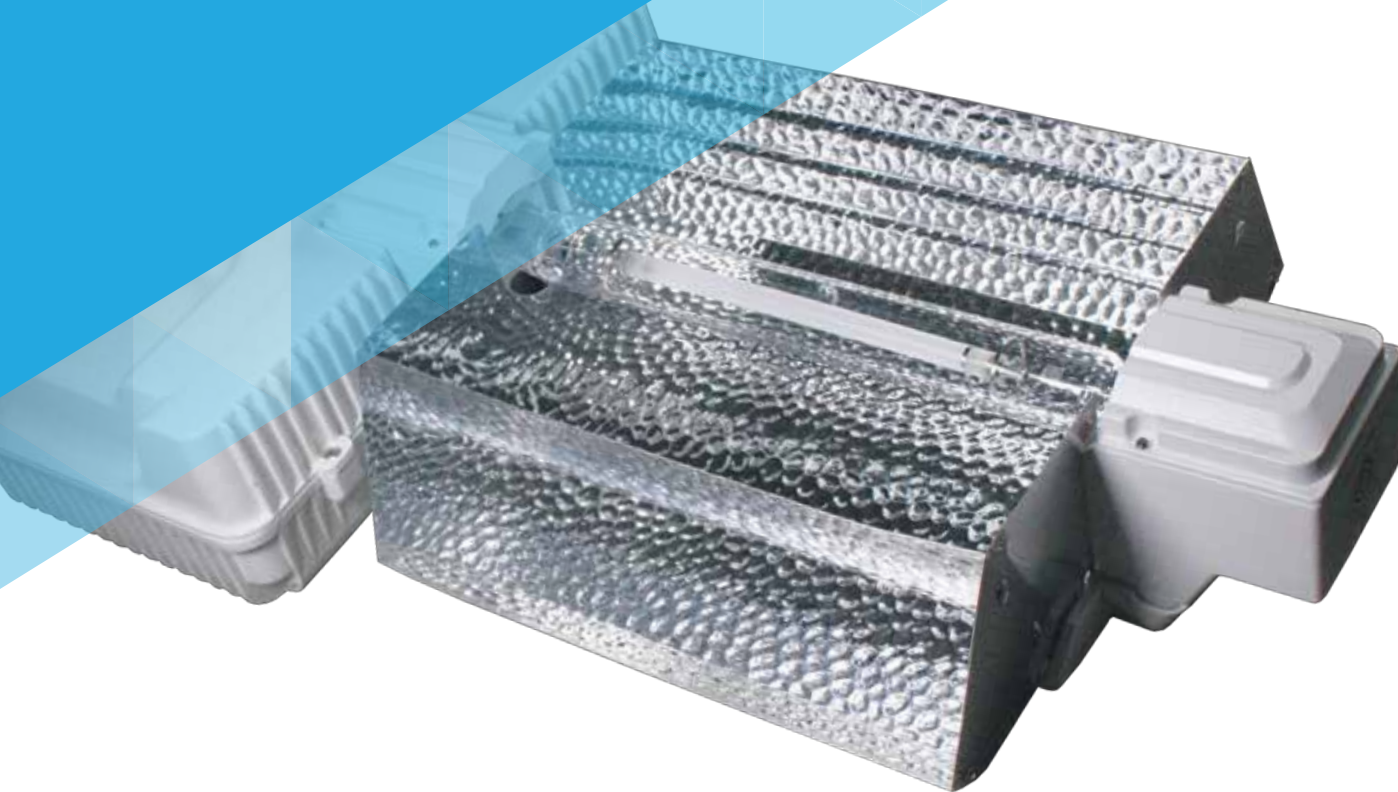

1000W Master Pursuit HPS Lamp

CONTENTS:

- Fixture with the one set of power cord attached.
- Master Pursuit HPS Lamps
- Gloves

Not Included:

- RJ cord
- Controller
- Hanging kit
- Protection glasses

INSTALLATION:



- Switch off mains power.
- Remove the system from the box along with all additional parts.
- Make sure the end wires are straight.
- Remove the lamp-holder covers.

- Using the gloves provided, carefully install the lamps.

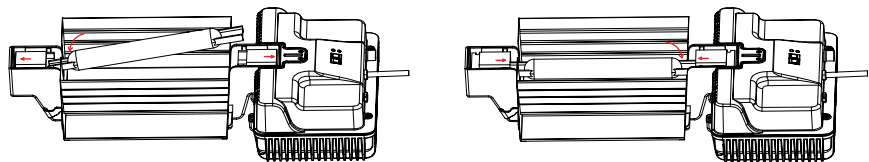

- Open the lamp holders by sliding them outward. Press the lamp in the fitting until the metal springs hold the lamp, with the glass vacuum seal pointed downward.

- Make sure the end wires are straight still.
- Close the lamp holders by sliding them inward.

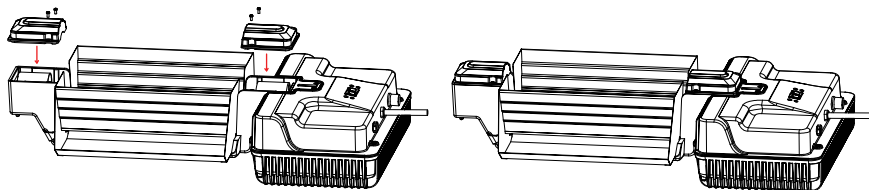

- Close the lamp covers.

- Replacement of the reflector.

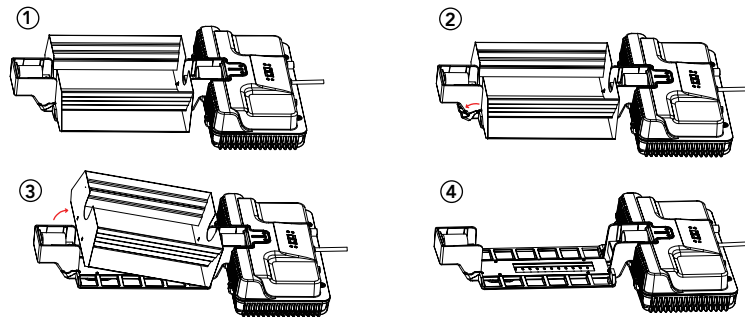

- Hang the fixture per light distribution plan: (different ways of hanging)

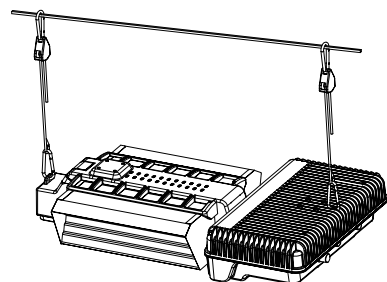
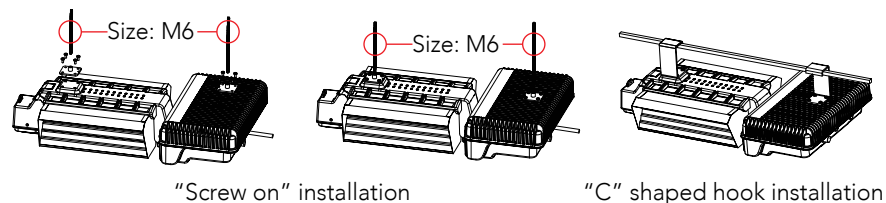

Intermediate sling installation

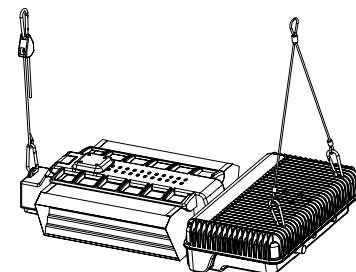

Sling installation

WARRANTY:

GROWER'S CHOICE warrants the mechanical and electronic components of their product to be free of defects in material and workmanship if used under normal operating conditions for a period of three (3) years from the original date of purchase. If the product shows any defects within this period and that defect is not due to user error or improper use, GROWER'S CHOICE shall, at its discretion, either replace or repair the product using suitable new or reconditioned products or parts. For HID lamps, the warranty period is one (1) year from the original date of purchase. GROWER'S CHOICE warranty liability extends only to the replacement cost of the product. In case GROWER'S CHOICE decides to replace the entire product, the limited warranty shall apply to the replacement product for the remaining initial warranty period.

GROWER'S CHOICE shall not be held responsible for any damage caused by the operation of the unit, be it incidental or consequential or any type including, without limitation, damage or injury caused to other products or machinery or buildings. Nor will responsibility be accepted for loss of time or profit, loss of finished product, or for any inconvenience caused in any way whatsoever.



Master Pursuit

By grower's choice

Tel: (909) 972-8419

E-mail: info@growersc.com

Website: www.growersc.com

Address: 1500 S Milliken Ave, Suite B, Ontario, CA, 91761

