

G



User Instructions

Villa Pergola motorized operation

Size: 13'x19' Double Bay

(400 x 600cm)

Size: 13' x 19'

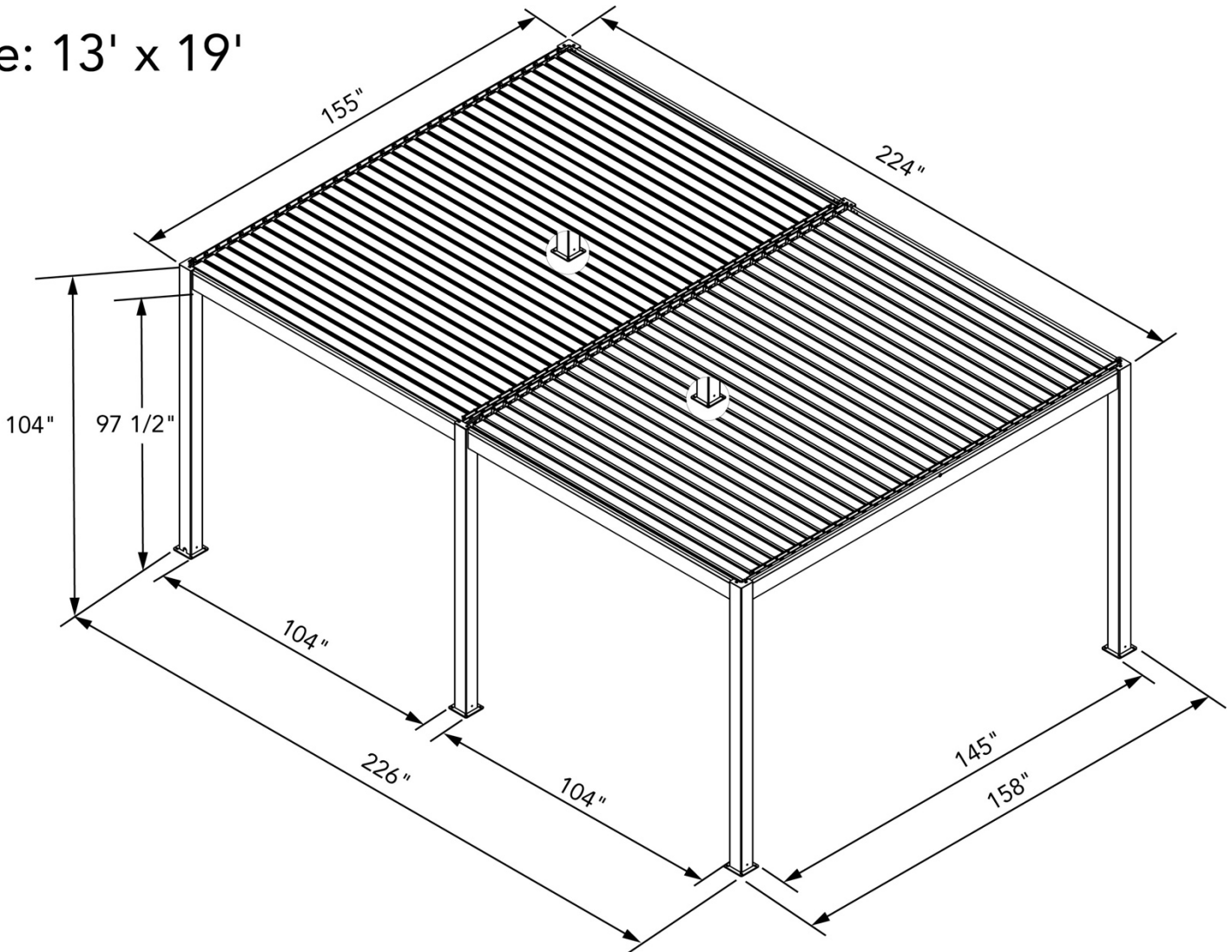

Tools and man force1-2

Parts List.....2-5

Product Description.....6

Safety Instruction.....6-7

Mounting.....8-17

Dismounting.....18

Storage.....19

Disposal.....19



Attention:

**Read this instruction manual carefully and completely before mounting and usage.
Keep this manual for future reference.**

Dear Customer,

Congratulations and welcome to our Villa Pergola family. To enjoy your Villa Pergola for its lifetime and for you and other's safety, please follow the assembly instructions.

Before you start the assembly process and using the Pergola, we suggest you are best to get familiar with this product. Make sure all parts listed up in below packing lists are delivered and intact. If you find that there are parts missing or damaged please do not install the pergola but contact us immediately. Do not start the assembly process if parts are missing or defective.

Tools and man force

Recommended: 2 or 3 people

Additional tools :



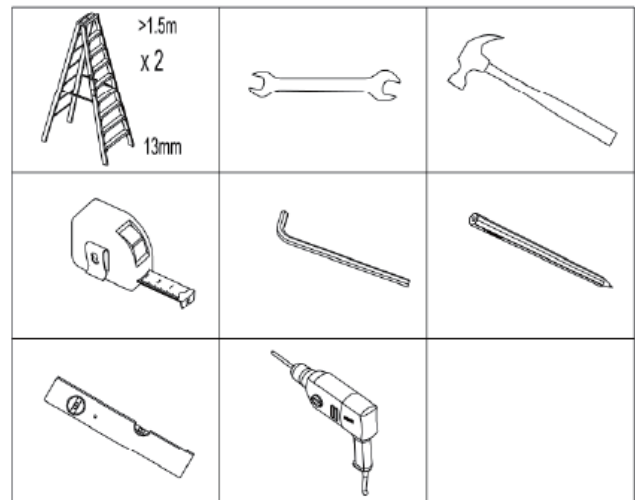
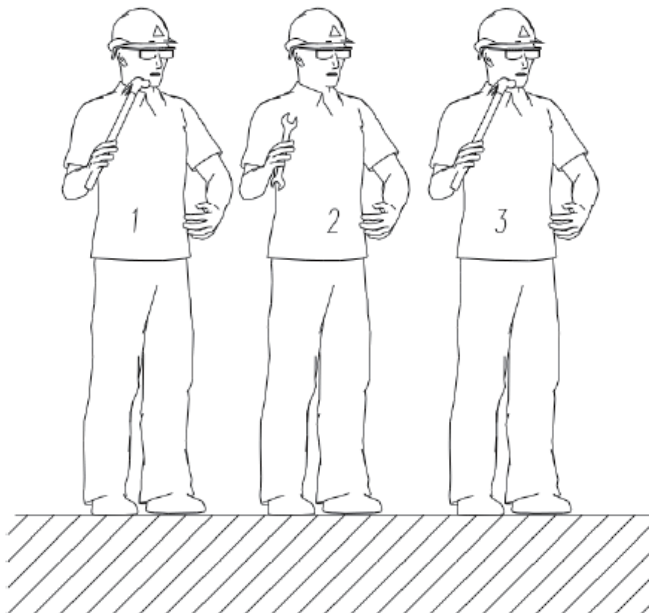











- | | | |
|----------------|--------------------------------|-----------------|
| 1.Ladder | 2. M10/13 open wrench supplied | 3.Rubber mallet |
| 4.Tape measure | 5. 5mm hexagon wrench supplied | 6.Pencil |
| 7.Spirit level | 8.Electric drill | |















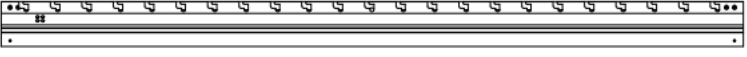



















Parts List

Please check all parts against the parts list before commencing construction of pergola.

SIZE: 13'x19' or 400X600CM (double bay) PARTS LIST

①	 x 12 M8X20	⑦	 x128 DAP25	⑬	 x 2
②	 x 4	⑧	 x128 M8	⑭	 x 2
③	 x 6	⑨	 x 1		
④	 x 4	⑩	 x 1		
⑤	 x 2 M10	⑪	 x24 M8X10C		
⑥	 x140 M8X20	⑫	 x4		

A-1			x 2
A-4			x 2
A-2			x 1
A-3			x 1
A-5			x 1
B-1			x 4
B-2			x 2
B-3			x 2
C-1			x 1

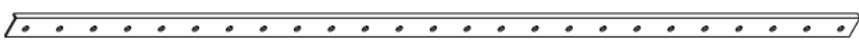
C-2			x 1
C-3			x 1
C-4			x 1
C-5			x 2
D-1			x 60
D-2			x 2
D-3			x 2
E			x 4

Hardware and other parts:

① M8x20 countersunk screw	② Screw for motor fixing	③ Base/Footing plate
④ Upright cover	⑤ M10 screw cap	⑥ M8x20 Hexagon bolt
⑦ Plastic Spacer	⑧ Locking nut	⑨ Motor 1 with motor bracket
⑩ Motor 2 with motor bracket	⑪ M8X100 expansion bolt	⑫ Gutter connector
⑬ 50 to 40 connector	⑭ 2 Remotes	

Aluminum profile parts list:

(A-1) Beam / (A-4) Beam	(A-2) Beam with motor direction left & slots
(A-3) Beam with motor direction right & slot	(A-5) Middle beam
(B-1) Gutter	(B-2) Gutter
(B-3) Middle Gutter	(C-1) Post + post connector
(C-2) Post + post connector	(C-3) Post + post connector

(C-4) Post + post connector	(C-5) Middle Post + post connector
(D-1) Common louver	(D-2) Center louver
(D-3) Driving louver	(E) Control rod (Driving Rail)

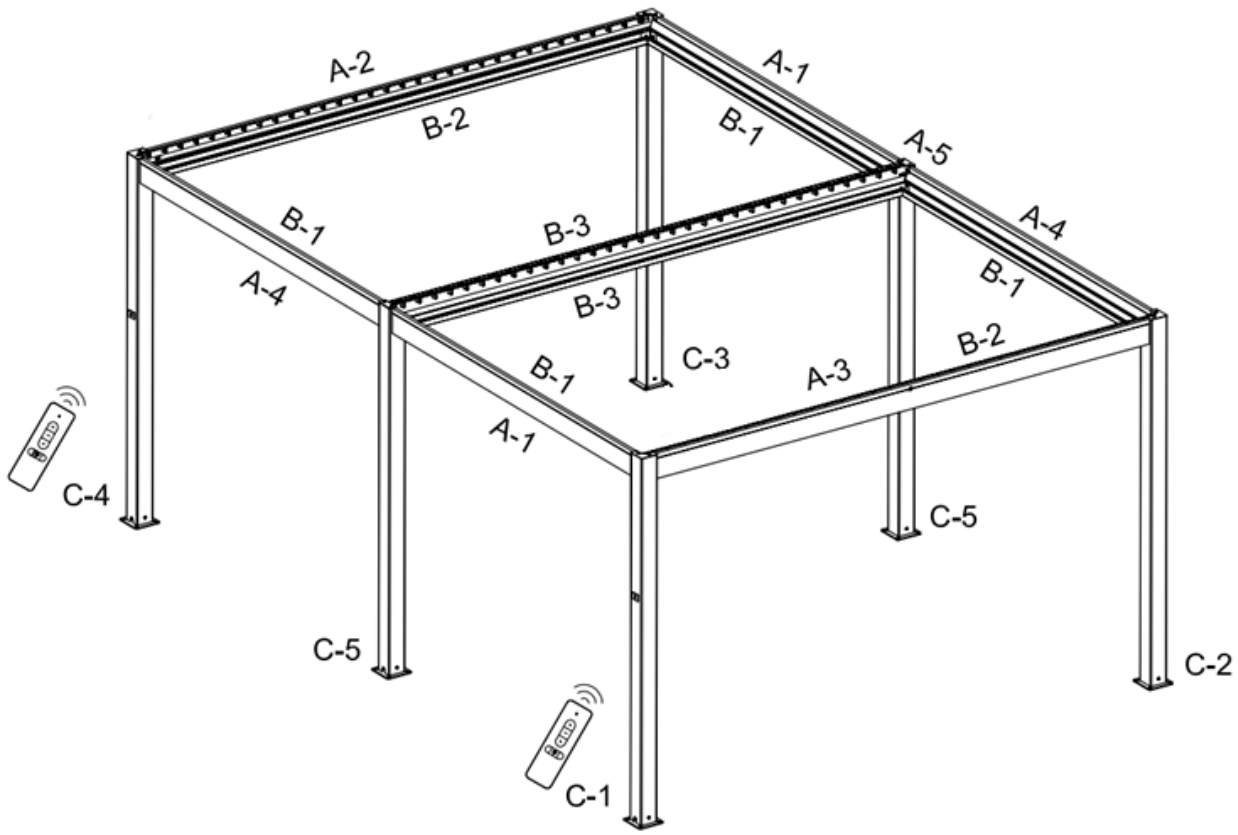

Product Description

Make the most of your outdoor living area with your pergola. Relax and enjoy the outdoors while being protected from sun. The coated aluminum frame pergola is perfect for shading your garden, deck, courtyard and swimming pool.

Important Safety Instructions

Warning: For the safety of you and other persons it is important to follow below instructions and obey warnings.

Symbol explanation



This warning triangle calls attention to hazards that that can lead to death or to severe injuries or which are important for the functioning of the Pergola.



This sign identifies important notes.

Safety instructions



To install this pergola technical knowledge is necessary. Do not mount this pergola yourself but contact a professional workman for help if

- ◆ you are unsure if the pergola can be mounted on the place you chose for installation.
- ◆ you do not understand the instruction manual or parts of it.
- ◆ you do not have necessary tools available.
- ◆ you do not have necessary technical knowledge



A minimum of three healthy adults are required to move and install the pergola as the product is big and heavy. Do not try to install the pergola alone. If the pergola falls, it could cause serious injuries and damages! Contact an authorized assembler for help.



Do not install the pergola when you find damage parts are that parts are missing. Contact your dealer.



Keep children and pets out of the working area during assembly and adjustments.



This product and its fixing parts are only suitable for installation on a plain cement wall or stable brickwork. If the wall/brickwork shows cracks you have to consult a professional.



Nobody is allowed to change the products' design and structure without the permission of manufacture or authorized deputy.



Please make sure that your hands are clean at the time of the assembly; otherwise you may soil frame.



Nobody is allowed to climb onto the Pergola. Hanging anything on the Pergola is forbidden.

Sheeting was used to protect the paint. This must be removed afterwards.

This structure is a non-permanent structure and the warranty does not cover damage incurred under extreme weather conditions including heavy rain, high winds or if exposed to high heat from heaters or BBQs.

Safety precautions should always be followed when assembling and using this product to reduce the risk of personal injury and damage to equipment. Please read all instructions before assembly and use. Never leave children unattended around/under this pergola. Do not attempt to assemble or use the pergola in moderate or heavy wind conditions. Always **keep the pergola louver open** and secure it during heavy winds or extreme weather conditions to avoid damage to the pergola or personal injury.







Mounting and usage

Step 1

Attach base plate ③x6 to the bottom of posts (C-1 x1,C-2 x1,C-3 x1,C-4 x1,C-5 x2),use bolts ① x12 to attach with hex key or electric drill.

C-1&C-3 ,C-2&C-4, C-5&C-5 posts should be installed diagonally as below.





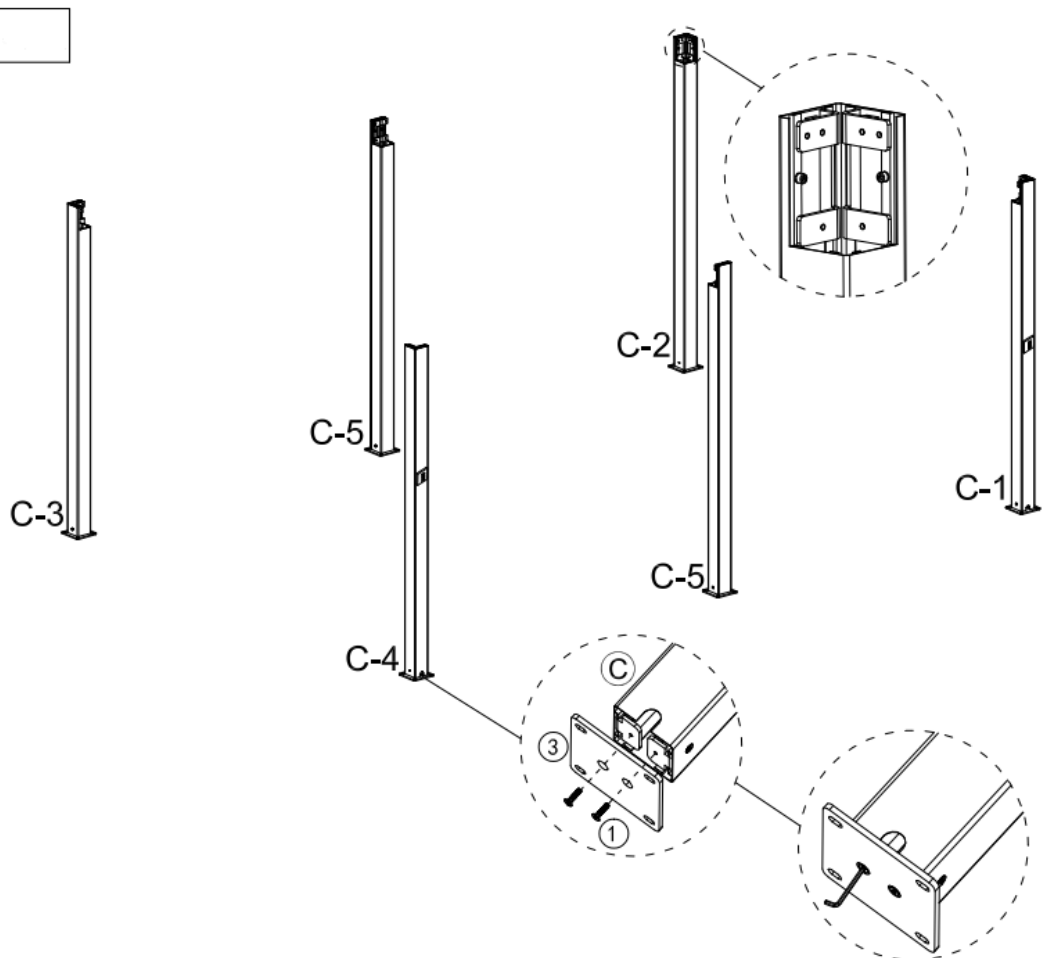

Please make sure all posts on the same horizontal plane.

① x 12		
③ x 6		
C-1 x 1		
C-2 x 1		
C-3 x 1		
C-4 x 1		
C-5 x 2		



Step 2

Attach beam A-1 x2 ,beam A-4 x2 ,beam A-2 x1,beam A-3 x1 ,beam A-5 x1,use bolts ⑥x32 to fasten.

⑥x32		
A-1 x2		
A-4 x2		
A-2 x1		
A-3 x1		
A-5 x1		

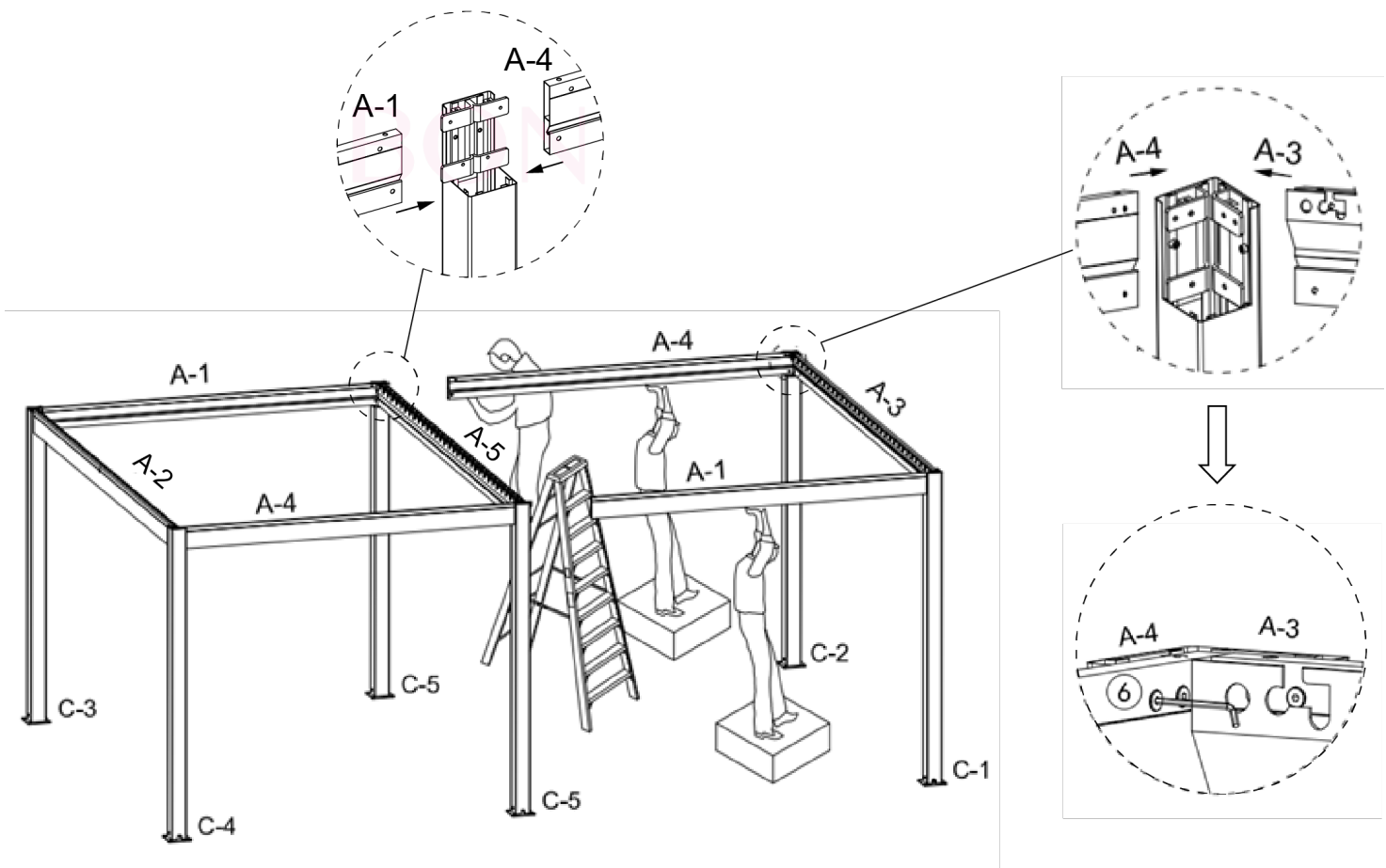

Step 3

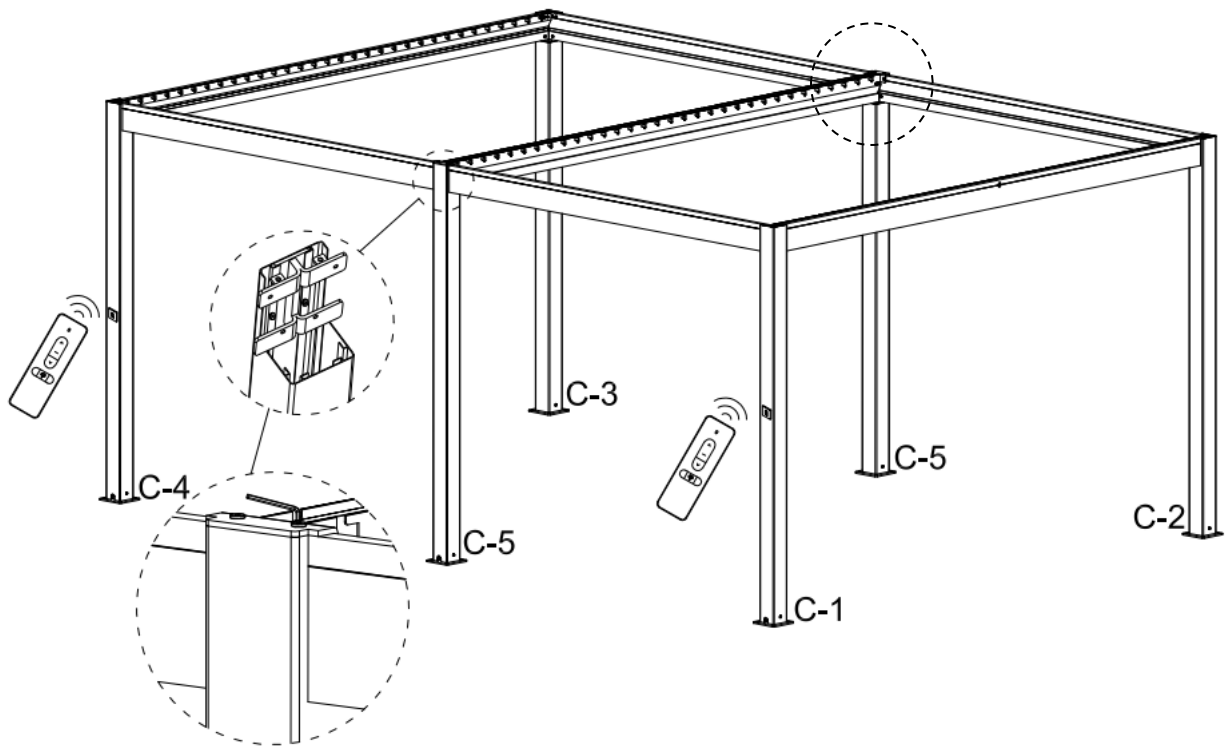
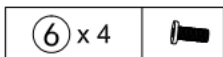

Use bolts ⑥x4 to fasten both sets of beam A-1 & beam A-4.

*****Note: This process is extremely important to ensure the structure is stable.**



Step 4

Attach upright cover ④x4, use bolts ⑥x8 to fasten

⑥ x 8		
④ x 4		

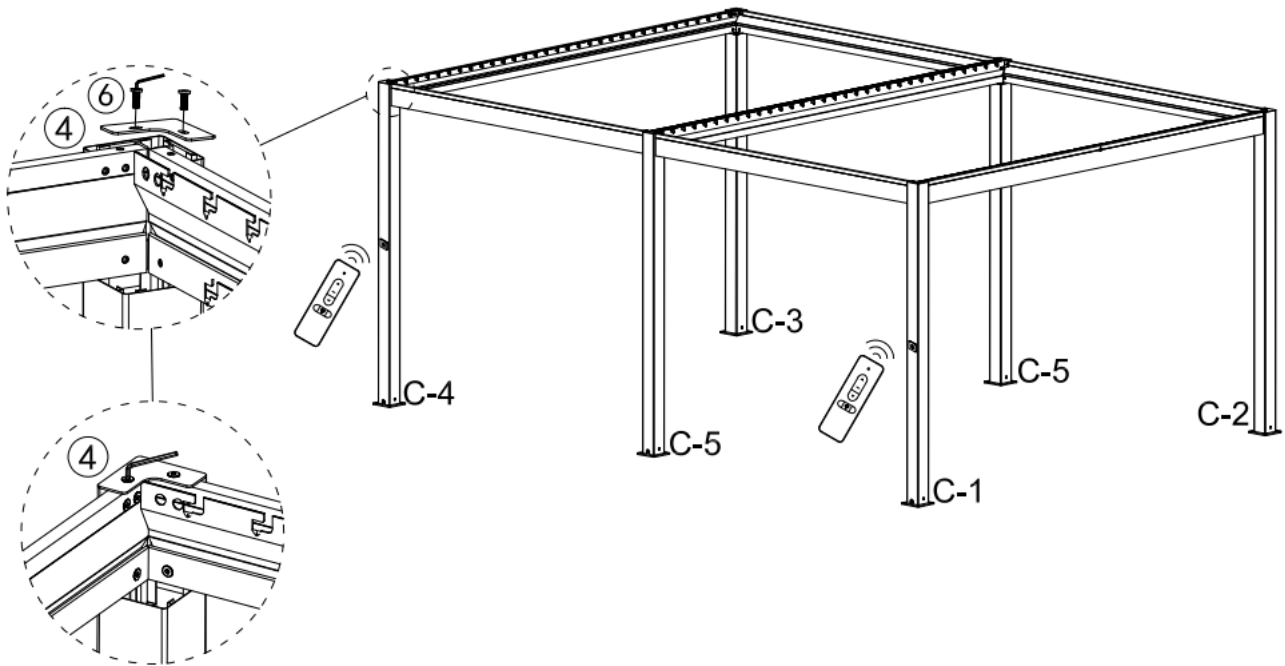

Step 5

1. Slide the ⑨ and ⑩ motor into B2 gutter before hooking onto the A2 & A3 beam in the direction as shown below.
2. Attach all eight gutters B-1 x4, B-2 x2, B-3 x2 by hooking inside the A-1, A-2, A-3 beams.

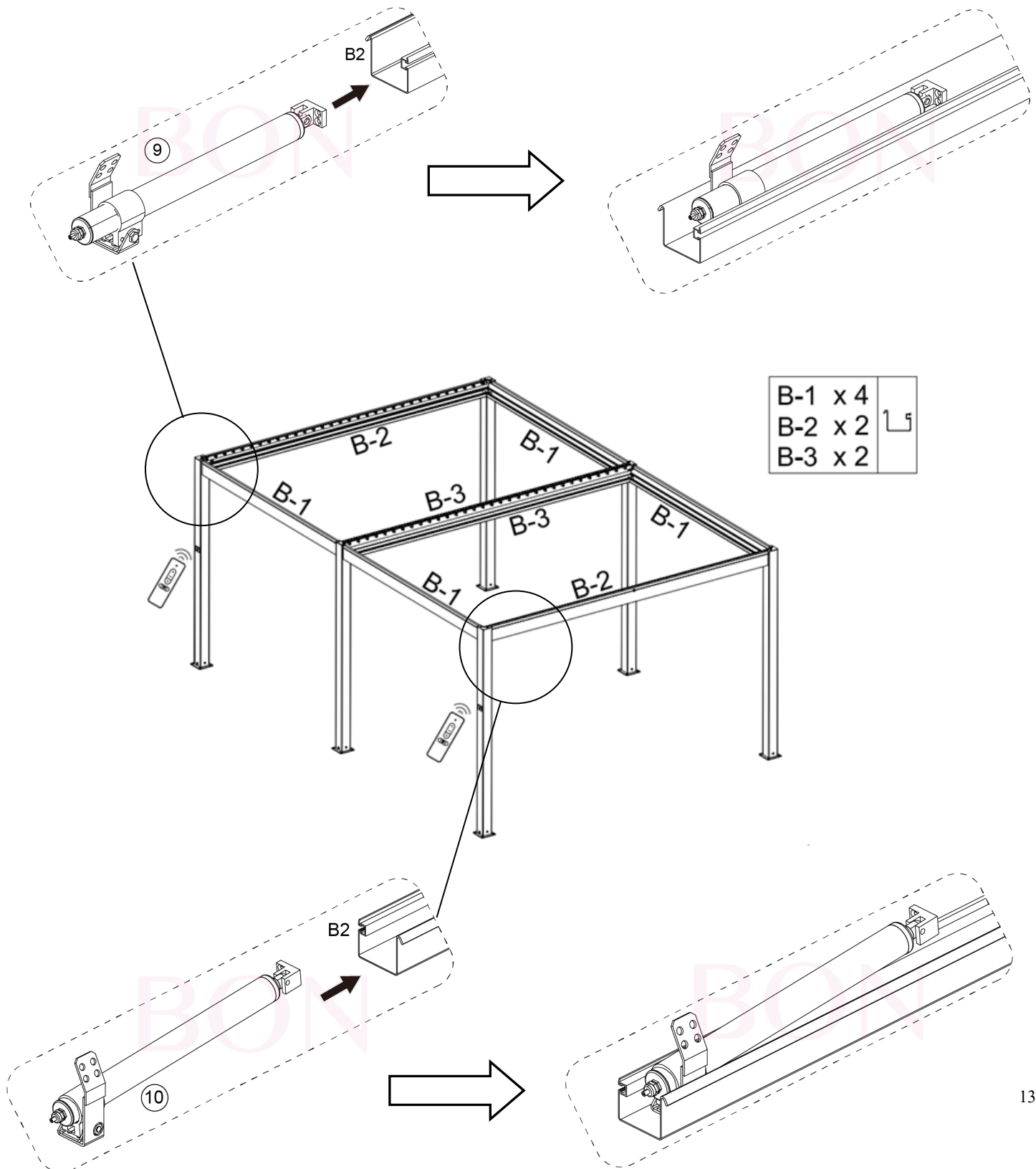

Step 6

Fasten motor ⑨x1 + ⑩ x1 with its screws as shown below.

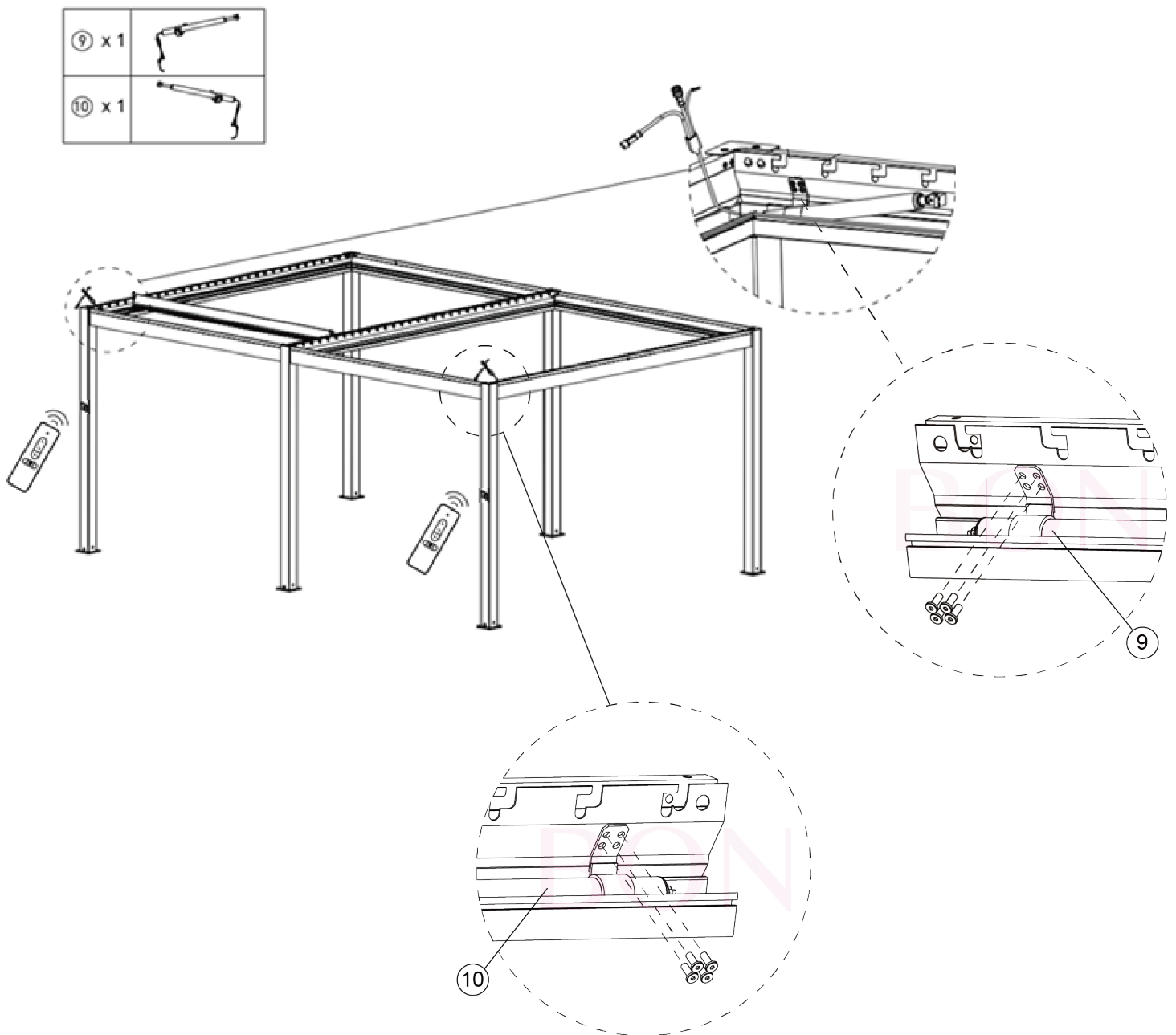

Step 7

1. Fasten ⑫x4 gutter connector (x6 for certain model)
2. If motor wire is running downward through the post, use ⑬ to connect with ⑫ as shown below to not allow water drain through this post.

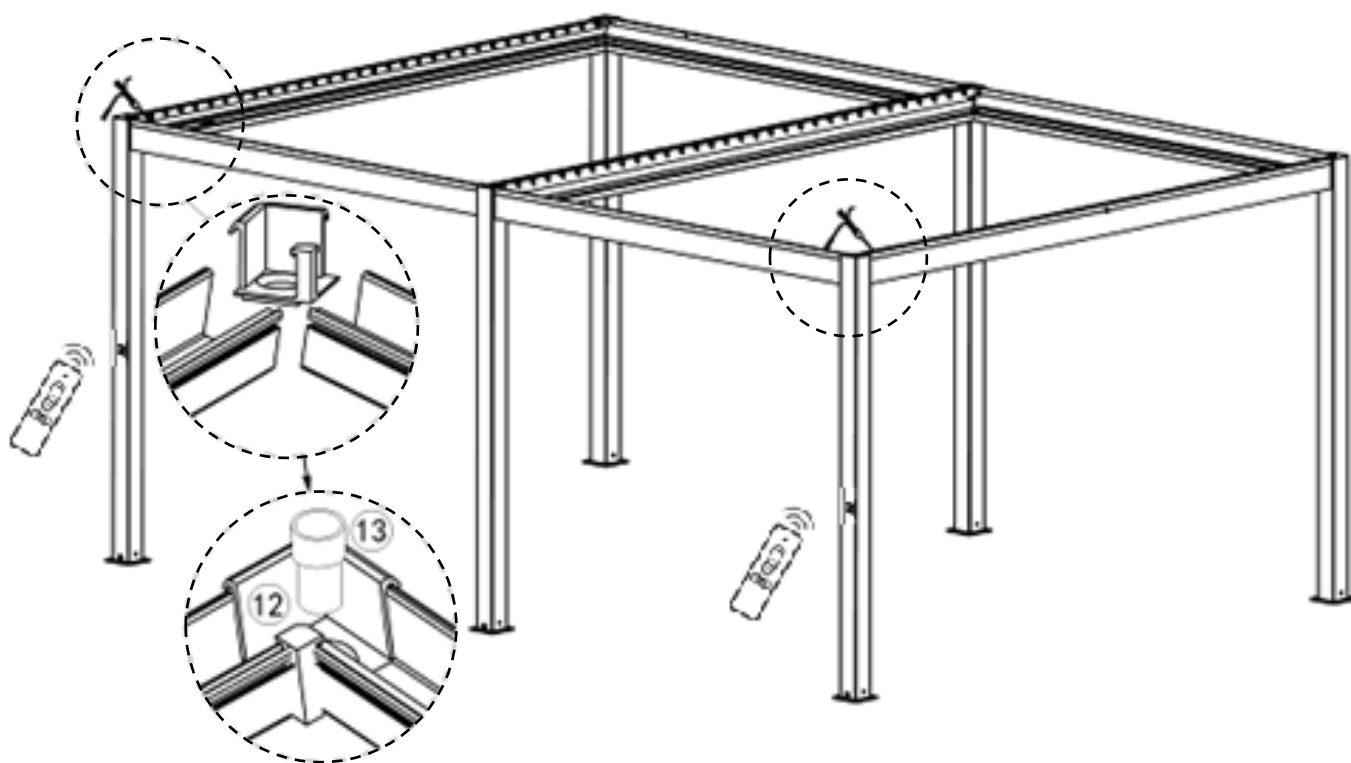
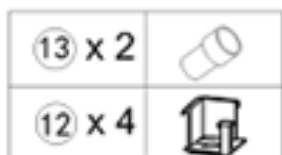

Step 8

Connect the female and male plugs for the LED lighting (DC24V to DC24V) and motor (DC24V to DC24V) and plug the power cable into local socket.

***Note: You can test your motor at this stage. Plug in and use its remote.

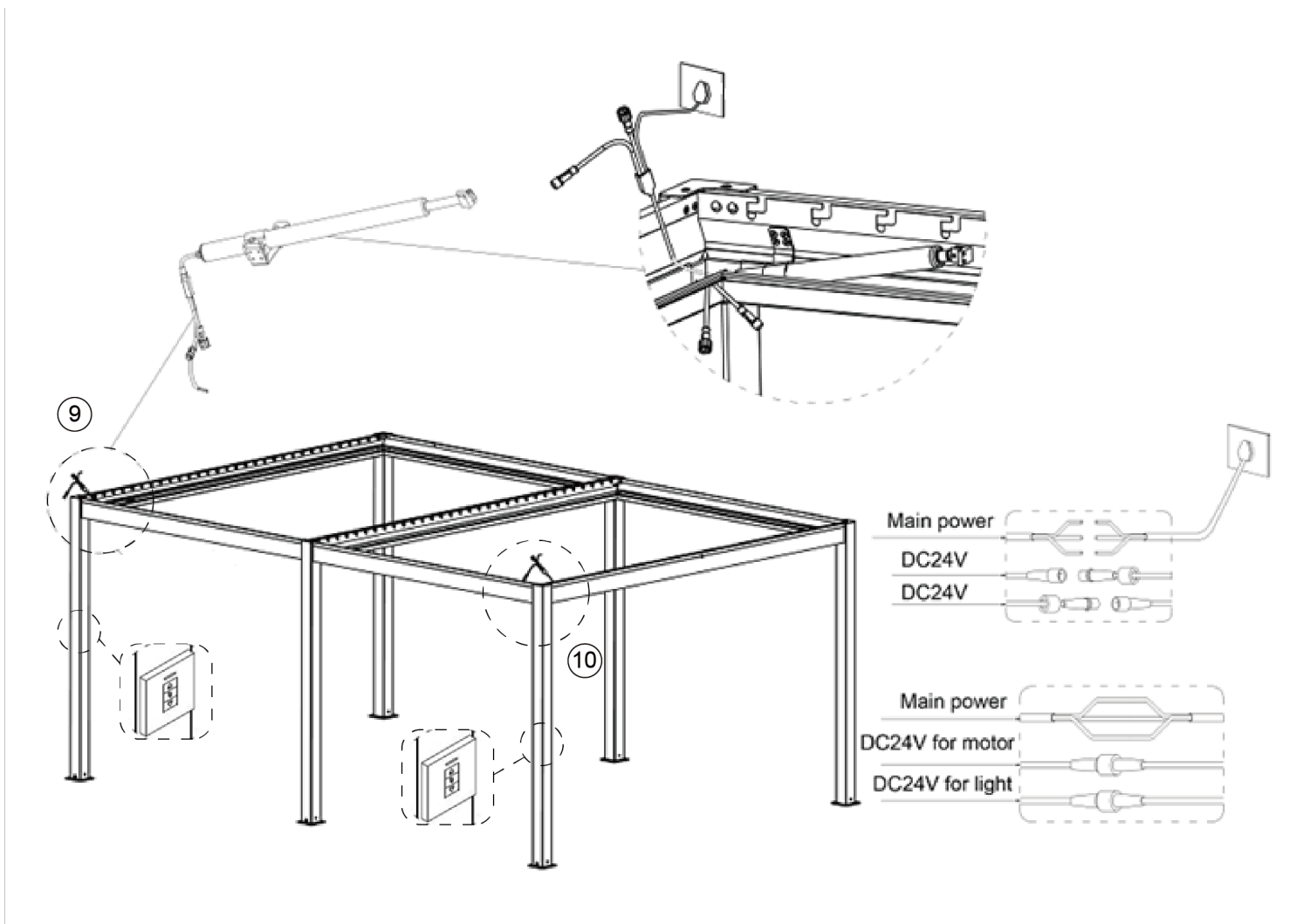

Step 9

1. Located holes in center of beams(A-2,A-3,A-5)
2. Place **Center Louver D-2** into center hole/slot which on beam **A-2,A-3,A-5**, lining up with the holes for 13' x19' (600*400 cm) size.
3. Use M10 nut (5) x2 to secure the **Center Louver** in place
4. Place **Driving Louver D-3** in line with 7th slot(check below direction) on the beam **A-2,A-3,A-5**,
5. Place all **Common Louvers D1** into the remaining slots in the beams

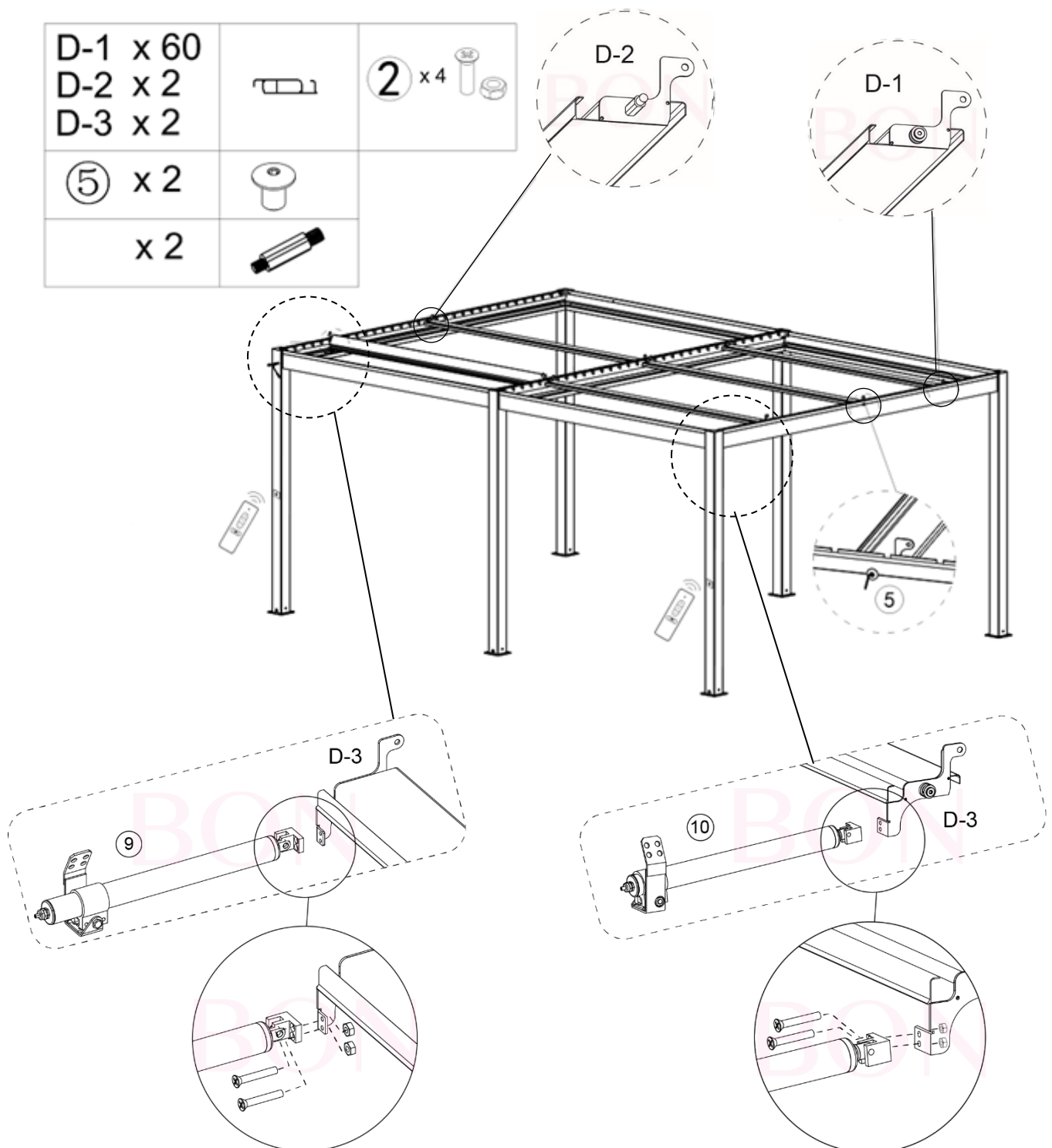

Step 10

Fix ④ x 4 (flat L-shaped aluminum profile).





One for each side on the louvers is required.

Use bolt ⑥ x 128, plastic spacer ⑦ x 128 and nut ⑧ x 128 to tighten for 600X400cm size.

Secure the louvers at each end.

Tip: Do one sections of louvers first, then when installing the other side, screw, and bolt per louver one by one (especially the side that is at the center).

NOTE: Do not over tighten the nuts and bolts. Over tightening will prevent louvers from moving.

⑥ x 96	⑦ x 96	⑧ x 96	④ x 4
			

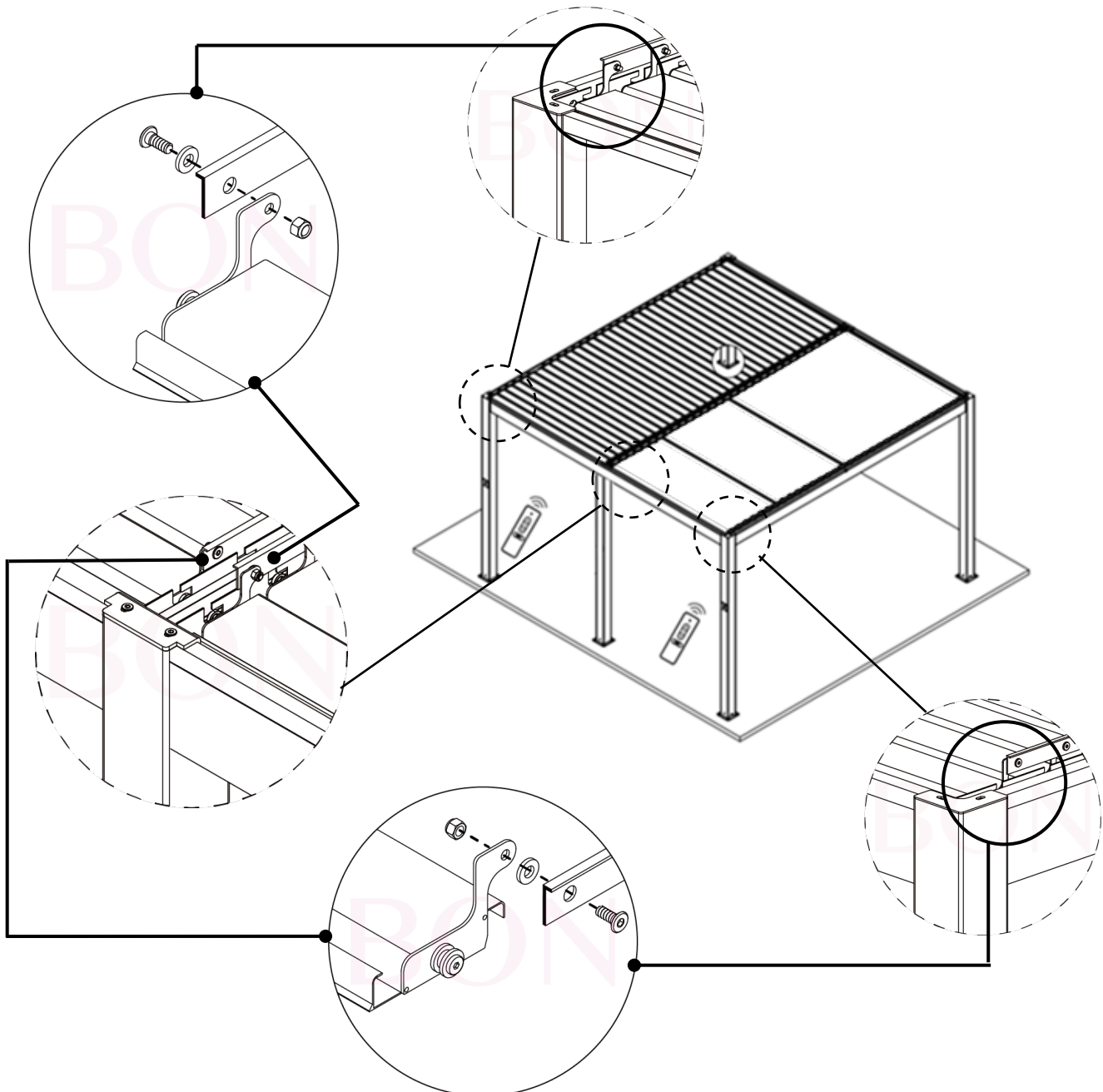

Step 11

Mark holes for expansion bolt ⑪x4 on each post.

Note the drill size should be 12 mm.

Insert the bolts. Use a hammer drill if necessary.

Place the posts over the bolts. Tighten the nuts.

Once installed, make sure any remaining plastic is removed and silicone is used along all corners and gutters to be waterproof.

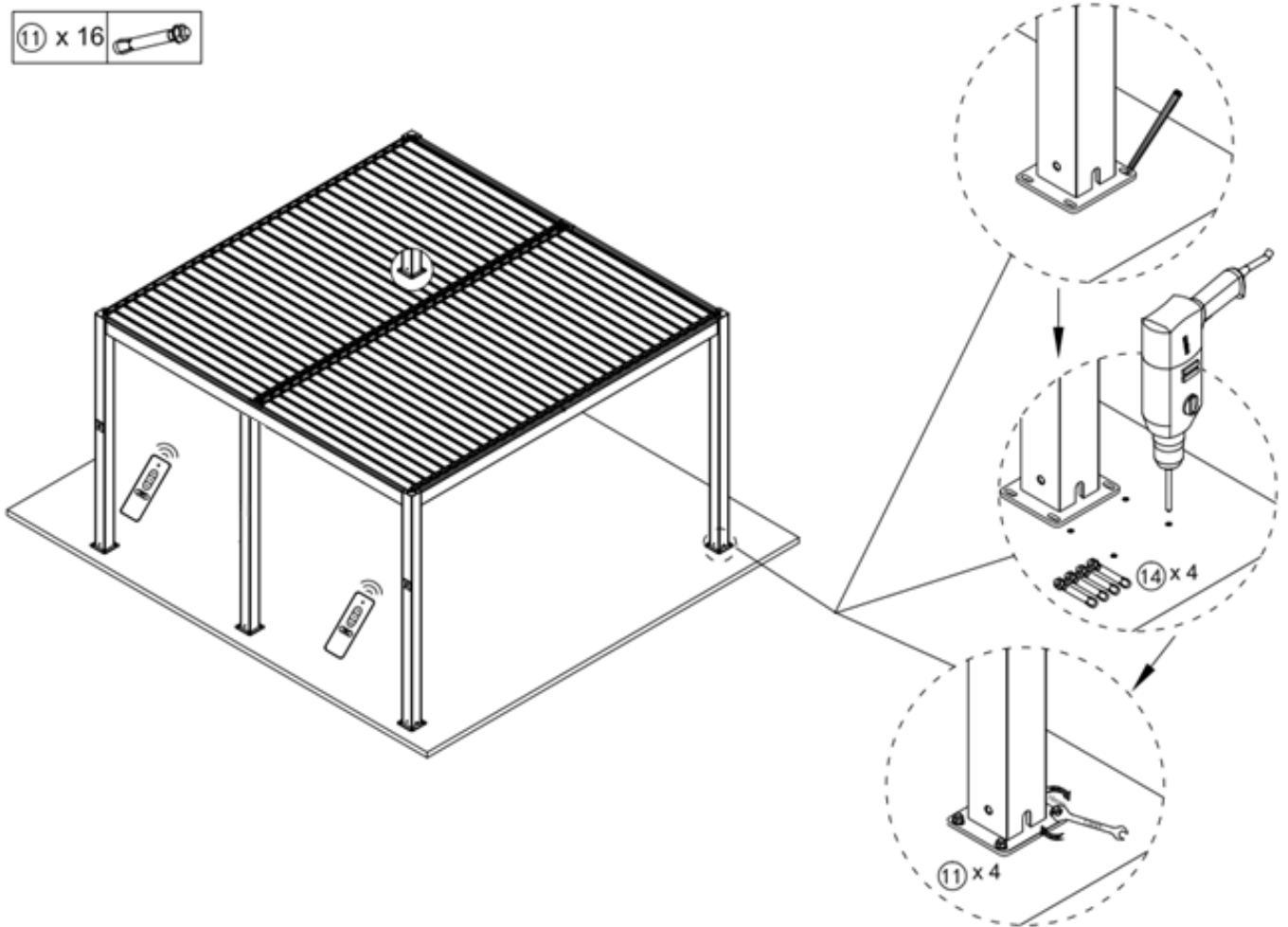

WARNING: Make sure louvers are open when mild to strong winds occur for safety.

Operating Instructions for Remote Controller with Light Control

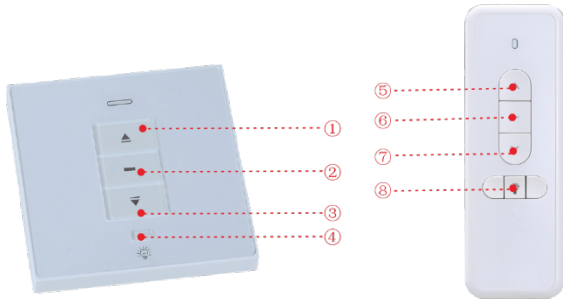

- HC-PM03F\D-T1
- ①Motor: Up button
 - ②Motor: Stop button
 - ③Motor: Down button
 - ④Light bulb: turn on/off button

- HC-PM03\D-T1
- ⑤Motor: Up button
 - ⑥Motor: Stop button
 - ⑦Motor: Down button
 - ⑧Light bulb: turn on/off button

1. Function and Features

- ※ 86mm*86mm, in accordance with international installation standard;
- ※ The electric structure is partial conformity with the standard fire protection requirement of the electrician;
- ※ Industrial grade microcomputer chip is used to improve product quality and reliability greatly;
- ※ Use shock-proof current relay;
- ※ Components using precision SMT industry, surface moisture-proof treatment;
- ※ Power supply has safety protection, power supply time is 5 minutes;
- ※ It is used with various emitters and tubular motors.

2. Product Parameters

Product name	Remote controller with light control
Product model	HC-PM03F\D-T1
Receiving/transmitting frequency	433.92MHz
Working temperature	-20°C~ +85°C
Receiving sensitivity	-110dBm
Allowed number of transmitters	≤8pcs

Product name	Remote controller with light control
Product model	HC-PM03\D-T1
Receiving/transmitting frequency	433.92MHz
Working temperature	-20°C~ +85°C
Receiving sensitivity	-110dBm
Allowed number of transmitters	≤8pcs

3. Operating Instruction

A. Learning code

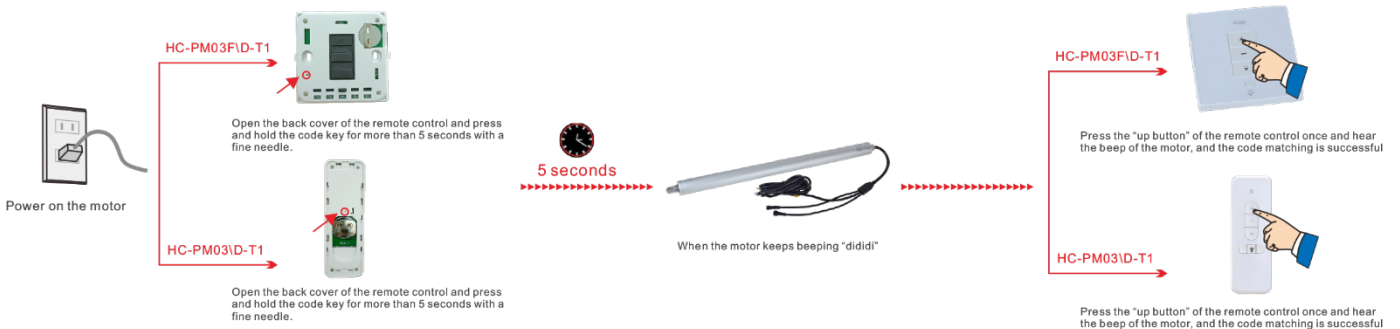

B. Deleting code

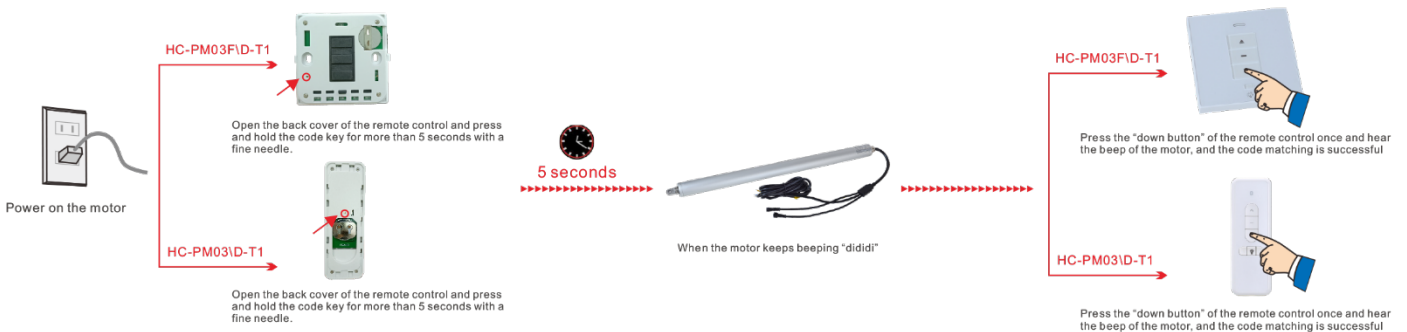

Dismounting

If you want to disassemble the Pergola, please follow the following process.

Attention! At least two people are needed for this step.

- ◆ Keep the Pergola louvers open before you begin with dismounting. Bind the Louvers of the Pergola together to avoid unintended unfolding. This might cause damage and injury. You can use the protection band that was fixed on the Pergola when purchasing it.
- ◆ Follow the mounting instructions in reversed order to dismount the Pergola.
- ◆ Make sure that drilling holes in the wall will be sealed professional.
- ◆ **Attention! Safety hints and instructions have to be followed for dismounting as well.**

Storage

When you do not want to use the Pergola for a longer period of time it is recommended to take the Pergola out of the brackets and store it.

- ◆ Make sure that the frame is dry completely before storing.
- ◆ Store the Pergola at a dry and safe place that is not reachable for children.

Disposal

Do not dispose this Pergola with other household wastes. To prevent possible harm to the environment or human health from uncontrolled waste disposal, recycle it responsibly to promote the sustainable reuse of material resources. To return your used device, please use the return and collection systems or contact the retailer where the product was purchased. They can take this product for environmentally safe recycling. Dispose packing materials according to local guidelines.