

# **Users' Manual**

**Wellness Steam Shower Cabins (S6)**

Please read the user's manual carefully before using the product.

# INDEX

- ▶ Safety Notes
- ▶ Parameter for Steam Cabin
- ▶ Parts Information
- ▶ User's Manual
- ▶ Steam Generator Cleaning
- ▶ Trouble Shooting

## SAFETY NOTES

1. The power supply must be installed according to the local standard and with GFCI (Ground Fault Current Interrupter). Test the GFCI before using to confirm its security and validity.
2. The earthing for electrical appliances should be connected to fixed earth wire forever.
3. To avoid electric shock, replacing of power supply wire should be done by professional electrician or distributor. User should not change it by himself.
4. To avoid electric shock, no extending power supply should be used. The socket should be in right position. Broken electric wire should be changed in time.
5. It's forbidden to make any change, adding or cutting to the product.
6. It's forbidden to use the product after drinking or taking hypnotic medicine.
7. Children should use the product under custody from adults.
8. Adjust the low water temperature to high water temperature slowly to avoid scald.
9. Stop using the product in case user feels uncomfortable.

## Parameter for Steam Cabin

Rated Power:  3.0KW  4.5KW

Rated Voltage:  Single Phase AC220V  Double Phase AC240V  
 Single Phase AC110V

Rated Electric Current:  16A  20A

Frequency:  60Hz  50Hz

Power Supply Location:  on wall  on floor

Rated Water Pressure: 0.2--0.6 MPa

Water Supply: DN15 tie-in, hot/cold water

Water Supply Location:  on wall  on floor

Diameter of Drainage Pipe:  $\phi$  50 (drainage pipe supplied with product)

Length of Drainage Pipe: 1000mm (the maximum length after stretched)

## Parts Information

### ● LCD DISPLAY

1. Fahrenheit degree
2. Celsius degree
3. Temperature
4. Temperature indicator
5. Time setting
6. FM radio frequency
7. FM radio volume
8. FM radio channel
9. Chromatherapy on/off
10. Ventilator on/off
11. Steam on/off
12. Power on indicator
13. FM radio frequency
14. Mp3 on/off

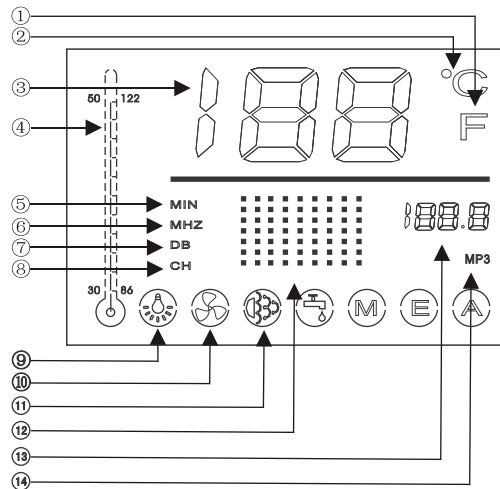

## Parts Information

### ● Control Panel for Steam Cabin

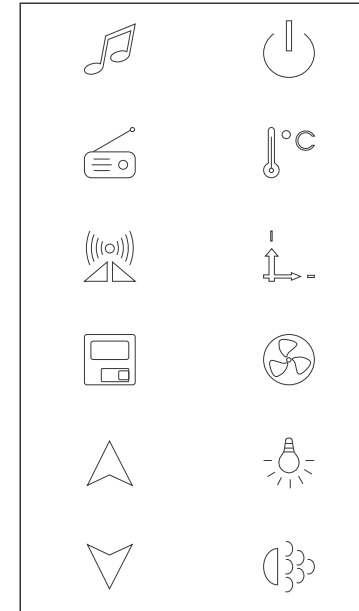

- Power on/off
- Steam temperature setting
- System time setting
- Ventilator
- Chromatherapy
- Steam on/off
- MP3
- Radio
- Volume/Frequency
- Radio memory
- + adjustment
- adjustment

### ● Control Parts Information for Steam Cabin

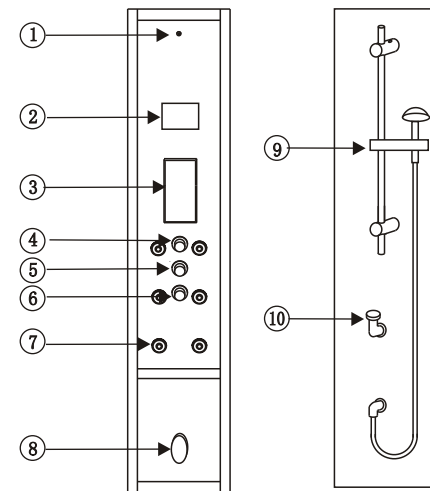

- ① Steam Temperature Sensor
- ② LCD Display
- ③ Control Panel
- ④ Water Diverter
- ⑤ Water Volume Adjustment
- ⑥ Water Temperature Adjustment
- ⑦ Back Massage Jet
- ⑧ Steam Outlet
- ⑨ Hand Shower Set
- ⑩ Steam Generator Cleaning Liquid Inlet

## Power on/off

Push any button to light the display and picture 1 shows on screen. Push power on/off button now to start the system and picture 2 shows on the display. Push power on/off button again to shut off the system. The display and background light for push buttons are turned off. The drain valve for steam generator keeps on for 1 minute.

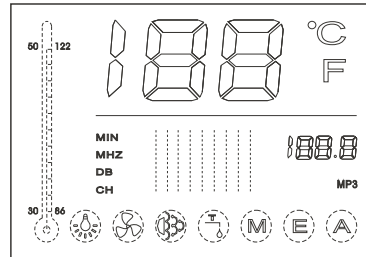

Picture 1

## Steam temperature setting

Keep on pushing this button and picture 3 shows on display. The figure of temperature is changing from 20 to 59 circularly. Loosen the button when the figure reaches the desired temperature and the figure is set as steam setting temperature. The steam generator stops working when the temperature inside steam cabin is higher than setting temperature. The steam generator starts working automatically when the temperature is lower than setting temperature. The default steam setting temperature is 45°C/113F if the user does not make any steam temperature setting.

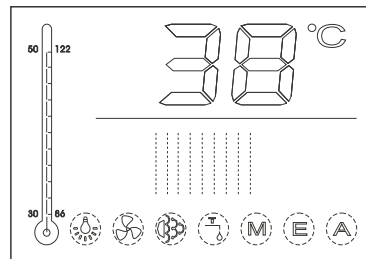

Picture 2

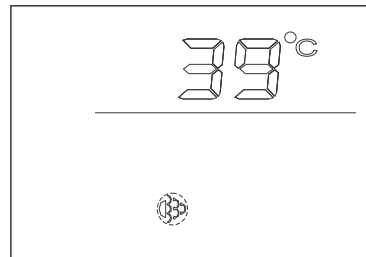

Picture 3

## System time setting

Keep on pushing this button and picture 4 shows on display. The figure is changing from 20-59 circularly. Loosen the button when the figure reaches the desired one and the figure is set as working time for system.

The system is automatically shut off when the working time reaches the setting time. The default working time is 45 minutes if the user does not make setting for working time of the system.

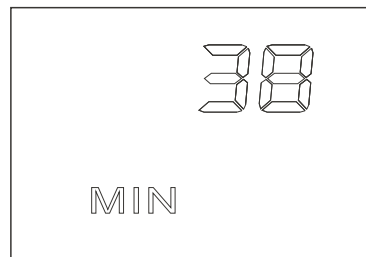

Picture 4

## Chromotherapy

This button controls the color of chromotherapy lamps (picture 5). When chromotherapy function starts, the lamp symbol on LCD display twinkles (picture 5).

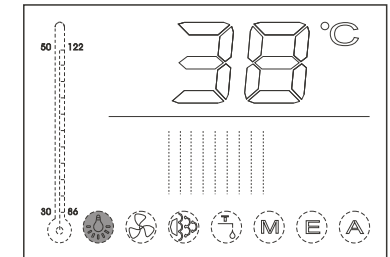

Picture 5

## Ventilator

- This button turns ventilation on/off. When ventilation is on, the ventilation symbol on LCD display twinkles.
- Celsius/Fahrenheit Conversion  
Keep on pushing this button for at least 3 seconds to make conversion between Celsius degree and Fahrenheit degree. And the picture is changing between PICTURE 7 and picture 8.

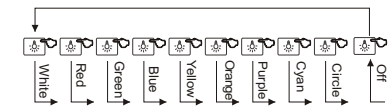

Picture 6

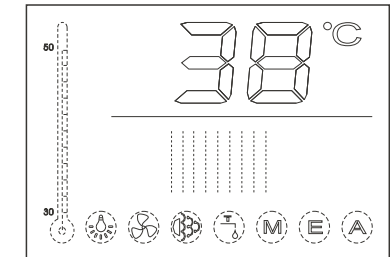

Celsius degree Picture 7

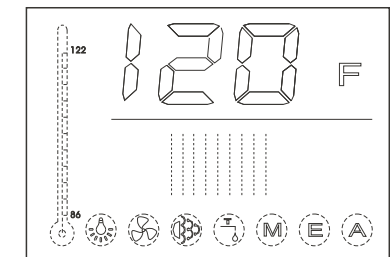

Fahrenheit degree Picture 8

## Steam on/off

This button turns steam on/off. Push this button, the steam symbol is twinkling on LCD display. The steam function is automatically turned off when the temperature inside steam cabin is higher than the set temperature. And the steam function will be turned on automatically when the temperature inside steam cabin is lower than the set temperature.

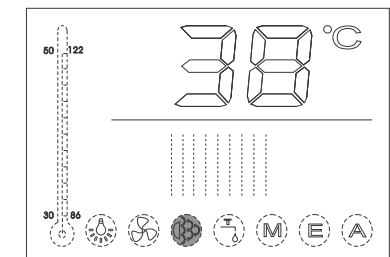

Picture 9



## MP3



MP3 Setting:



- First choose a radio frequency as MP3 channel. Please note that the radio frequency chosen should have no radio station. Set the same frequency as the emitting frequency of the MP3 emitter.
- Start MP3 function.
- Adjust frequency of FM radio to get the same frequency as that of MP3 emitter.
- Adjust volume of FM radio. It will be set as the default volume of MP3.
- Push Mp3 button for over 3 seconds to finish setting.

## FM radio on/off

Push this button and picture 11 shows on the display. And FM radio is on. The radio frequency by default is the same as the radio frequency selected last time.

## Volume/Frequency adjustment

● Volume adjusting:  
Push this button when FM radio is on and picture 12 shows on the display. Push   button again to adjust volume.

● Frequency adjusting:  
Push this button twice when FM radio is on and picture 13 shows on the display. Push   button again to adjust frequency.

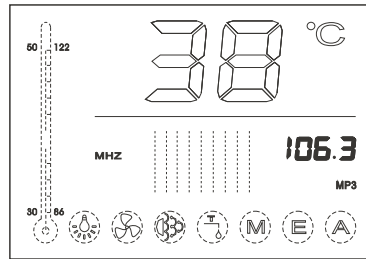

Picture 10

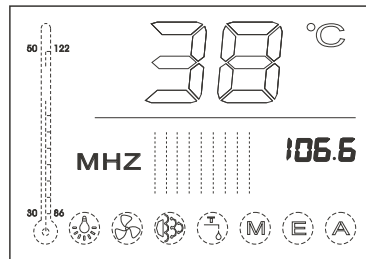

Picture 11

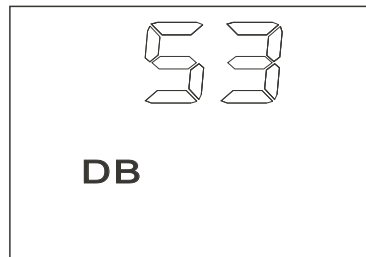

Picture 12







Picture 13





## Channel Memory

Channel Memory Setting:

- Start FM radio
- Set serial number: push  button shortly and picture 14 shows on display; push  button shortly again, figure from 1 to 8 shows circularly; stop pushing this button when the wanted figure shows.
- Adjust FM radio to your favorite channel; push  button to adjust frequency and volume.
- Channel Memory: Push  button for more than 3 seconds; the figure shows +1 and turns to original setting serial number. Stop pushing this button to finish setting for one channel. If the serial number is used for another channel, this channel will be replaced by the new channel in memory.
- Repeat the above steps to get the favorite channels in memory. At most 8 channels can be in memory.

Find channel:

- Start FM radio. Push  button shortly to find right channel in memory.

 + adjustment

 - adjustment

The above 2 buttons are used to adjust frequency and volume.

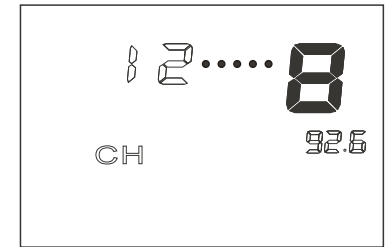

Picture 14

## Steam Generator Cleaning

Remove the cover of cleaning liquid inlet and input around 1L of citric acid or acetic acid. Then start steam function to fill steam generator with water. Stop steam function before steam coming out (acid steam has causticity to plated parts. If a lot of acid steam come out, the plated parts become cloudiness after some time.) Do not shut off the control system and keep it on. The scale in the steam generator dissolves in acid liquid and the system drains the dirty water out automatically after 60 minutes. Clean the steam generator every 3 months.

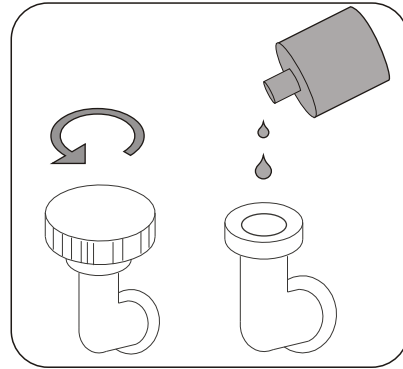

## Trouble Shooting for Steam Cabin

TROUBLE	CAUSE	SOLUTION
Touch panel does not work.	1.Communication line is short circuit or open circuit.	Check connection between control panel and power box.
	2.The control system is wrong.	Change control panel or power box.
No Steam	1.The water supply is shut off.	Turn on the water supply valve.
	2.No water supply in this area.	Use the product when water supply is normal.
	3.The water inlet valve cannot be turned on.	Check water inlet valve and output signal from it.
	4.The water level sensor is wrong.	Clean scale on water level sensor or replace it.

## Trouble Shooting for Steam Cabin

TROUBLE	CAUSE	SOLUTION
No Steam	5.Thermal switch in the heater is wrong.	Change thermal switch installed inside the heater.
	6.The heater is wrong.	Change the heater.
	7.The set temperature is lower than room temperature.	Reset temperature.
Steam generator keeps adding water.	1.The water inlet electromagnetic valve is wrong.	Replace water inlet valve
	2.Water level sensor could not detect signal.	Clean scale on water level sensor or replace it.
Power supply is off when on/off button is pushed.	1.There is creepage from heater.	Replace heater.
	2.There is creepage from thermal switch inside heater.	Replace thermal switch.
Water leaks from valve.	The seal is damaged.	Change the seal.
Water flow volume is low.	Water supply has impurities and jammed the filter net.	Get filter net cleaned.

# S6 Wiring Diagram

## Power Box

