



# GAZEBO Penguin Inc.

4660 HICKMORE ST,  
MONTREAL, QUEBEC  
H4T 1K2  
TEL: 1-514-276-3485, 1-800-737-7174  
Email: customerservice@gazebopenguin.com

**43226MR-22 BROWN**  
**43226MR-32 SLATE**

PLEASE READ  
IN ITS ENTIRETY  
BEFORE  
INSTALLATION

## METAL ROOF 12'x16' GAZEBO ASSEMBLY INSTRUCTIONS

PLEASE READ  
IN ITS ENTIRETY  
BEFORE  
INSTALLATION

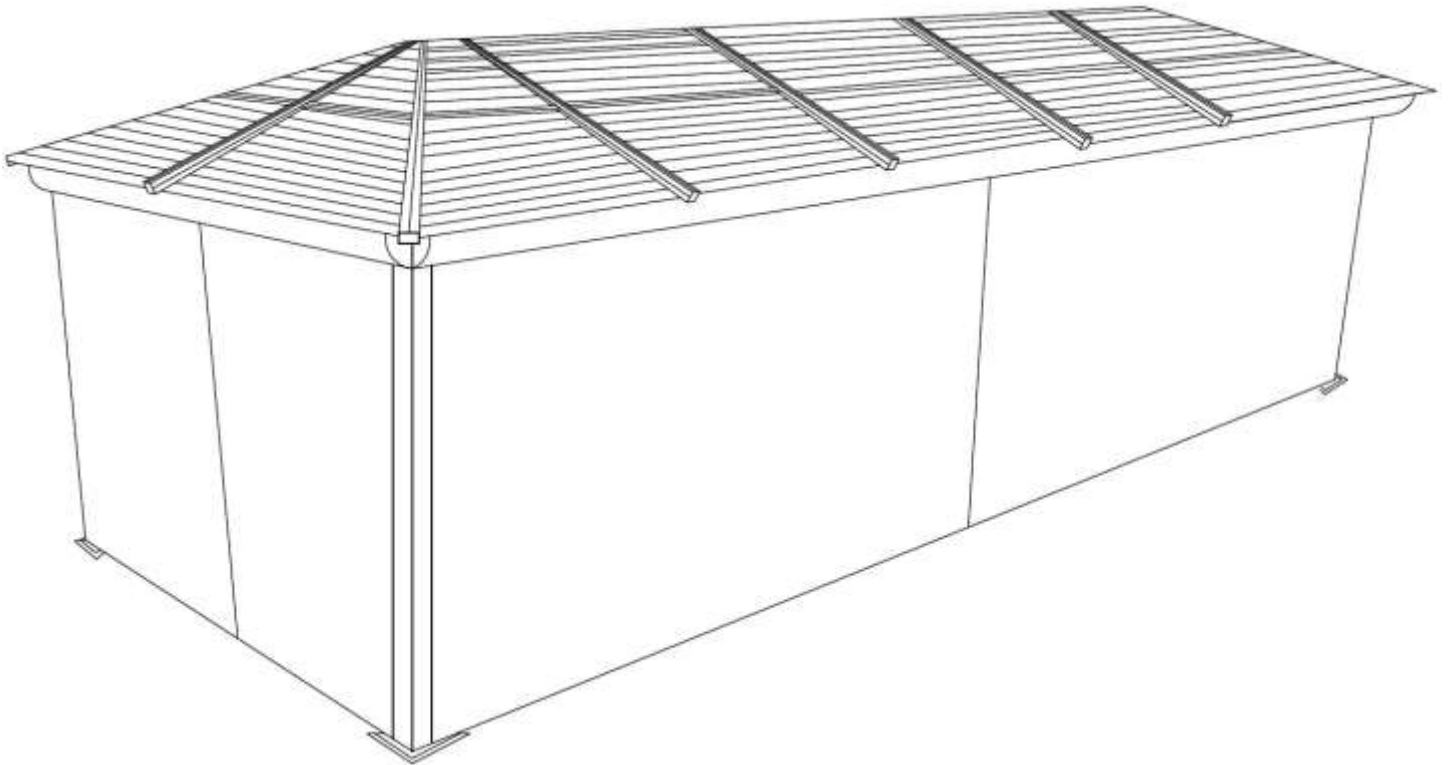

**DO NOT DESTROY THE BOXES UNTIL COMPLETELY ASSEMBLED  
FOR FUTURE REFERENCE,  
TAKE PICTURES OF ALL SIX SIDES OF EACH OF THE BOXES UPON RECEIPT.  
PLEASE VERIFY THE CONTENT OF EACH BOX AGAINST THE LIST OF PARTS**

Assembly With Two Or More Adults Recommended

Base Dimensions 10' 11" x 15'6"  
Largest Dimensions 11' 11" x 16'2"  
Overall Height 108.5"

{ APPROX. }

**DO NOT DESTROY THE BOXES UNTIL COMPLETELY ASSEMBLED  
FOR FUTURE REFERENCE,  
TAKE PICTURES OF ALL SIX SIDES OF EACH OF THE BOXES UPON RECEIPT.  
PLEASE VERIFY THE CONTENT OF EACH BOX AGAINST THE LIST OF PARTS**

**12ft x 16ft / 3.66m x 4.88m GAZEBO**

**Instruction Manual**

**IMPORTANT: RETAIN FOR FUTURE REFERENCE, READ CAREFULLY**

Consult with your local governing authority / local municipal codes regarding installation of temporary structures before purchase or assembly. Some jurisdictions may require permits for, or otherwise regulate, installation and use.

For assistance with assembly, installation, parts, or customer service, contact Gazebo Penguin Customer Service Department at the numbers listed below (English & French, Mon-Fri 8:00 AM to 4:00 PM EST):

**Montreal:** (514) 276-3485

**Elsewhere in Canada and the US:** 1-800-737-7174

**WARNING:**

- For outdoor use.
- Snow should be regularly cleared from the roof and not allowed to accumulate.
- Retain your **proof of purchase** for warranty purposes. Also keep the **original boxes** until the installation is complete and correct.
- The unit may take more than 4 hours and 3 people are required for this assembly.



**PRIOR TO ASSEMBLY:**

- Please don't destroy boxes until completely assembled.
- The foundation must be level, flat, and solid, such as concrete or asphalt.
- Keep away from overhead utility lines, tree branches, and other structures.
- Check for underground pipes or wires if digging or drilling is required.
- Do not install near roof lines or other structures that could shed snow, ice, or excessive rain run-off onto the roof top.
- Assemble the structure as close to its final location as possible.
- It is recommended to wear safety gloves, safety glasses, and hard hats for installation.
- Do not hang from, climb on, or stand on the structure or roof.
- Before assembly, read instructions and check that all parts are present in the boxes. If any parts are missing, refer to warranty information.
- A 6ft (1.8m) stepladder, Phillips screwdriver, tape measure, level, mallet, and a tarp to place parts on will be required for assembly (not included).
- Remove top protective film from roof panels prior to assembly; DO NOT remove bottom protective film until ready to insert roof panels, so as to identify which side is on top.

**ANCHORING INSTRUCTIONS:**

- Proper anchoring of the frame to the base and the wall is required for safety.
- Any structure not anchored securely has the potential to fly away during high wind causing damage and safety hazard.
- How the item is anchored, and the hardware and tools required, will vary based upon the set-up location and are not provided.
- Please check with your local hardware store if for the appropriate anchors for your surface.
- Do not anchor to pavers / pavement slabs because they are not a solid foundation.
- Periodically check the anchors to ensure they remain secure

**CARE AND MAINTENANCE:**

- In case of a defective or damaged part, or for any other questions concerning the product, please contact the manufacturer directly.
- Please have the parts list and part numbers on hand when ordering or requesting replacement parts.

**ROOF PANELS:**

- Gently clean with an environmentally-friendly soap solution and water using a sponge or washcloth.
- Do not use abrasive materials, wire brushes, chemicals, harsh cleaners, or bleach.
- Rinse using a garden hose and air dry. If removed, ensure thoroughly dry prior to storage.
- Do not use pressure washer.

**STRUCTURE:**

- Gently clean with an environmentally-friendly soap solution and water using a sponge or washcloth.
- Do not use abrasive materials, wire brushes, chemicals, harsh cleaners, or bleach.
- Rinse using a garden hose and air dry.
- Do not use pressure washer.
- If there are nicks, chips, and/or scratches see the part # of the paint in the parts list to obtain a matching touch-up paint.

## MAINTENANCE NOTES

1. In case of a defective or damaged part, or for any other questions concerning the product, please contact the manufacturer directly.
2. Please have the parts list and part numbers on hand when ordering or requesting replacement parts.
3. The product should not be installed adjacent to trees or a sloped roof. Snow and ice may slide onto the roof and cause it to collapse.
4. While the product is designed to stay assembled year long, the roof must be kept free of accumulation of snow.



## ONE YEAR LIMITED WARRANTY

This product has been designed and manufactured to meet the highest standards of quality and durability. Subject to the Conditions for Exercising the Warranty and the Limitations on the Warranty set forth below, it is warranted to be free of material and manufacturing defects for a period of **one year** from the date of purchase. Missing and damage due to transportation is not covered by the manufacture warranty. Should the product become damaged, or the warranty period has expired, please contact Gazebo Penguin Customer Service Department for a complete schedule of replacement parts and prices.

## CONDITIONS FOR EXERCISING THE WARRANTY

The warranty only applies to the original purchaser with the bill.

In order to properly exercise your warranty, please comply with the following:

Carefully inspect the contents of the carton for missing or damaged components. Should you discover damaged or missing parts, **do not return the product to the place of purchase**, but contact Gazebo Penguin Customer Service Department at the numbers listed below:

**Montreal:** (514) 276-3485

**Elsewhere:** 1-800-737-7174

You can also find a claim form to fill out online:











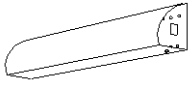

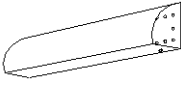

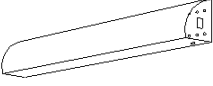

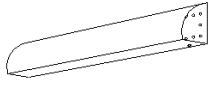

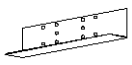

<https://abrispenguin.com/assemblyinstructions/>

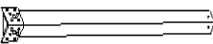

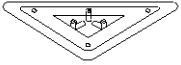





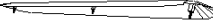
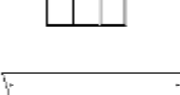



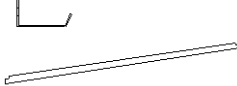



**NOTE: Damages/missing parts must be reported within 30 days of delivery. If claimed after your request might be rejected.**

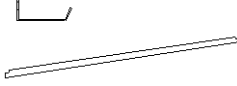













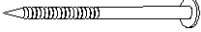

## LIMITATIONS ON THE WARRANTY

1. The product is not warranted against damages due to vandalism, abuse, falling or thrown objects, or accumulation of snow.
2. The product is not warranted against damages due to extreme weather conditions, such as thunderstorms, hail, strong wind or snow storms, or any other acts of God.
3. Leaking due to heavy rain may happen, please refer to the instruction manual for window positions and information on how to evacuate the water.
4. The product is only warranted in the event it is installed in accordance with the Gazebo Penguin's written instructions enclosed with the product.
5. The product is not warranted in the event it has been improperly anchored.
6. We reserve the right to replace or repair any defective product or parts at our discretion.
7. No change to the unit is allowed. This will void your warranty.

# 43226MR GAZEBO BROWN (see page 8 for Slate parts)

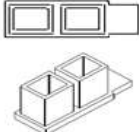

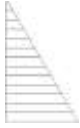
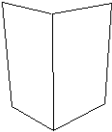

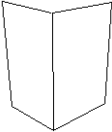

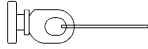
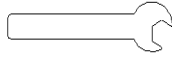



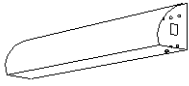

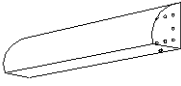

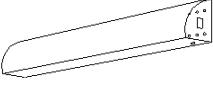

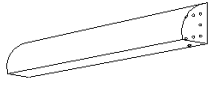

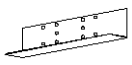

PART	PACKED IN BOX	QTY	DIAGRAM	PART	PACKED IN BOX	QTY	DIAGRAM
(11-626-22) 65 1/2" TOP LEFT BEAM A	3	2		(20-042-22) 85 1/2" CENTRAL HUB L	4	1	
(11-627-22) 65 1/2" TOP RIGHT BEAM B	3	2		(20-039-22) 92 5/8" ROOF RAFTER L1	4	4	
(11-688-22) 91" TOP LEFT BEAM C	3	2		(20-014-22) 60 3/8" ROOF RAFTER L2	4	2	
(11-689-22) 91" TOP RIGHT BEAM D	3	2		(20-036-22) 73 3/4" ROOF RAFTER L3	4	8	
(11-628-22) CORNER PLATE E	3	4		(20-072-22) FINISHING BAR M	4	2	
(11-629-22) CENTER PLATE F	3	4		(20-016-22) FINISHING BAR M1	4	6	
(11-630-22) 81 1/2" LEG G	3	4		(20-037-22) FINISHING BAR M2	4	2	
(11-631-22) FOOT PLATE H	3	4		(20-038-22) FINISHING BAR M3	4	2	
(11-632-22) CORNER COVER I	3	4		(20-073-22) FINISHING BAR M4	4	2	
(11-633-22) MIDDLE COVER J	3	4		(20-019-22) SOLIDIFYING BAR N2	4	6	
(11-690-22) 88" TOP CAP K	4	1		(20-031-22) SOLIDIFYING BAR N3	4	2	

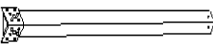
PART	PACKED IN BOX	QTY	DIAGRAM	PART	PACKED IN BOX	QTY	DIAGRAM
(20-032-22) SOLIDIFYING BAR N4	4	2		(20-060-22) SOLIDIFYING BAR BRACKET P2	4	4	
(20-034-22) SOLIDIFYING BAR N6	4	2		(20-070-22) 55 1/4" RIGHT FLASHING Q	4	4	
(20-035-22) SOLIDIFYING BAR N7	4	2		(17-053-22) FINISHING END Q1	4	8	
(12-030-22) MOUNTING BRACKET O	4	4		(19-097-22) CORNER BRACKET Q2	4	4	
(20-012-22) 60 3/8" COVER ROOF BAR O1	4	2		(20-071-22) 55 1/4" LEFT FLASHING R	4	4	
(20-040-22) 73 3/4" COVER ROOF BAR O2	4	8		(20-074-22) 26 3/4 " CENTER FLASHING S-1	4	2	
(20-041-22) 92 5/8" COVER ROOF BAR O3	4	4		(20-076-22) 76 1/2 " CENTER FLASHING S-3	4	2	
(12-031-22) MOUNTING BRACKET P	4	10		(11-692-22) 86" CURTAIN RAIL 16' SIDE T	4	4	
(18-067-22) SOLIDIFYING BAR BRACKET P1	4	10		(11-641-22) 60 1/2 " CURTAIN RAIL 12' SIDE U	4	4	

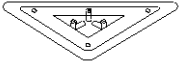

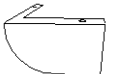



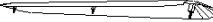
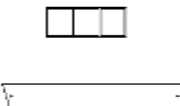





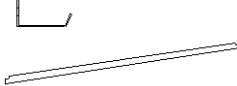



PART	PACKED IN BOX	QTY	DIAGRAM	PART	PACKED IN BOX	QTY	DIAGRAM
(20-023-22) LEFT LOWER ROOFPANEL, 16' SIDE V2	2	2		(20-0230-22) RIGHT UPPER ROOF PANEL, 12' SIDE X5	1	2	
(20-024-22) RIGHT LOWER ROOF PANEL, 16' SIDE V3	2	2		(08-158-22) BOLT Pp	3	264	 (M6x16mm)
				(08-156-22) SCREW Qq	3	126	 (M4x16mm)
(20-025-22) LEFT LOWER ROOF PANEL, 12' SIDE V4	2	2		(08-167-22) SCREW Rr	3	12	 (M6x63.5mm)
(20-026-22) LEFT LOWER ROOF PANEL, 12' SIDE V5	2	2		(08-193-22) PLASTIC PLUG Ss	3	12	
(20-022-22) MIDDLE LOWER ROOF PANEL 25"X40" W1	1	6		(08-187-22) WASHER Tt	3	16	 (M6)
(20-028-22) MIDDLE UPPER ROOF PANEL 25"X36.5" Y1	1	6		(11-697-22) CURTAIN RAIL CAP Uu	3	8	
(20-027-22) LEFT UPPER ROOF PANEL, 16' SIDE X2	1	2		(08-189-22) ACORN NUT Vv	3	4	
(20-024-22) RIGHT UPPER ROOF PANEL, 16' SIDE X3	1	2		(11-693-22) SCREEN/ MOUSTIQUAIRE Ww	4	2 Left	
						2 Right	
(20-029-22) LEFT UPPER ROOF PANEL, 12' SIDE X4	1	2		(11-694-22) PRIVACY CURTAIN Xx	4	2 Left	
						2 Right	

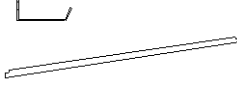











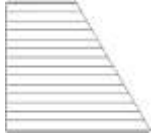

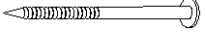
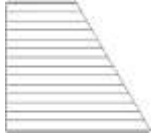

PART	PACKED IN BOX	QTY	DIAGRAM	*NOT INCLUDED IN THE BOX		
				DESCRIPTION	COLOUR	PART #
(16-118-22) SCREW M6x36 Oo1	3	62		SPRAY PAINT	BROWN	11-726
				PAIN T PEN		18-184
(11-705-22) CURTAIN HOOKS	3	112				
(08-182) 10 mm KEY	3	1				

# 43226MR GAZEBO SLATE

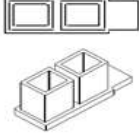
PART	PACKED IN BOX	QTY	DIAGRAM	PART	PACKED IN BOX	QTY	DIAGRAM
(11-626-32) 65 1/2" TOP LEFT BEAM A	3	2		(20-042-32) 85 1/2" CENTRAL HUB L	4	1	
(11-627-32) 65 1/2" TOP RIGHT BEAM B	3	2		(20-039-32) 92 5/8" ROOF RAFTER L1	4	4	
(11-688-32) 91" TOP LEFT BEAM C	3	2		(20-014-32) 60 3/8" ROOF RAFTER L2	4	2	
(11-689-32) 91" TOP RIGHT BEAM D	3	2		(20-036-32) 73 3/4" ROOF RAFTER L3	4	8	
(11-628-32) CORNER PLATE E	3	4		(20-072-32) FINISHING BAR M	4	2	
(11-629-32) CENTER PLATE F	3	4		(20-016-32) FINISHING BAR M1	4	6	
(11-630-32) 81 1/2" LEG G	3	4		(20-037-32) FINISHING BAR M2	4	2	
(11-631-32) FOOT PLATE H	3	4		(20-038-32) FINISHING BAR M3	4	2	
(11-632-32) CORNER COVER I	3	4		(20-073-32) FINISHING BAR M4	4	2	
(11-633-32) MIDDLE COVER J	3	4		(20-019-32) SOLIDIFYING BAR N2	4	6	
(11-690-32) 88" TOP CAP K	4	1		(20-031-32) SOLIDIFYING BAR N3	4	2	

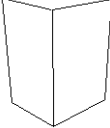

PART	PACKED IN BOX	QTY	DIAGRAM	PART	PACKED IN BOX	QTY	DIAGRAM
(20-032-32) SOLIDIFYING BAR N4	4	2		(20-060-32) SOLIDIFYING BAR BRACKET P2	4	4	
(20-034-32) SOLIDIFYING BAR N6	4	2		(20-070-32) 55 1/4" RIGHT FLASHING Q	4	4	
(20-035-32) SOLIDIFYING BAR N7	4	2		(17-053-32) FINISHING END Q1	4	8	
(12-030-32) MOUNTING BRACKET O	4	4		(19-097-32) CORNER BRACKET Q2	4	4	
(20-012-32) 60 3/8" COVER ROOF BAR O1	4	2		(20-071-32) 55 1/4" LEFT FLASHING R	4	4	
(20-040-32) 73 3/4" COVER ROOF BAR O2	4	8		(20-074-32) 26 3/4 " CENTER FLASHING S-1	4	2	
(20-041-32) 92 5/8" COVER ROOF BAR O3	4	4		(20-076-32) 76 1/2 " CENTER FLASHING S-3	4	2	
(12-031-32) MOUNTING BRACKET P	4	10		(11-692-32) 86" CURTAIN RAIL 16' SIDE T	4	4	
(18-067-32) SOLIDIFYING BAR BRACKET P1	4	10		(11-641-32) 60 1/2 " CURTAIN RAIL 12' SIDE U	4	4	

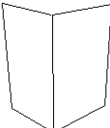
PART	PACKED IN BOX	QTY	DIAGRAM	PART	PACKED IN BOX	QTY	DIAGRAM
(20-023-32) LEFT LOWER ROOFPANEL, 16' SIDE V2	2	2		(20-0230-32) RIGHT UPPER ROOF PANEL, 12' SIDE X5	1	2	
(20-024-32) RIGHT LOWER ROOF PANEL, 16' SIDE V3	2	2		(08-158-32) BOLT Pp	3	264	 (M6x16mm)
				(08-156-32) SCREW Qq	3	126	 (M4x16mm)
(20-025-32) LEFT LOWER ROOF PANEL, 12' SIDE V4	2	2		(08-167-32) SCREW Rr	3	12	 (M6x63.5mm)
(20-026-32) LEFT LOWER ROOF PANEL, 12' SIDE V5	2	2		(08-193-32) PLASTIC PLUG Ss	3	12	
(20-022-32) MIDDLE LOWER ROOF PANEL 25"X40" W1	1	6		(08-187-32) WASHER Tt	3	16	 (M6)
(20-028-32) MIDDLE UPPER ROOF PANEL 25"X36.5" Y1	1	6		(11-697-32) CURTAIN RAIL CAP Uu	3	8	
(20-027-32) LEFT UPPER ROOF PANEL, 16' SIDE X2	1	2		(08-189-32) ACORN NUT Vv	3	4	
(20-024-32) RIGHT UPPER ROOF PANEL, 16' SIDE X3	1	2		(11-693-32) SCREEN/ MOUSTIQUAIRE Ww	4	2 Left	
						2 Right	
(20-029-32) LEFT UPPER ROOF PANEL, 12' SIDE X4	1	2		(11-694-32) PRIVACY CURTAIN Xx	4	2 Left	
						2 Right	

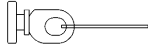
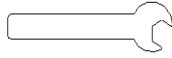
PART	PACKED IN BOX	QTY	DIAGRAM	*NOT INCLUDED IN THE BOX		
				DESCRIPTION	COLOUR	PART #
(16-118-32) SCREW M6x36 Oo1	3	62		SPRAY PAINT	SLATE	18-125
				PAIN T PEN		18-126
(11-705-32) CURTAIN HOOKS	3	112				
(08-182) 10 mm KEY	3	1				

## Before You Assemble the Gazebo

- Please don't destroy boxes until completely assembled.
- For future reference, take pictures of all six sides of each of the boxes upon receipt.
- Please verify the content of each box against the list of parts.
- It is important that this gazebo be anchored on a solid base with the provided screws. Otherwise, please ensure that you use anchors sufficient for your surface.
- The gazebo should not be installed adjacent to trees or a sloped roof. Snow and ice may slide onto the gazebo and cause it to collapse.

### Tools required (not provided)

- 6ft (1.8m) Stepladder
- Robinson #2 Screwdriver
- Mallet
- Tarp or protective material for placing parts on during assembly
- Tape Measure
- Leveling Shim
- Safety Gloves & Glasses

### Step 1:

1. Assemble Beams "A" and "B" using Center Plate "F", by sliding it inside the beams and securely tighten with 10 Bolts "Pp". Repeat with Beams "C" and "D", also using Center Plate "F".
2. Lay out the assembled Beams in a rectangle and join at each corner with a Corner Plate "E", by sliding it inside the beams and tighten it with 4 Bolts "Pp" tightly and hand fasten remaining 4 Bolts in pink. – see image on pg. 9

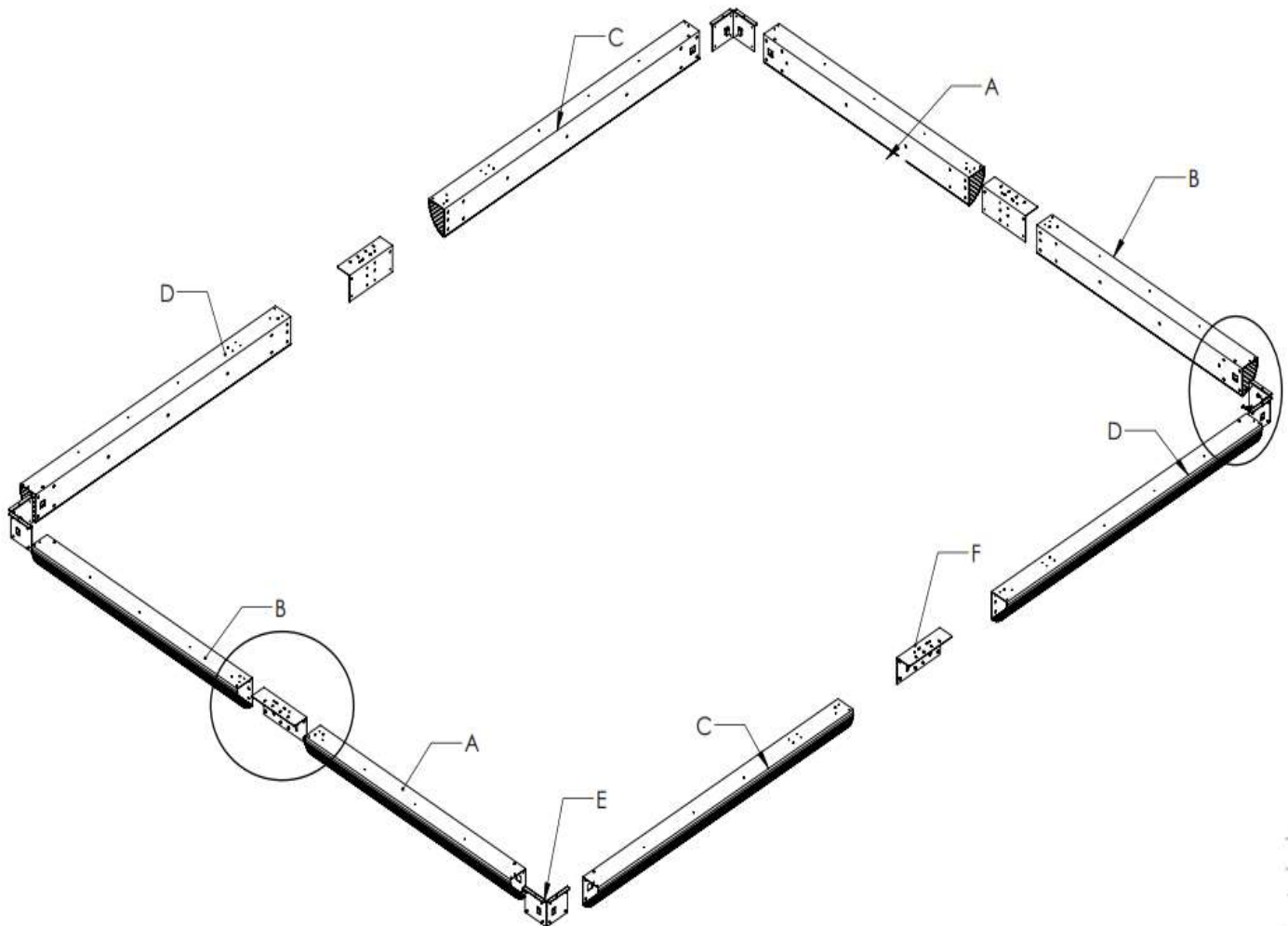

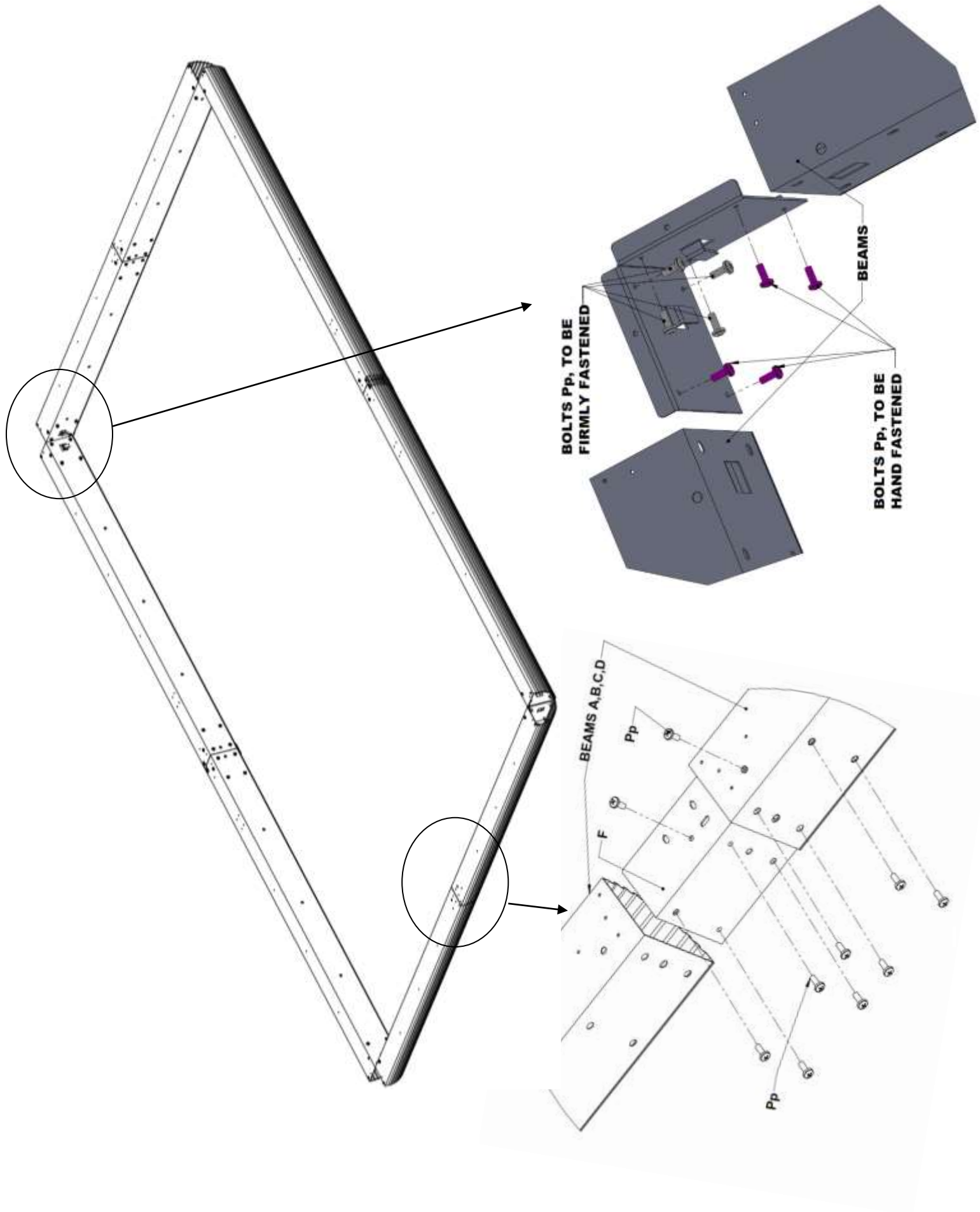

**Step 2:**

1. For each Leg "G", attach Foot Plate "H" using 3 Bolts "Pp".

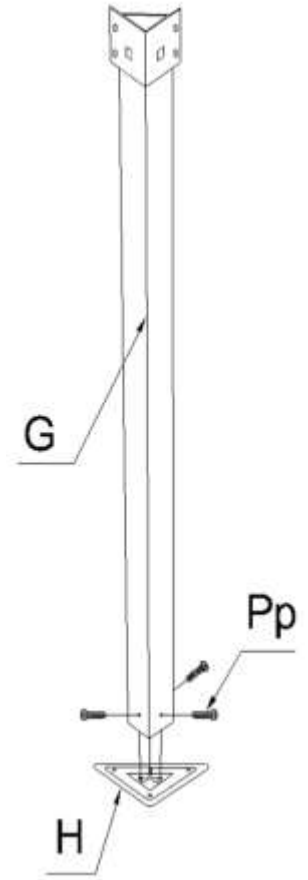

**Step 3:**

1. Unscrew 4 Pp Bolts as shown below, have someone lift the Beam assembly and attach each Leg "G" into a Corner, again securing each using 4 Bolts "Pp".
2. Repeat until all four Legs are in place.

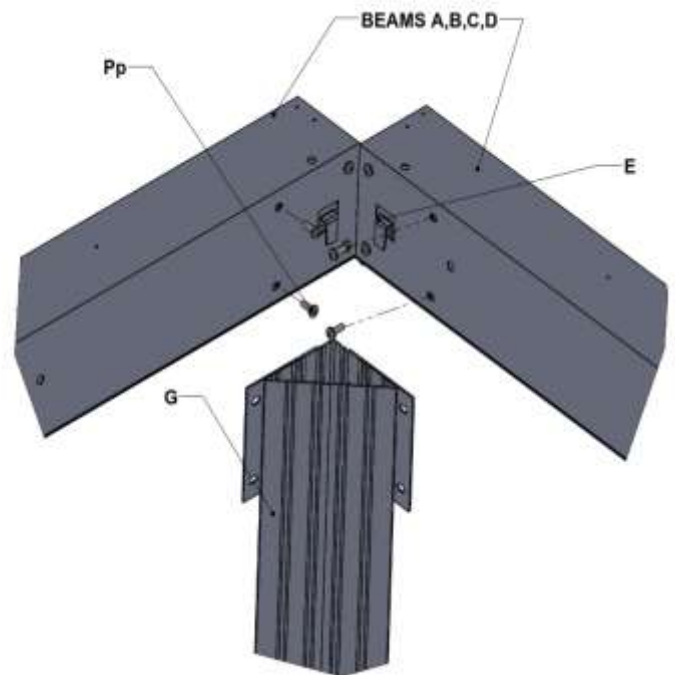
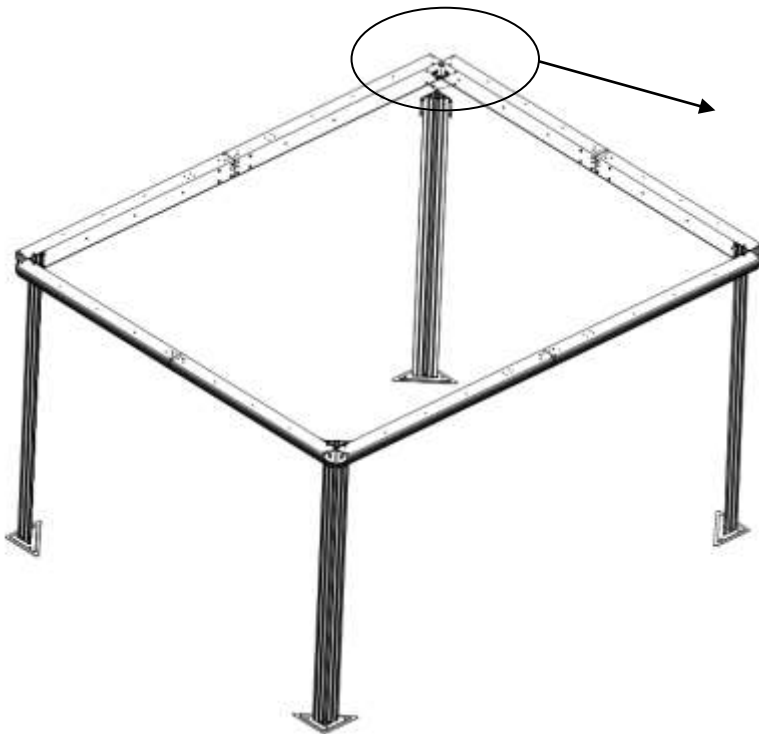

**Step 4:**

1. Install Middle Cover "J" at each of the 4 beam junctions, using 4 Screws "Qq" each.
2. Install Corner Cover "I" at each of the corners, using 4 Screws "Qq" each.

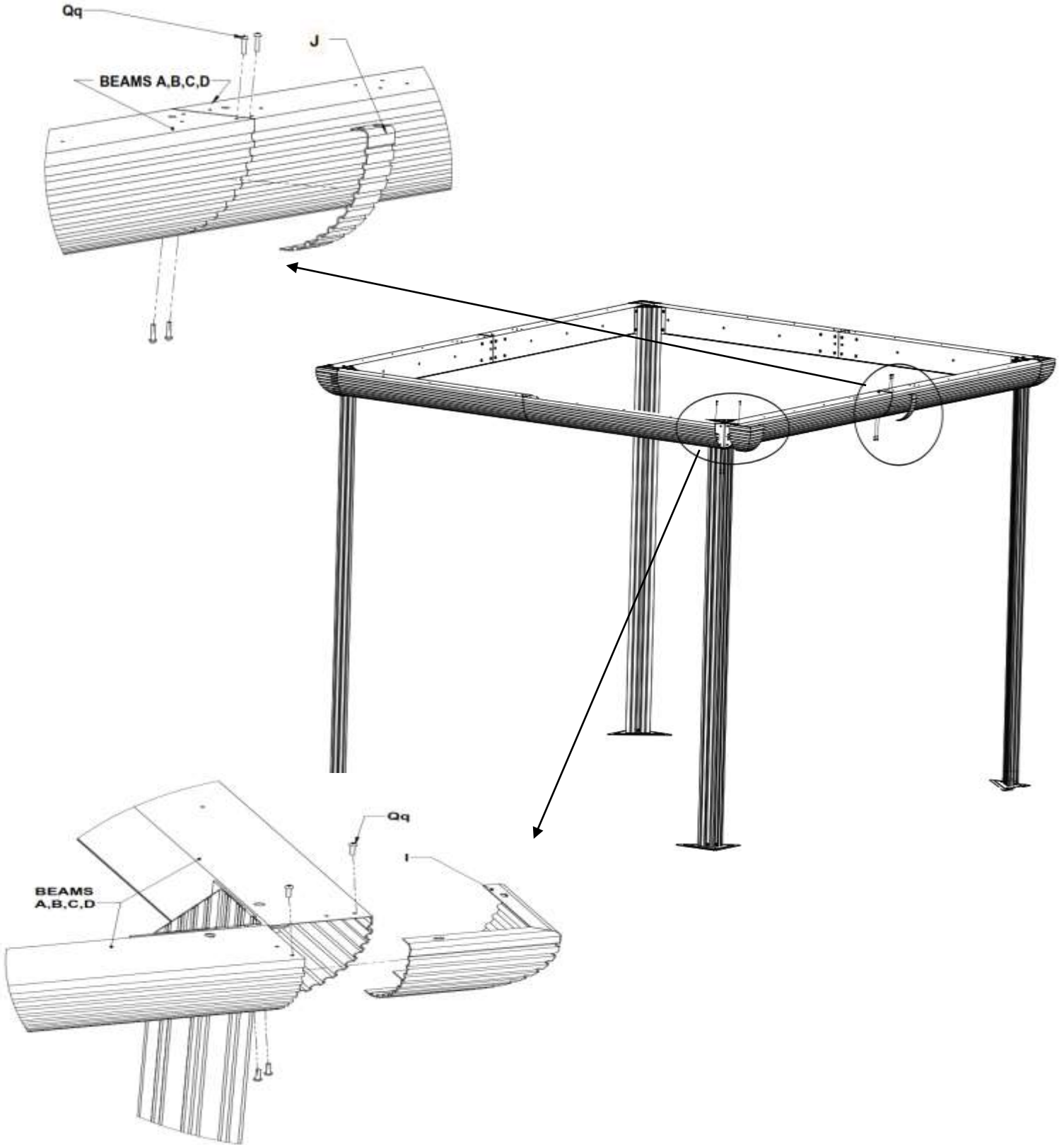

## Step 5:

1. Screw Mounting Bracket (O) to Rafter (L1) and Bracket (P) to Rafter (L2, L3) using the second last insert from under the rafter using Bolt (Pp).
2. Attach Roof Rafters (L1, L2, L3) to the Central Hub (L) using Bolt (Pp).
3. Use Screws (Qq) to affix the Rafters (L2, L3) onto the top of the structure going through the Mounting Brackets (P) attached to the Rafters.
4. Then, use Bolts (Pp) to affix the Rafters (L1) onto the top of the structure going through the Mounting Brackets (O) attached to the Rafters.

**Note: Rafters must be affixed where hole screws are closer to the center.**

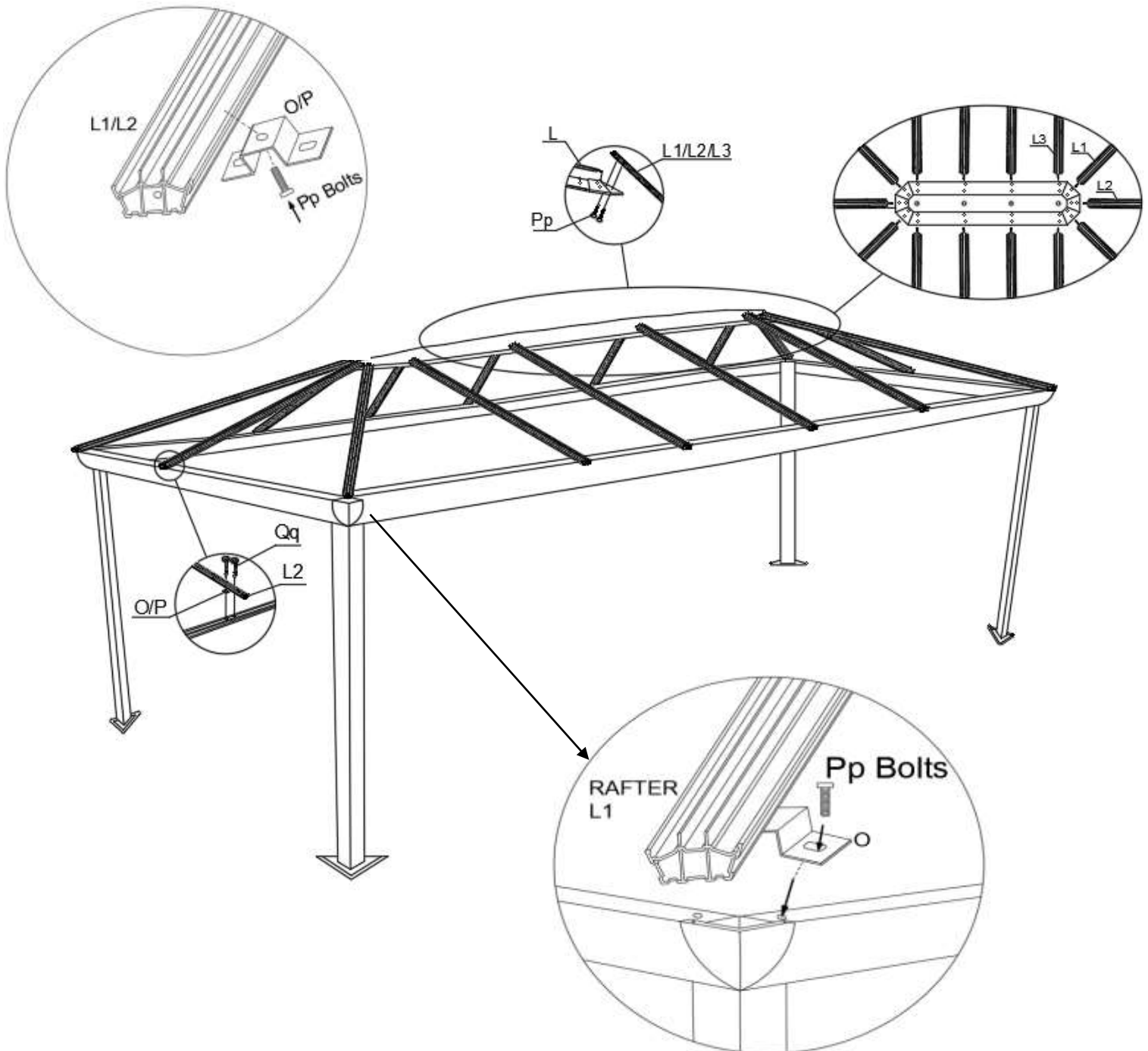



Step 6:

1. Install the Flashings “Q”, “R”, “S”, and “S-1” onto the beam assembly, using screws “Qq” on the inside. The notched end of a flashing will always go in a corner of the gazebo.

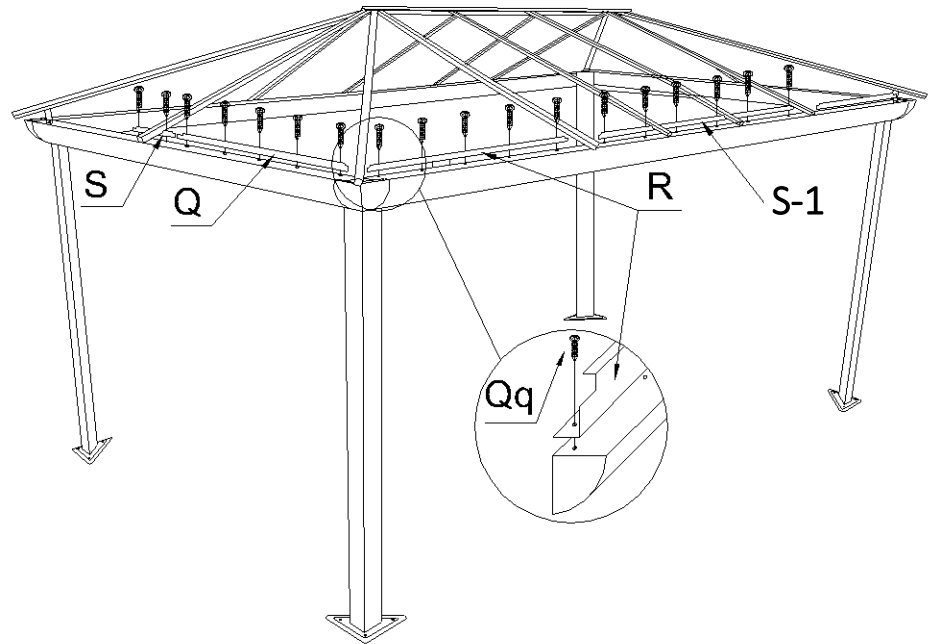

Step 7:

1. Install the curtain rails “T” and “U” on the inside of the beam assembly using bolts “Pp”.

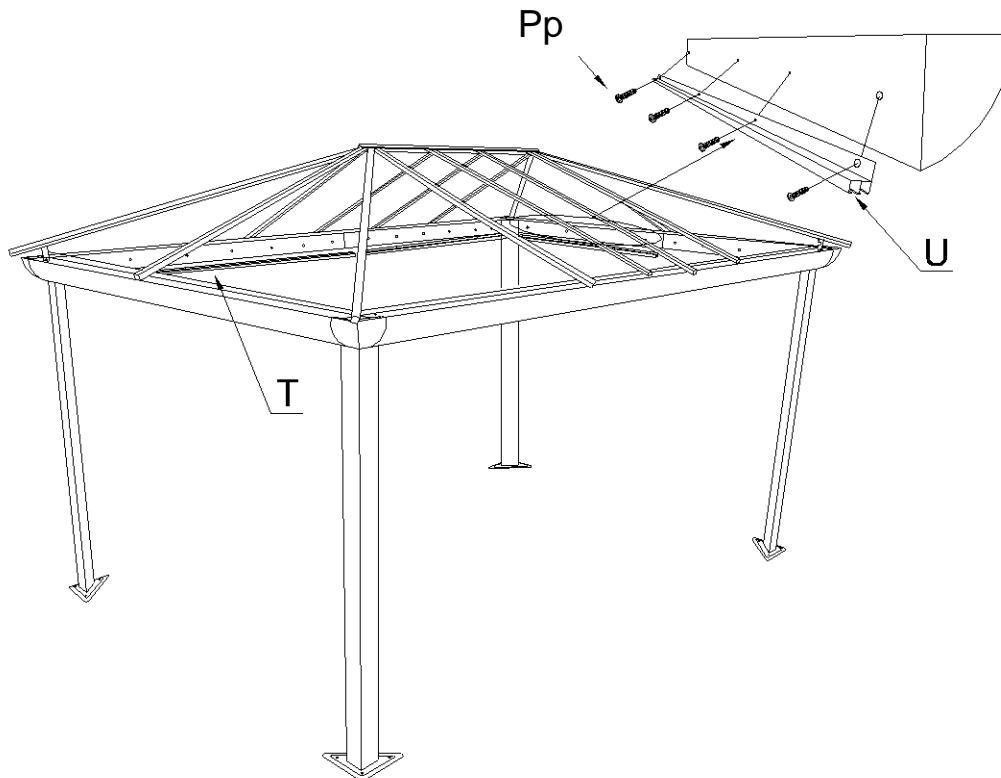

### Step 8:

1. Place Finishing Bars (M, M1, M2, M3, M4) next to each other and align the pre-drilled holes in each bar one on top of the other.
2. Place Finishing End & Corner Bracket (Q1, Q2) over the aligned holes and secure with Bolts (Pp).
3. Repeat process with all Finishing Bars as illustrated.
4. In order to finish the installation of the last Finishing Bar (M) you have to unscrew the first Bolts (Pp) at your starting point and place (Q1, Q2) then re-install the Bolt (Pp).

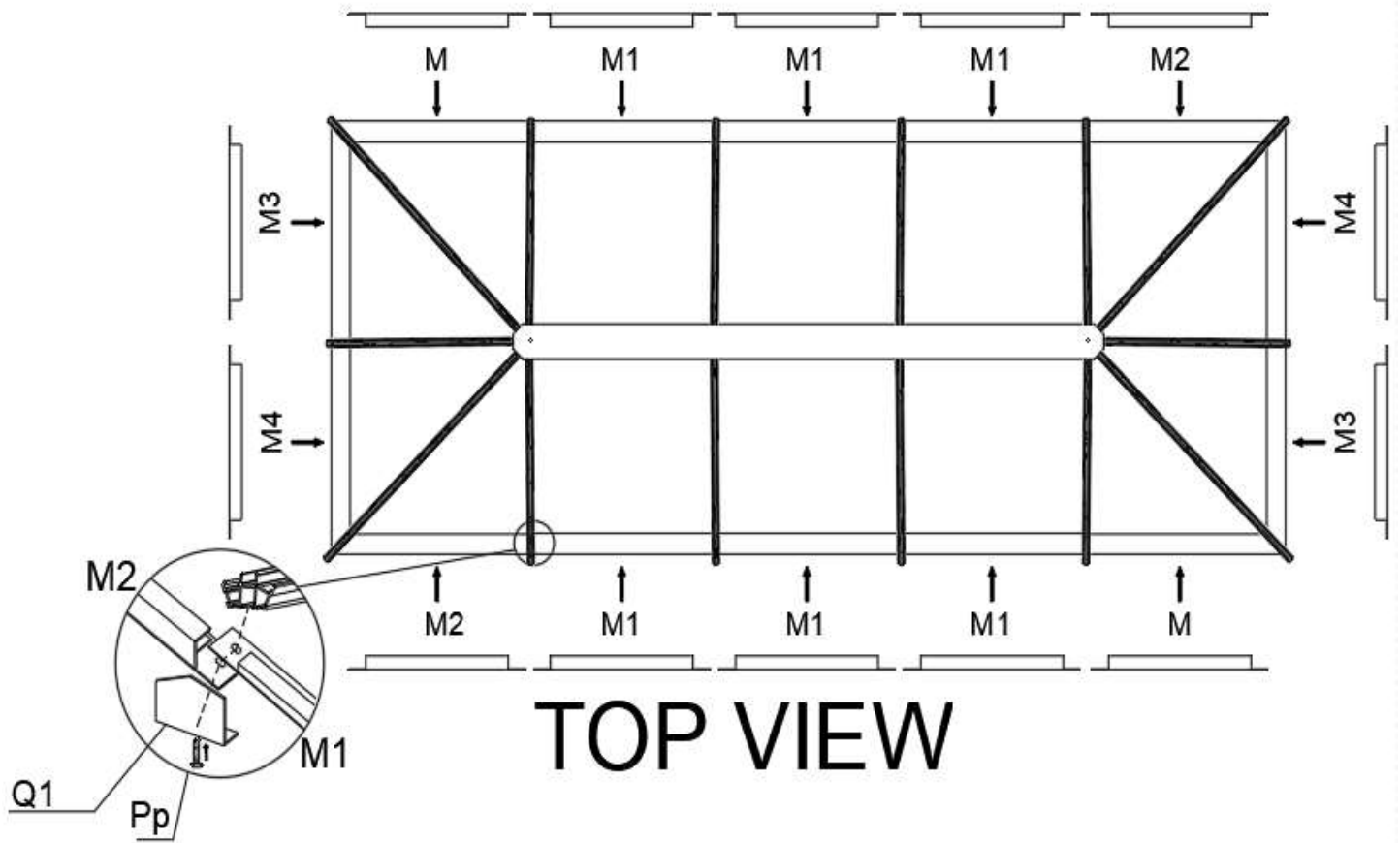

**Step 9:**

1. From the inside of the solarium, install the Solidifying Bar (N2, N3, N4, N6, N7) as illustrated using the Bolts (Pp).
2. Each Bolt (Pp) must be inserted into the inserts of the Rafters.

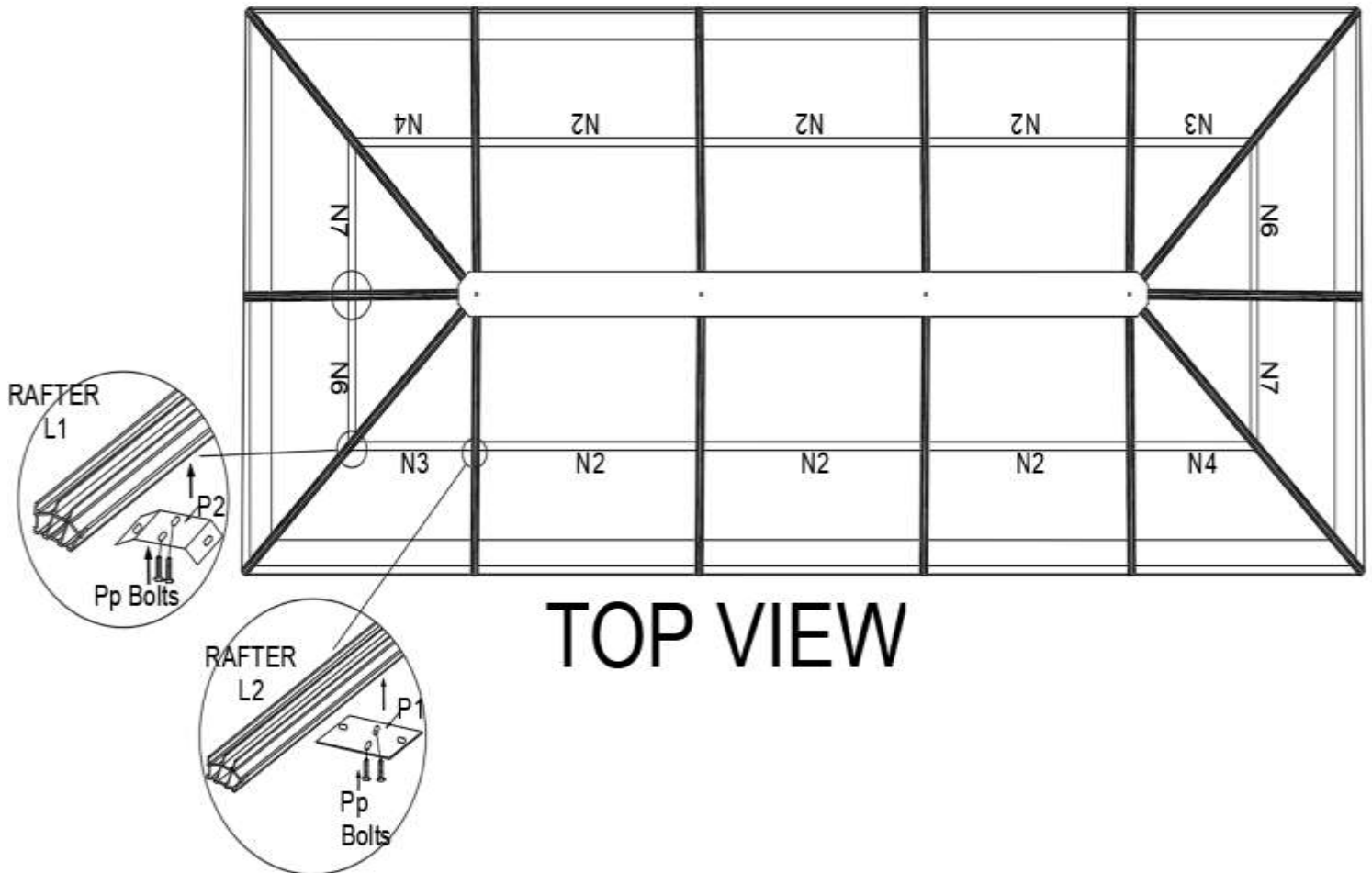

**Step 10:**

Install the Bottom Roof Panels (W1, V2, V3, V4, V5) by sliding them onto Finishing Bars (M, M1, M2, M3, M4).

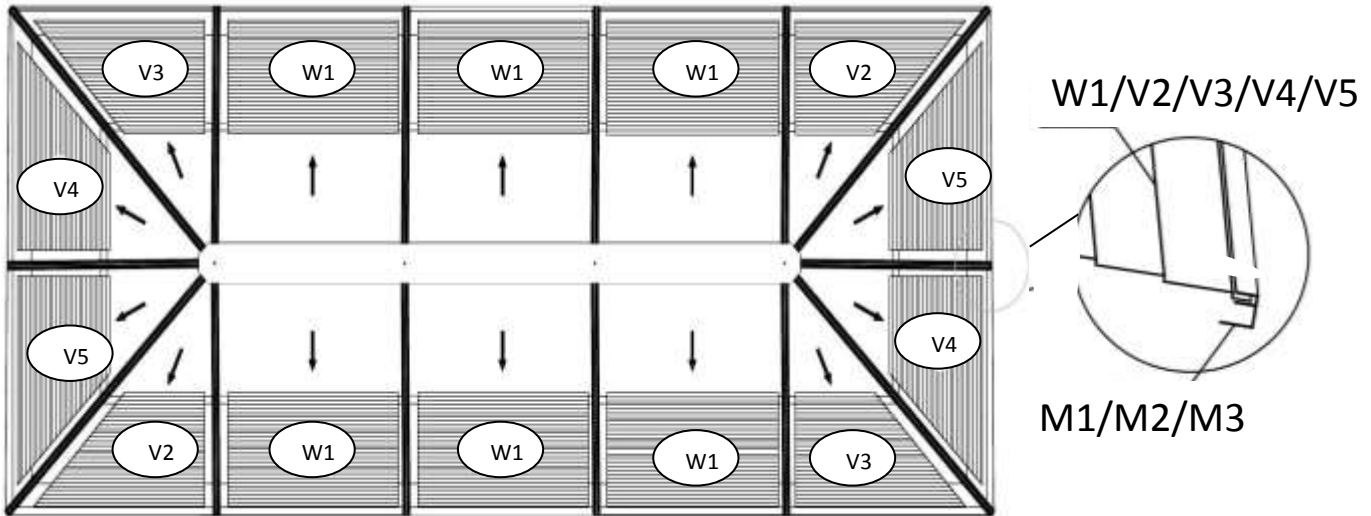

**TOP VIEW**

**Step 11:**

Install First Upper Roof Panel (Y1) by sliding it on top of Rafters (L1, L2, L3).

**Note: Roof Panel must be held in place until it is secured with the Cover Roof Bar.**

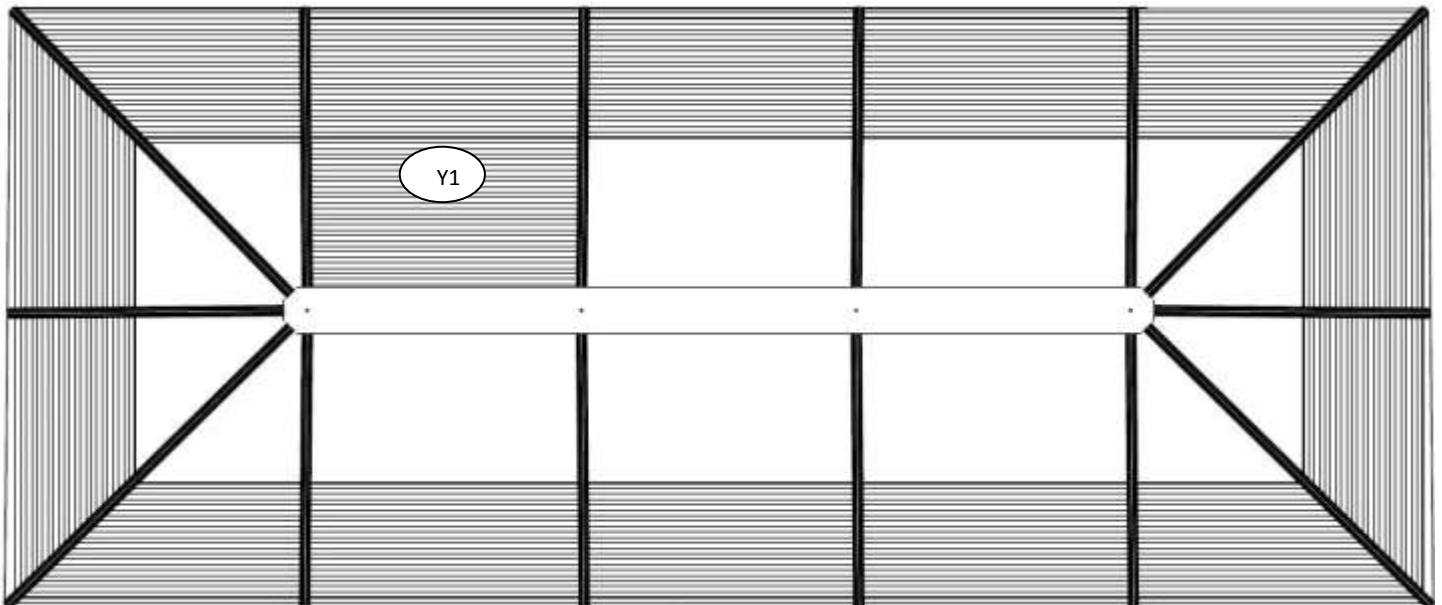

**Step 12:**

1. Once the installation of the panel is complete, install a Cover Roof Bar (O1, O2, O3) onto the Rafter (L1, L2, L3) with the help of bolts (Oo1).
2. Place Cover Roof Bar on top of Rafter, but do not completely screw it until both panels connected to the Rafter are placed.

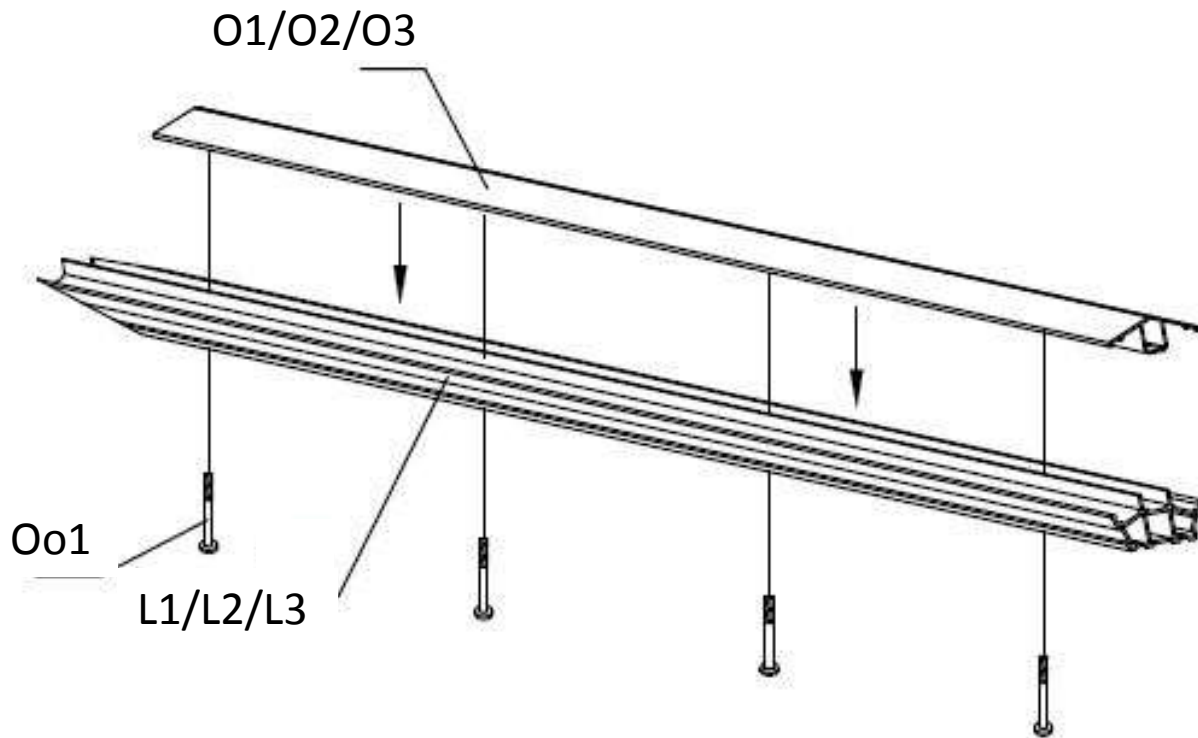

**Step 13:**

1. Install the next upper roof panel (X3) by sliding it on top of roof rafters (L1, L2, L3) then secure.
2. Continue to install the other panels one at the time until the last section.

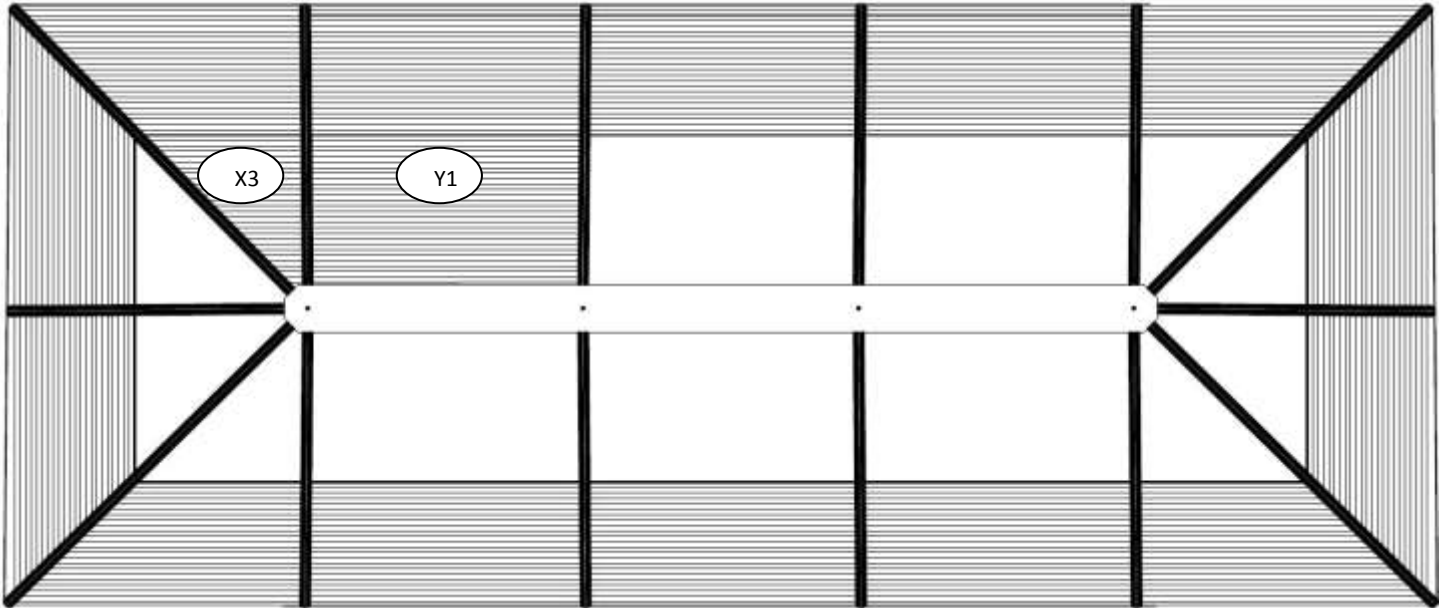

**Step 14:**

Before installing last Upper Roof Panel, put Cap (K) on top of the Central Hub (L)



**Step 15:**

Install the last Upper Roof Panel (Y1).

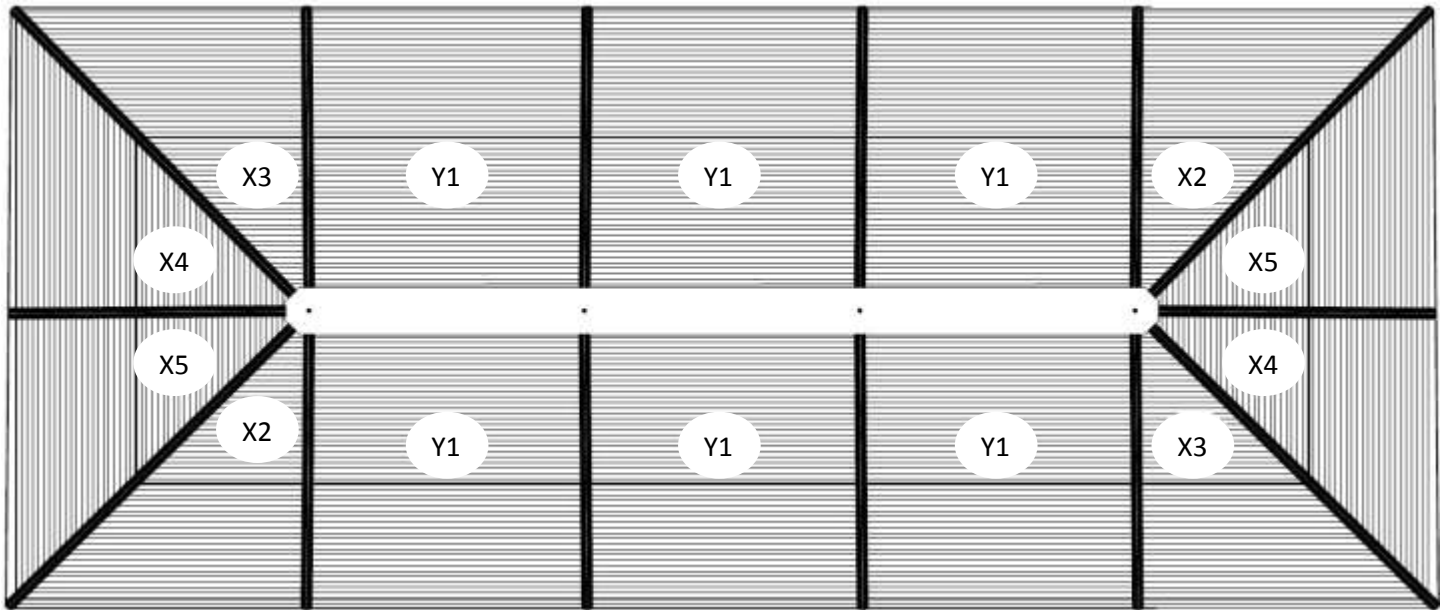

**TOP VIEW**



**Step 16:**

Once the last Roof Panel is installed, screw last Cover Roof Bar (O1, O2, O3) to the roof bars (L1, L2, L3) with bolt (Oo1).

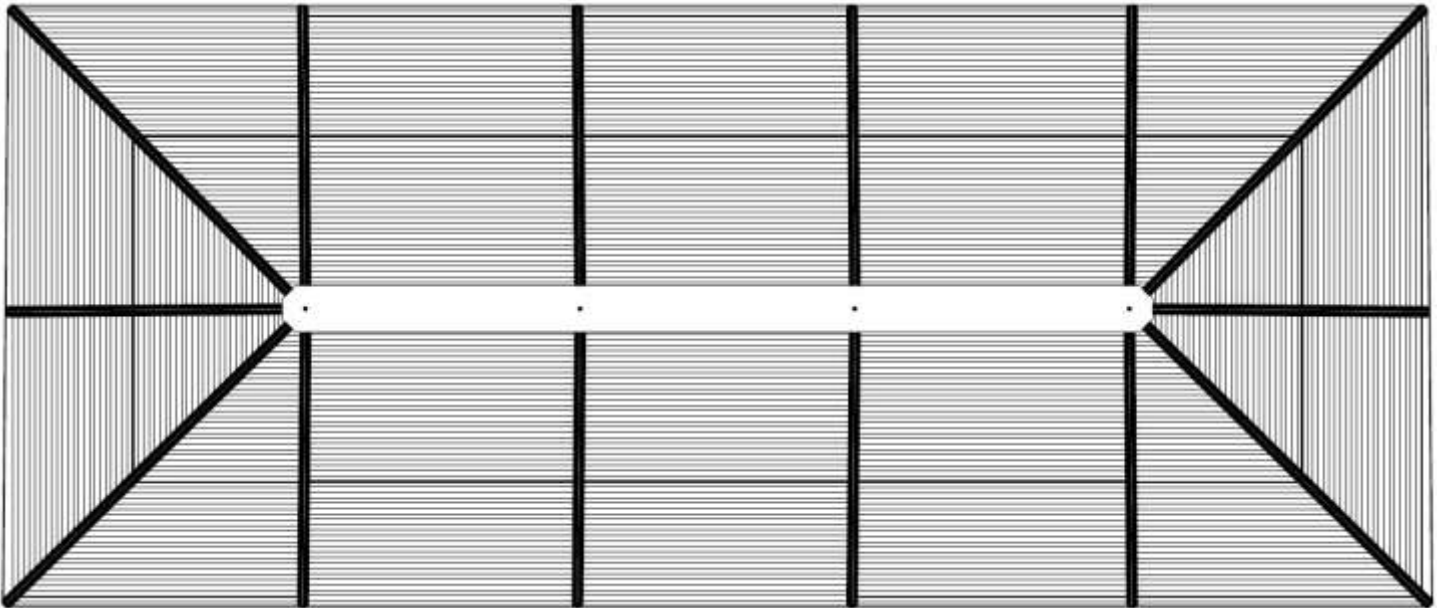
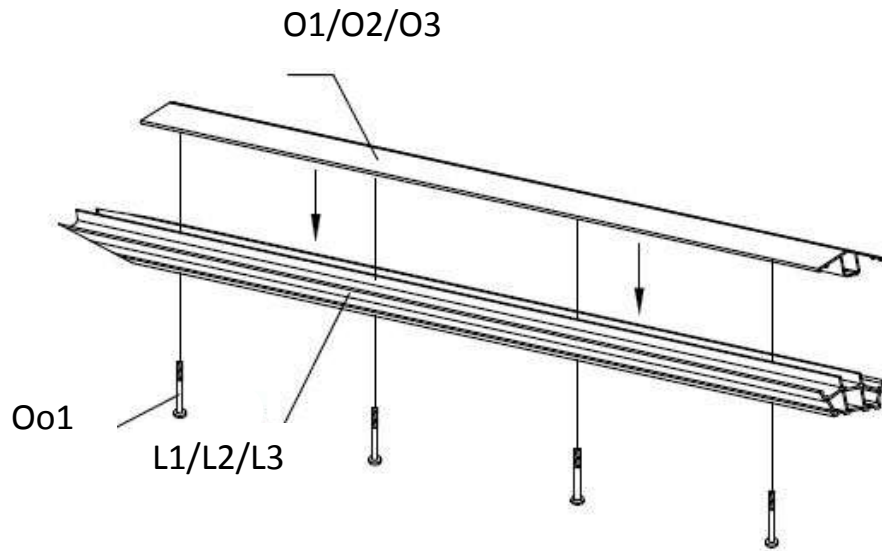

**Step 17:**

Use Nut (Vv) to affix Top Cap (K) to the Central Hub (L).

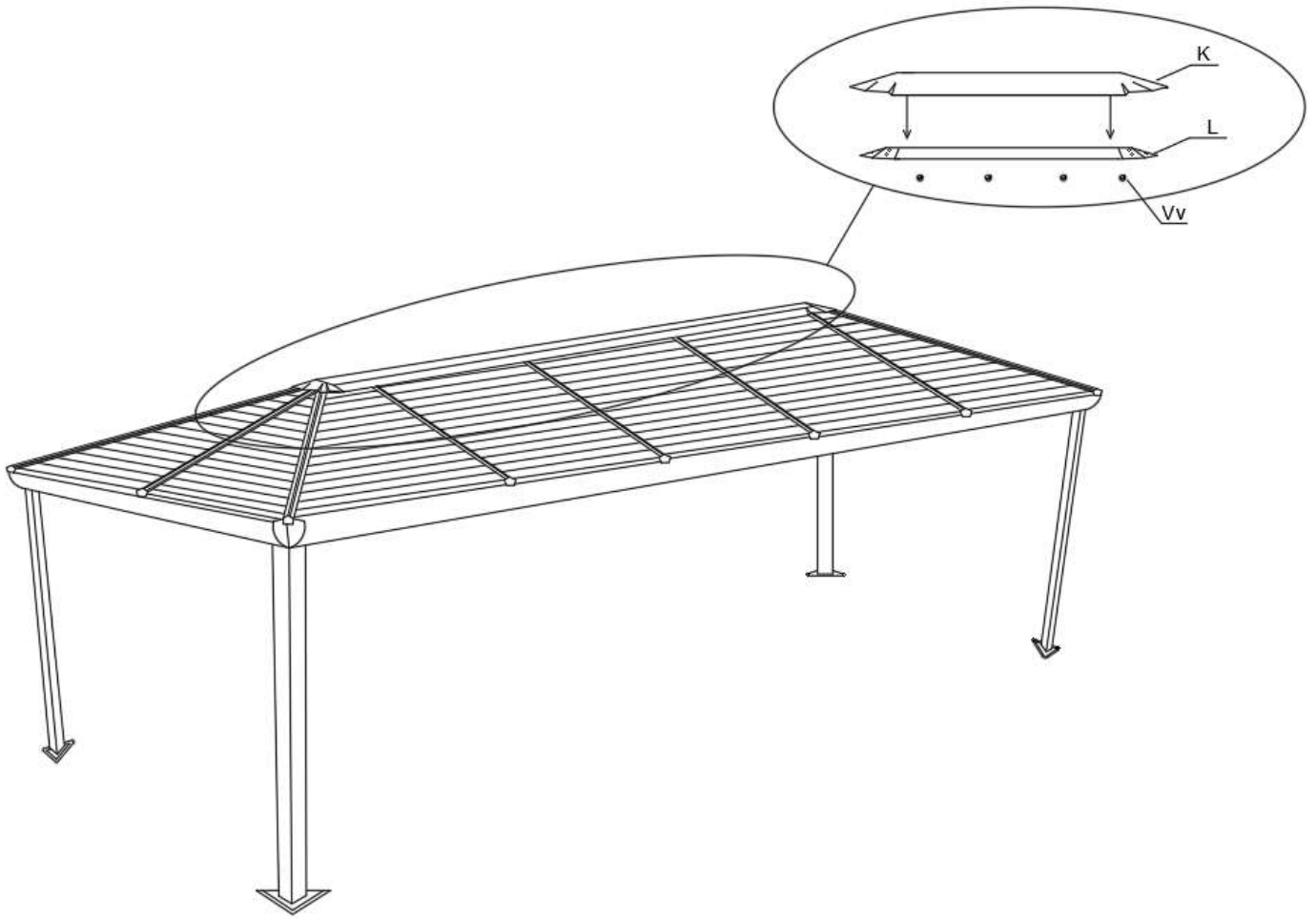

**Step 18:**

1. Secure each Foot Plate into the ground using Screws “Rr” and Washers “Tt”.
2. Use lag Shields (Ss) if needed for harder surfaces.

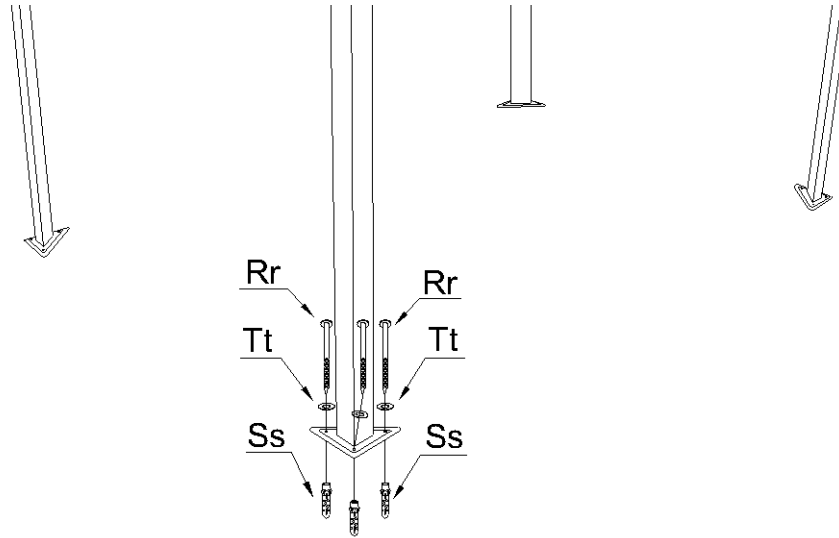

**Step 19:**

1. Install the Screen Curtains “Ww” in the interior groove of the curtain rails, using the provided Hooks. Install the Privacy Curtains “Xx” in the Exterior Groove of the rails. The Curtains and Screen Panels facing diagonally to each other will be same.
2. Once the Hooks are in, use Curtain Rail Caps “Uu” to close ends of Curtain Rails.

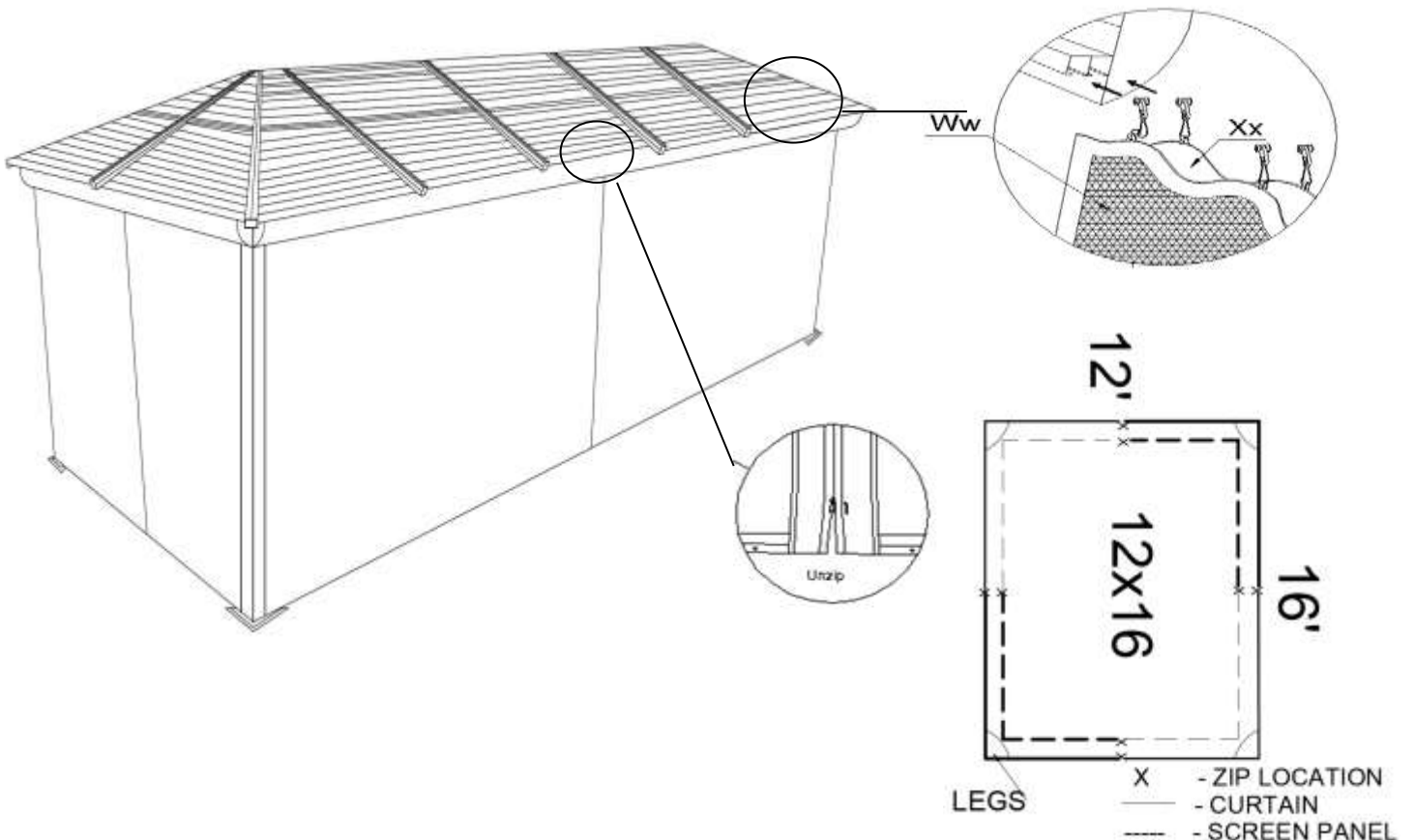

**NOTE: The Dimensions Are Approximate.**

43226 GAZEBO  
PLAN A LA BASE DES PATTES  
PLAN AT BASE OF LEGS

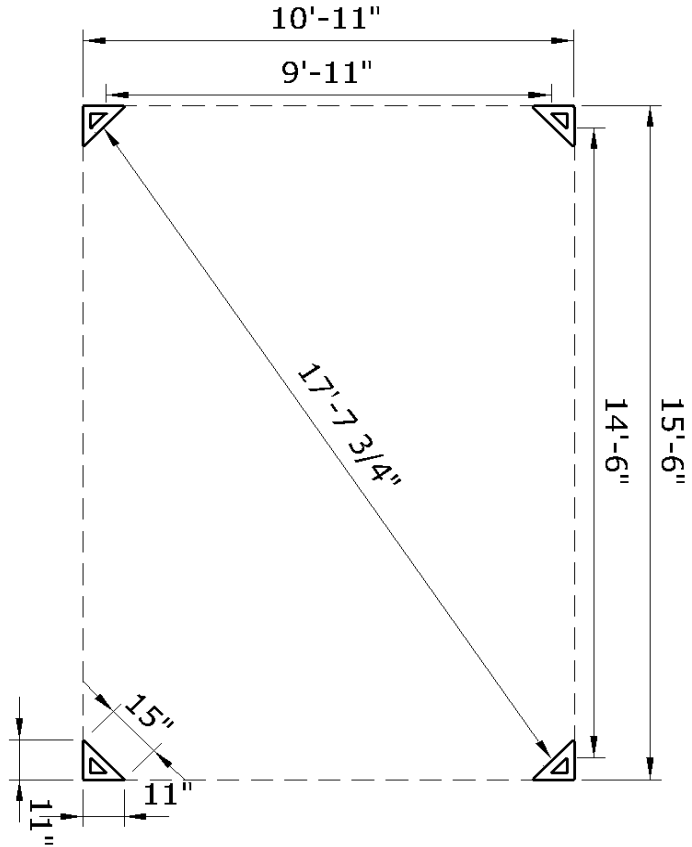

43226 GAZEBO  
REBORD DU TOIT  
ROOF OVERHANG

