



**GAZEBO  
Penguin inc.**

4660 HICKMORE ST.  
MONTREAL, QUEBEC  
H4T 1K2  
TEL: 1-514-276-3485, 1-800-737-7174  
Email: customerservice@gazebopenguin.com

41212MR-12 SAND  
41212MR-32 SLATE

**PLEASE, READ  
IN ITS ENTIRETY  
BEFORE  
INSTALLATION**

**12 X 12 SOLARIUM  
ASSEMBLY INSTRUCTIONS**

**PLEASE, READ  
IN ITS ENTIRETY  
BEFORE  
INSTALLATION**

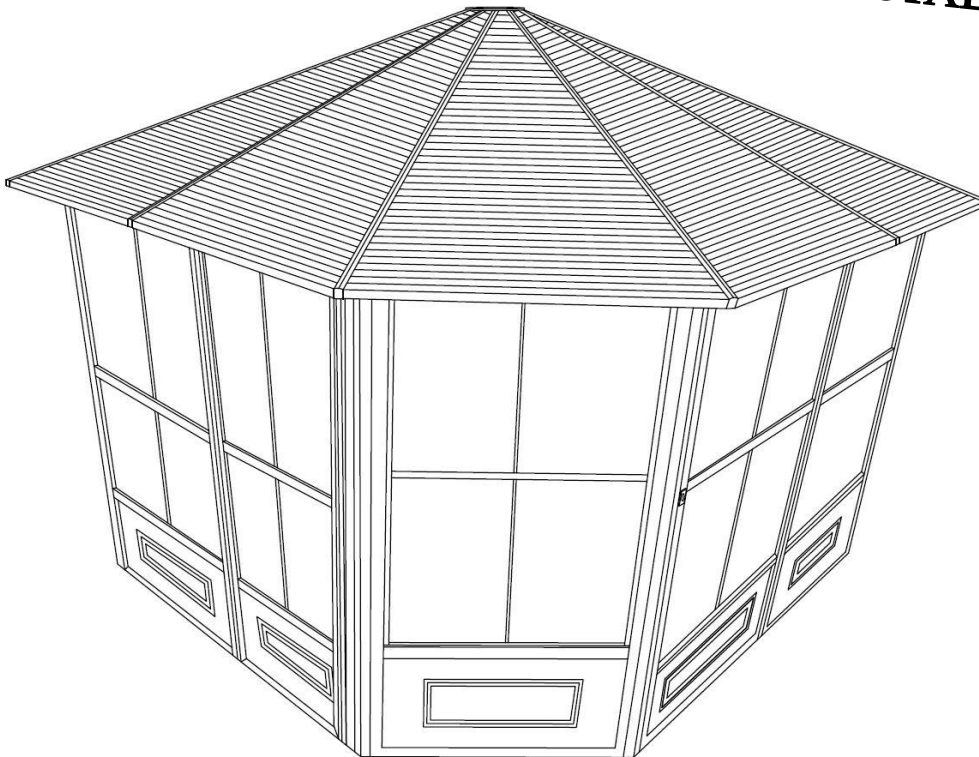

**DO NOT DESTROY THE BOXES UNTIL COMPLETELY ASSEMBLED  
PLEASE VERIFY THE CONTENT OF EACH BOX AGAINST THE LIST OF PARTS**

Two or more adults required for assembly

Base Dimensions 12' ½" x 12' ½"  
Largest Dimensions 12'10"x12'10"  
Overall Height 110" } APPROX. }

**DO NOT DESTROY THE BOXES UNTIL COMPLETELY ASSEMBLED  
PLEASE VERIFY THE CONTENT OF EACH BOX AGAINST THE LIST OF PARTS**

**12ft x 12ft / 3.66m x 3.66m Solarium**

**Instruction Manual**

**IMPORTANT: RETAIN FOR FUTURE REFERENCE, READ CAREFULLY**

**Consult with your local governing authority / local municipal codes regarding installation of temporary structures before purchase or assembly. Some jurisdictions may require permits for, or otherwise regulate, installation and use.**

For assistance with assembly, installation, parts, or customer service, contact Gazebo Penguin Customer Service Department at the numbers listed below (English & French, Mon-Fri 8:00 AM to 4:00 PM EST):

**Montreal:** (514) 276-3485

**Elsewhere in Canada and the US:** 1-800-737-7174

**WARNING:**

- For outdoor use.
- Snow should be regularly cleared from the roof and not allowed to accumulate.
- Retain your **proof of purchase** for warranty purposes. Also keep the **original boxes** until the installation is complete and correct.
- The unit may take more than 4 hours and 3 people are required for this assembly.

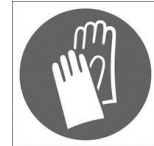

**PRIOR TO ASSEMBLY:**

- Please don't destroy boxes until completely assembled.
- The foundation must be level, flat, and solid, such as concrete or asphalt.
- Keep away from overhead utility lines, tree branches, and other structures.
- Check for underground pipes or wires if digging or drilling is required.
- Do not install near roof lines or other structures that could shed snow, ice, or excessive rain run-off onto the roof top.
- Assemble the structure as close to its final location as possible.
- It is recommended to wear safety gloves, safety glasses, and hard hats for installation.
- Do not hang from, climb on, or stand on the structure or roof.
- Before assembly, read instructions and check that all parts are present in the boxes. If any parts are missing, refer to warranty information.
- A 6ft (1.8m) stepladder, Phillips screwdriver, tape measure, level, mallet, and a tarp to place parts on will be required for assembly (not included).
- Remove top protective film from roof panels prior to assembly; DO NOT remove bottom protective film until ready to insert roof panels, so as to identify which side is on top.

**ANCHORING INSTRUCTIONS:**

- Proper anchoring of the frame to the base and the wall is required for safety.
- Any structure not anchored securely has the potential to fly away during high wind causing damage and safety hazard.
- How the item is anchored, and the hardware and tools required, will vary based upon the set up location and are not provided.
- Please check with your local hardware store if for the appropriate anchors for your surface.
- Do not anchor to pavers / pavement slabs because they are not a solid foundation.
- Periodically check the anchors to ensure they remain secure

**CARE AND MAINTENANCE:**

- In case of a defective or damaged part, or for any other questions concerning the product, please contact the manufacturer directly.
- Please have the parts list and part numbers on hand when ordering or requesting replacement parts.

**ROOF PANELS:**

- Gently clean with an environmentally-friendly soap solution and water using a sponge or washcloth.
- Do not use abrasive materials, wire brushes, chemicals, harsh cleaners, or bleach.
- Rinse using a garden hose and air dry. If removed, ensure thoroughly dry prior to storage.
- Do not use pressure washer.

**STRUCTURE:**

- Gently clean with an environmentally-friendly soap solution and water using a sponge or washcloth.
- Do not use abrasive materials, wire brushes, chemicals, harsh cleaners, or bleach.
- Rinse using a garden hose and air dry.
- Do not use pressure washer.
- If there are nicks, chips, and/or scratches see the part # of the paint in the parts list to obtain a matching touch-up paint.

## **MAINTENANCE NOTES**

1. In case of a defective or damaged part, or for any other questions concerning the product, please contact the manufacturer directly.
2. Please have the parts list and part numbers on hand when ordering or requesting replacement parts.
3. The product should not be installed adjacent to trees or a sloped roof. Snow and ice may slide onto the roof and cause it to collapse.
4. While the product is designed to stay assembled year long, the roof must be kept free of accumulation of snow.



## **ONE YEAR LIMITED WARRANTY**

This product has been designed and manufactured to meet the highest standards of quality and durability. Subject to the Conditions for Exercising the Warranty and the Limitations on the Warranty set forth below, it is warranted to be free of material and manufacturing defects for a period of **one year** from the date of purchase. Missing and damage due to transportation is not covered by the manufacture warranty. Should the product become damaged, or the warranty period has expired, please contact Gazebo Penguin Customer Service Department for a complete schedule of replacement parts and prices.

## **CONDITIONS FOR EXERCISING THE WARRANTY**

The warranty only applies to the original purchaser with the bill.

In order to properly exercise your warranty, please comply with the following:

Carefully inspect the contents of the carton for missing or damaged components. Should you discover damaged or missing parts, **do not return the product to the place of purchase**, but contact Gazebo Penguin Customer Service Department at the numbers listed below:

**Montreal:** (514) 276-3485

**Elsewhere:** 1-800-737-7174

You can also find a claim form to fill out online:







<https://abrispenguin.com/assemblyinstructions/>



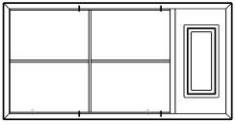

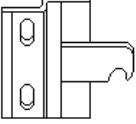
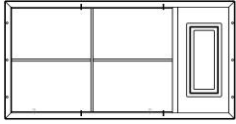
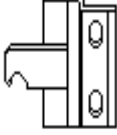
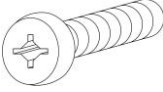
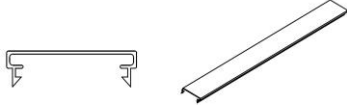
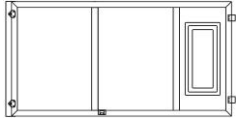
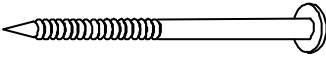
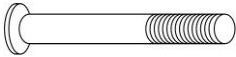

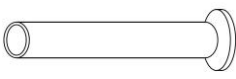

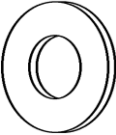
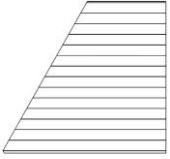
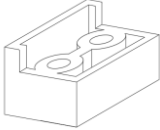

**NOTE: Damages/missing parts must be reported within 30 days of delivery. If claimed after your request might be rejected.**

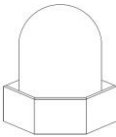
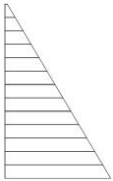

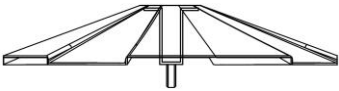

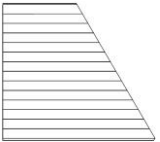

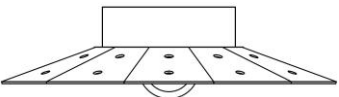
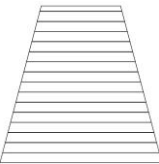
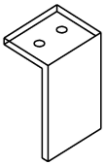

## **LIMITATIONS ON THE WARRANTY**

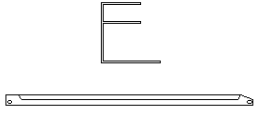
1. The product is not warranted against damages due to vandalism, abuse, falling or thrown objects, or accumulation of snow.
2. The product is not warranted against damages due to extreme weather conditions, such as thunderstorms, hail, strong wind or snow storms, or any other acts of God.
3. Leaking due to heavy rain may happen, please refer to the instruction manual for window positions and information on how to evacuate the water.
4. The product is only warranted in the event it is installed in accordance with the Gazebo Penguin's written instructions enclosed with the product.
5. The product is not warranted in the event it has been improperly anchored.
6. We reserve the right to replace or repair any defective product or parts at our discretion.
7. No change to the unit is allowed. This will void your warranty.

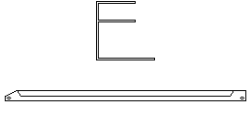

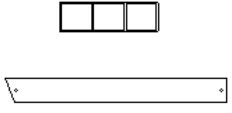

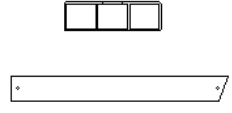
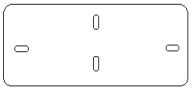
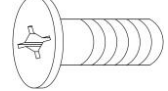

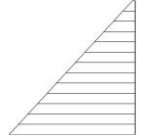
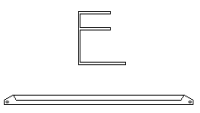
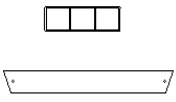
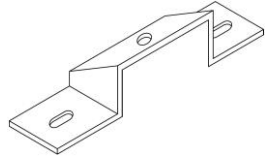
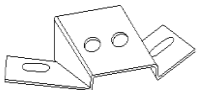
## 41212 SAND (see page 7 for Slate parts)



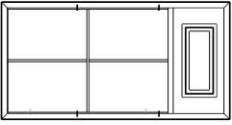

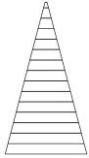
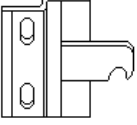
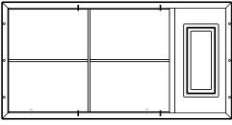
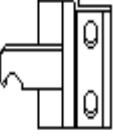
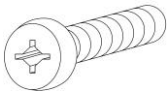
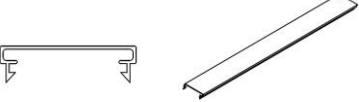
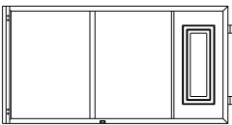
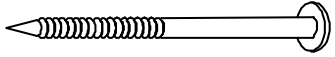
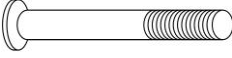



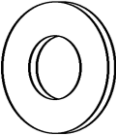
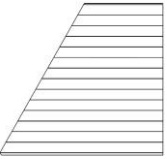
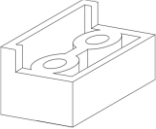

DESCRIPTION	PACKED IN BOX	QTY	DRAWING	DESCRIPTION	PACKED IN BOX	QTY	DRAWING
08-129-12 REGULAR FRAME A	3	6		08-132-12 SLIDING DOOR FRAME D	2	2	
	2	2					
17-054 ROOF PANEL Aa	6	4		08-165-12 DOOR LATCH Dd-R	1	2	
08-130-12 FRAME NEXT TO DOORS (extra holes) B	2	2		08-169-12 DOOR LATCH Dd-L	1	2	
08-158-12 SCREW M6*16 Bb	1	108		08-133-12 CONNECTING PIECE E	4	8	
08-131-12 SLIDING DOOR C	2	2		08-167-12 SCREW M6X63.5 Ee	1	20	
08-161-12 SCREW M6X70 Cc	1	12		08-136-12 DOOR RAIL F	4	2	
12-037-12 CAPNUT M5X60 Cc-2	1	12		08-137-12 DOOR RAIL G	4	2	

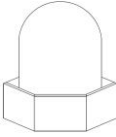
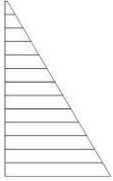
DESCRIPTION	PACKED IN BOX	QTY	DRAWING	DESCRIPTION	PACKED IN BOX	QTY	DRAWING
08-187-12 WASHER Gg	1	37		17-061 ROOF PANEL Kk	5	4	
08-138-12 DOOR STOPPER H	1	4		17-044-12 RAFTER L	4	4	
08-189-12 ACORN NUT Hh	1	1		17-057 ROOF PANEL Li	6	4	
08-139-12 CONNECTING PIECE I	4	8		08-143-12 Top Cap M	1	1	
08-193 PLASTIC PLUG li	1	20		17-058 ROOF PANEL Mm	5	4	
08-140-12 CONNECTING PIECE J	4	8		08-144-12 CENTRAL HUB N	1	1	
17-055 ROOF PANEL Jj	5	4		08-134-12 UPPER DOOR RAIL END CAP Nn	1	4	
17-043-12 RAFTER K	4	8		17-049-12 COVER FOR RAFTERS O	4	8	

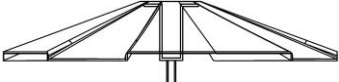

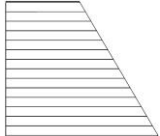

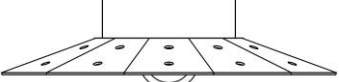
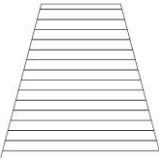
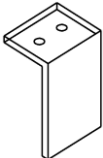

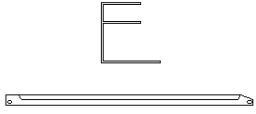

DESCRIPTION	PACKED IN BOX	QTY	DRAWING	DESCRIPTION	PACKED IN BOX	QTY	DRAWING
17-050-12 COVER FOR RAFTERS O1	4	4		17-045-12 FINISHING BAR U	1	4	
08-135-12 SCREW Oo	1	4		17-071-12 FINISHING BAR U1	1	4	
16-118-12 SCREW M6X36 Oo1	1	50		17-047-12 SOLIDIFYING BAR V	1	4	
17-051-12 GAP COVER BAR P	1	12		17-070-12 SOLIDIFYING BAR V1	1	4	
18-067-12 SOLIDIFYING BAR BRACKET Pp	1	12		12-047-12 SCREW M5X15 Ww	1	12	
17-053-12 END CAP R	1	12		17-060 ROOF PANEL Y	6	4	
17-046-12 FINISHING BAR S	1	4					
17-048-12 SOLIDIFYING BAR T	1	4		15-125-12 STEEL ANGLE Z2 (assembled to rafter)	1	4	
15-124-12 STEEL ANGLE Z1 (assembled to rafter)	1	8		<b>*NOT INCLUDED IN THE BOX</b>			
				DESCRIPTION	COLOUR	PART #	
				SPRAY PAINT	SAND	11-699	
PAINT PEN	18-245						

## 41212MR SLATE

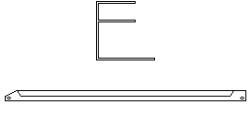
DESCRIPTION	PACKED IN BOX	QTY	DRAWING	DESCRIPTION	PACKED IN BOX	QTY	DRAWING
08-129-32 REGULAR FRAME A	3	6		08-132-32 SLIDING DOOR FRAME D	2	2	
	2	2					
17-054 ROOF PANEL Aa	6	4		08-165-32 DOOR LATCH Dd-R	1	2	
08-130-32 FRAME NEXT TO DOORS (extra holes) B	2	2		08-169-32 DOOR LATCH Dd-L	1	2	
08-158-32 SCREW M6*16 Bb	1	108		08-133-32 CONNECTING PIECE E	4	8	
08-131-32 SLIDING DOOR C	2	2		08-167-32 SCREW M6X63.5 Ee	1	20	
08-161-32 SCREW M6X70 Cc	1	12		08-136-32 DOOR RAIL F	4	2	
12-037-32 CAPNUT M5X60 Cc-2	1	12		08-137-32 DOOR RAIL G	4	2	

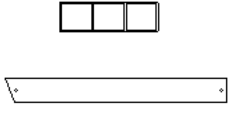
DESCRIPTION	PACKED IN BOX	QTY	DRAWING	DESCRIPTION	PACKED IN BOX	QTY	DRAWING
08-187 WASHER Gg	1	37		17-061 ROOF PANEL Kk	5	4	
08-138-32 DOOR STOPPER H	1	4		17-044-32 RAFTER L	4	4	
08-189-32 ACORN NUT Hh	1	1		17-057 ROOF PANEL LI	6	4	
08-139-32 CONNECTING PIECE I	4	8		08-143-32 Top Cap M	1	1	
08-193 PLASTIC PLUG li	1	20		17-058 ROOF PANEL Mm	5	4	
08-140-32 CONNECTING PIECE J	4	8		08-144-32 CENTRAL HUB N	1	1	
17-055 ROOF PANEL Jj	5	4		08-134-32 UPPER DOOR RAIL END CAP Nn	1	4	
17-043-32 RAFTER K	4	8		17-049-32 COVER FOR RAFTER O	4	8	

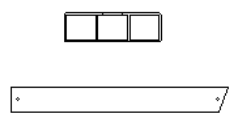
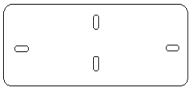
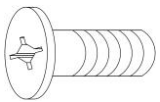

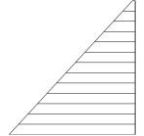
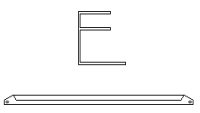
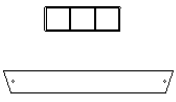
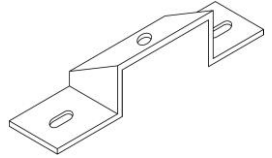
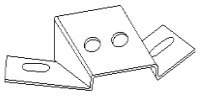
DESCRIPTION	PACKED IN BOX	QTY	DRAWING	DESCRIPTION	PACKED IN BOX	QTY	DRAWING
17-050-32 COVER FOR RAFTER O1	4	4		17-045-32 FINISHING BAR U	1	4	
08-135-32 SCREW Oo	1	4		17-069-32 FINISHING BAR U1	1	4	
16-118-32 SCREW M6X36 Oo1	1	50		17-047-32 SOLIDIFYING BAR V	1	4	
17-051-32 GAP COVER BAR P	1	12		17-070-32 SOLIDIFYING BAR V1	1	4	
18-067-32 SOLIDIFYING BAR BRACKET Pp	1	12		12-047-32 SCREW M5X15 Ww	1	12	
17-053-32 END CAP R	1	12		17-060 ROOF PANEL Y	6	4	
17-046-32 FINISHING BAR S	1	4					
17-048-32 SOLIDIFYING BAR T	1	4		15-125-32 STEEL ANGLE Z2 (assembled to rafter L)	1	4	
15-124-32 STEEL ANGLE Z1 (assembled) to rafter K)	1	8		<b>*NOT INCLUDED IN THE BOX</b>			
				DESCRIPTION	COLOUR	PART #	
				SPRAY PAINT	SLATE	18-125	
PAINT PEN	18-126						

## Before you assemble the Solarium

**PLEASE DON'T DESTROY THE BOXES UNTIL COMPLETELY ASSEMBLED**

### Tools needed:

- Step Ladder 6'-8'
- #2 Phillips, #2 Robertson Screwdriver (not supplied)
- Rubber Mallet
- Various Files
- 12" piece of wood

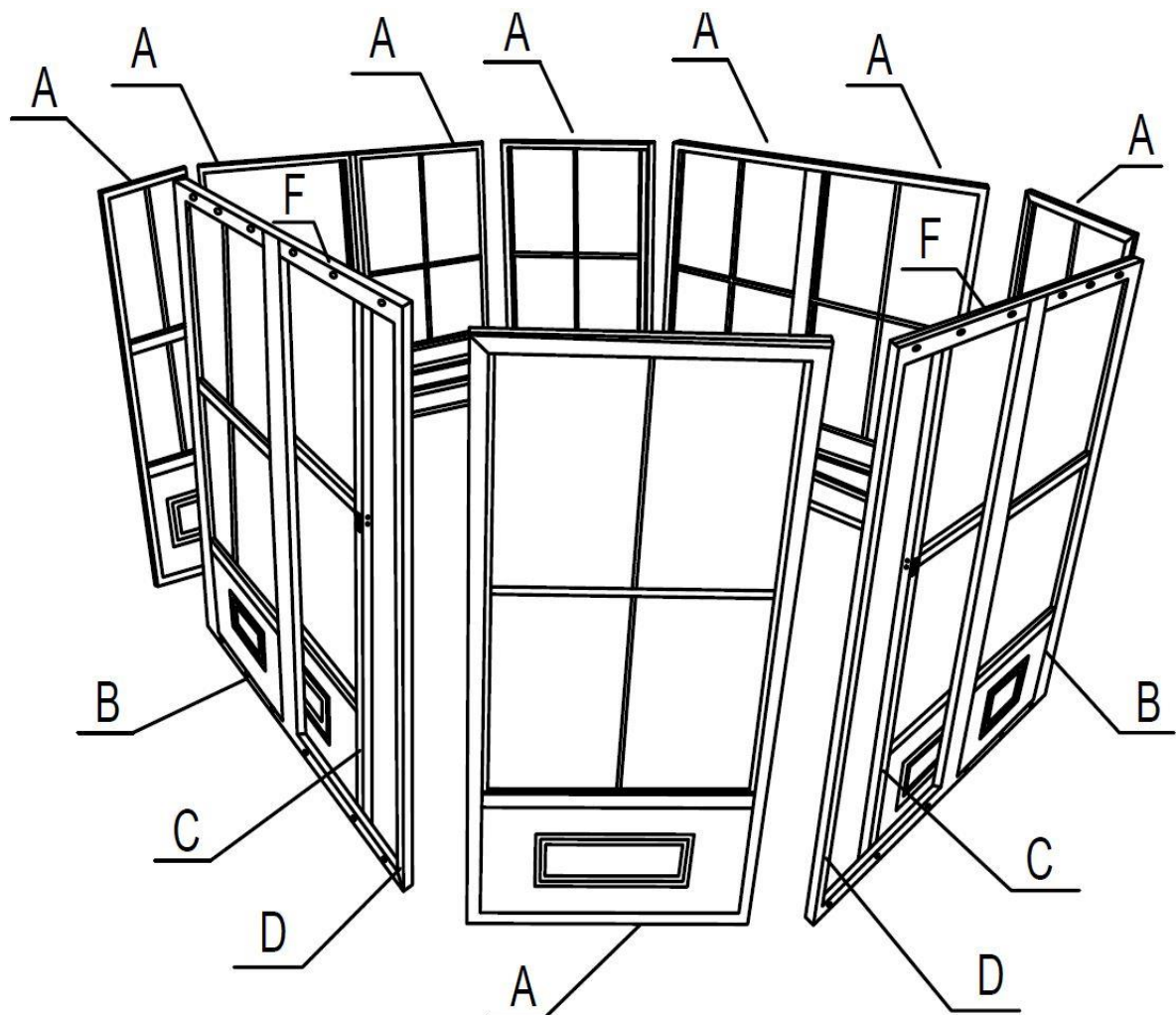

Based on the location, decide where you would like to position the two (2) doors panels which can slide open to the left or the right, your choice.

# Assembly Instructions

## 12x12 Solarium

Pre-assembled steel angle (Z1, Z2) to roof Rafters (K, L) respectively, using Bolts (Bb).

### To Be Assembled Before Packing

4 Steel Angles (Z1) to be attached to the right hole and remaining 4 to the left hole.

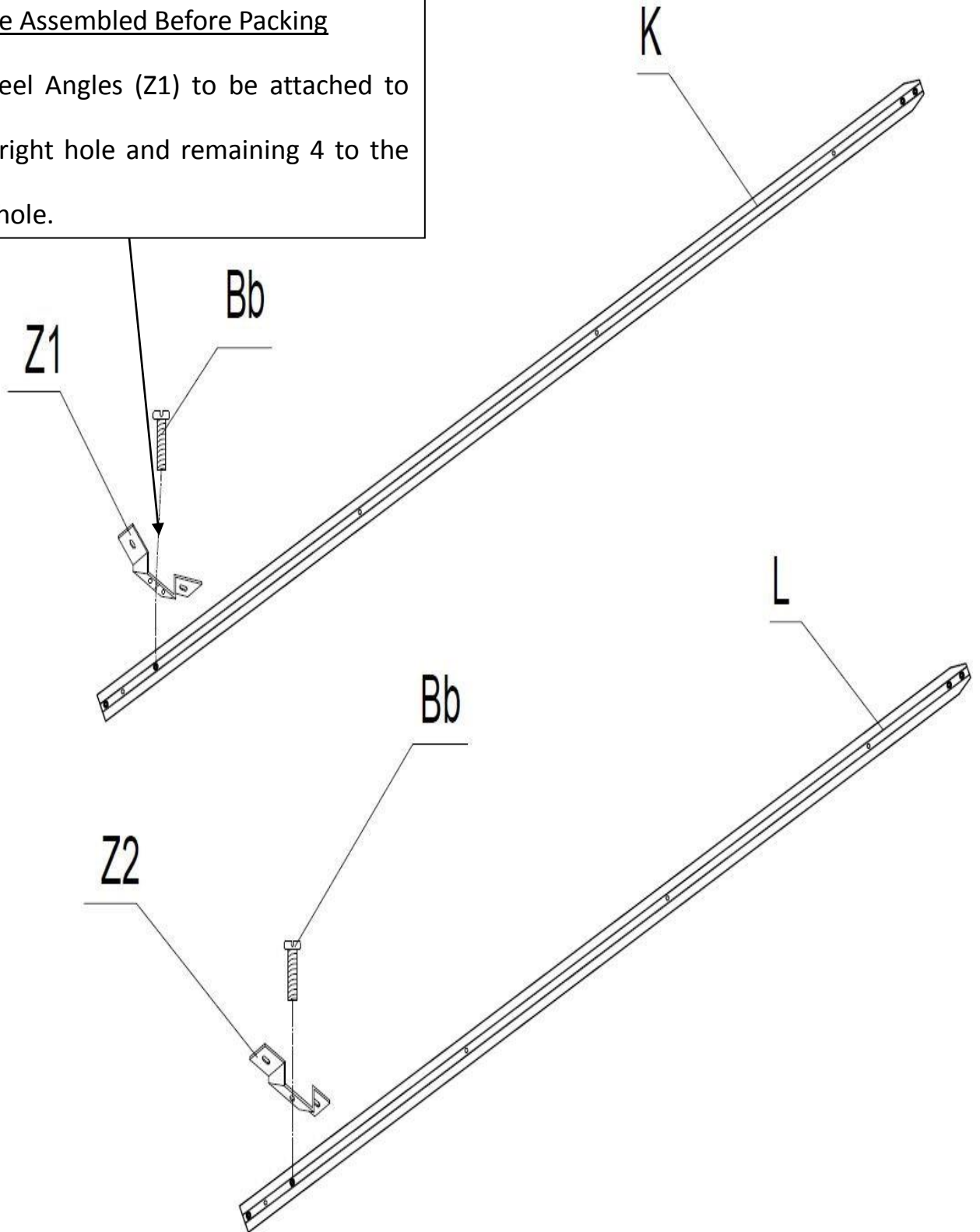

### Step 1:

1. Stand up two Frames (A), using two Connecting Pieces (I, J) slide from top to bottom and affix the panels together.
2. Stand up a frame meant to be next to the Door (B) and a Door Frame (D), placing the door frame either on the left or right, then use two Connecting Pieces (E) slide from top to bottom to affix the Panel B and Door Frame D.
3. When assembling Angled Panels (A), you should put the two panels at 135 degree angle then use the angled Connecting Pieces (I) and (J) slide from top to bottom to affix the panels together.
4. Frame screening should be facing the outside of the unit.
5. Door frame step down is on the inside of the unit.
6. When sliding the part I, J and E into the frames shake the frames for it too slide. Do not apply excess force. Make sure the edges are clean from any extra paint if necessary use a fine file.

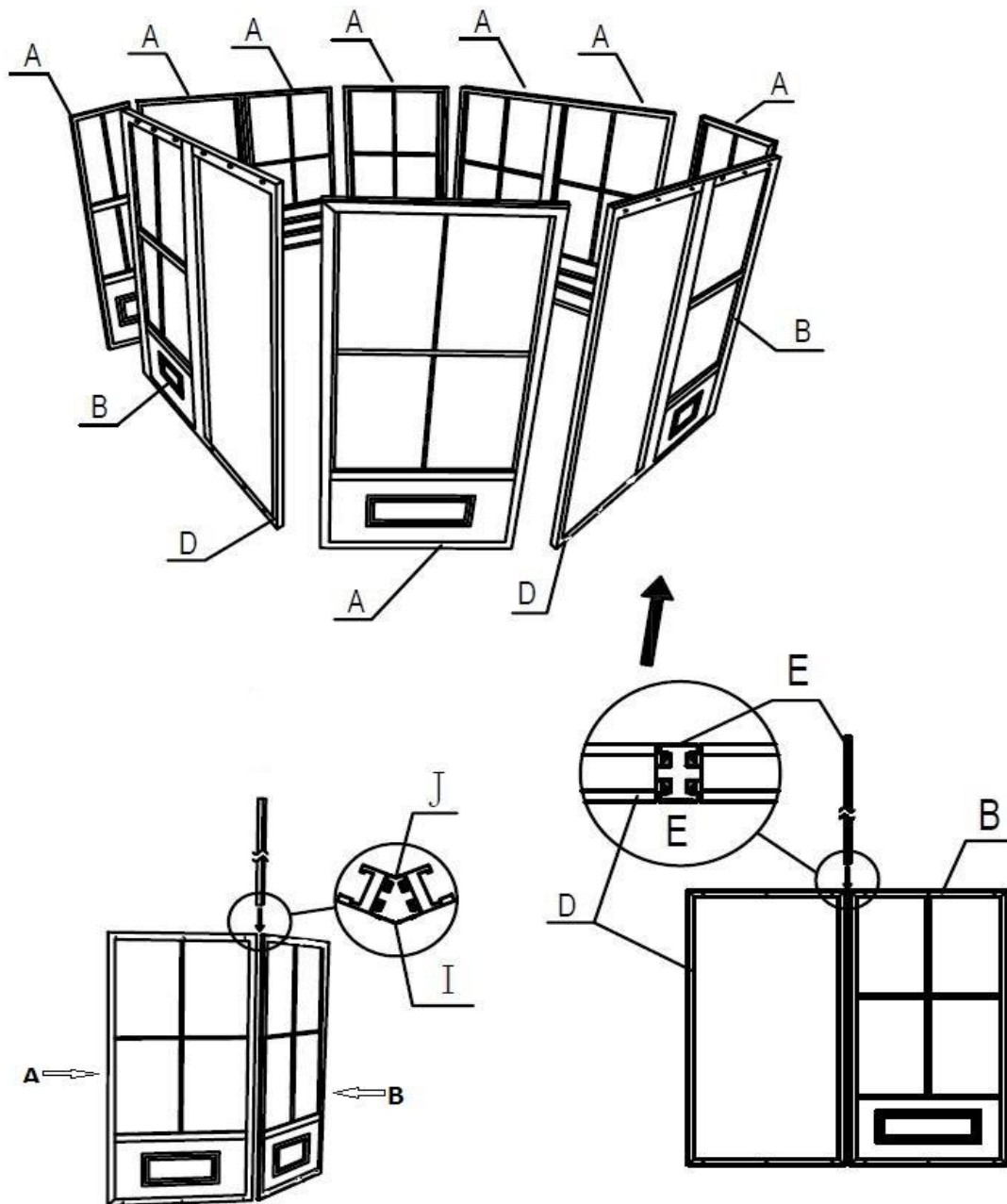

**Step 2:**

1. Affix Gap Cover Bars (P) by sliding them on top of the exterior groove of the Frames (A, B, D)

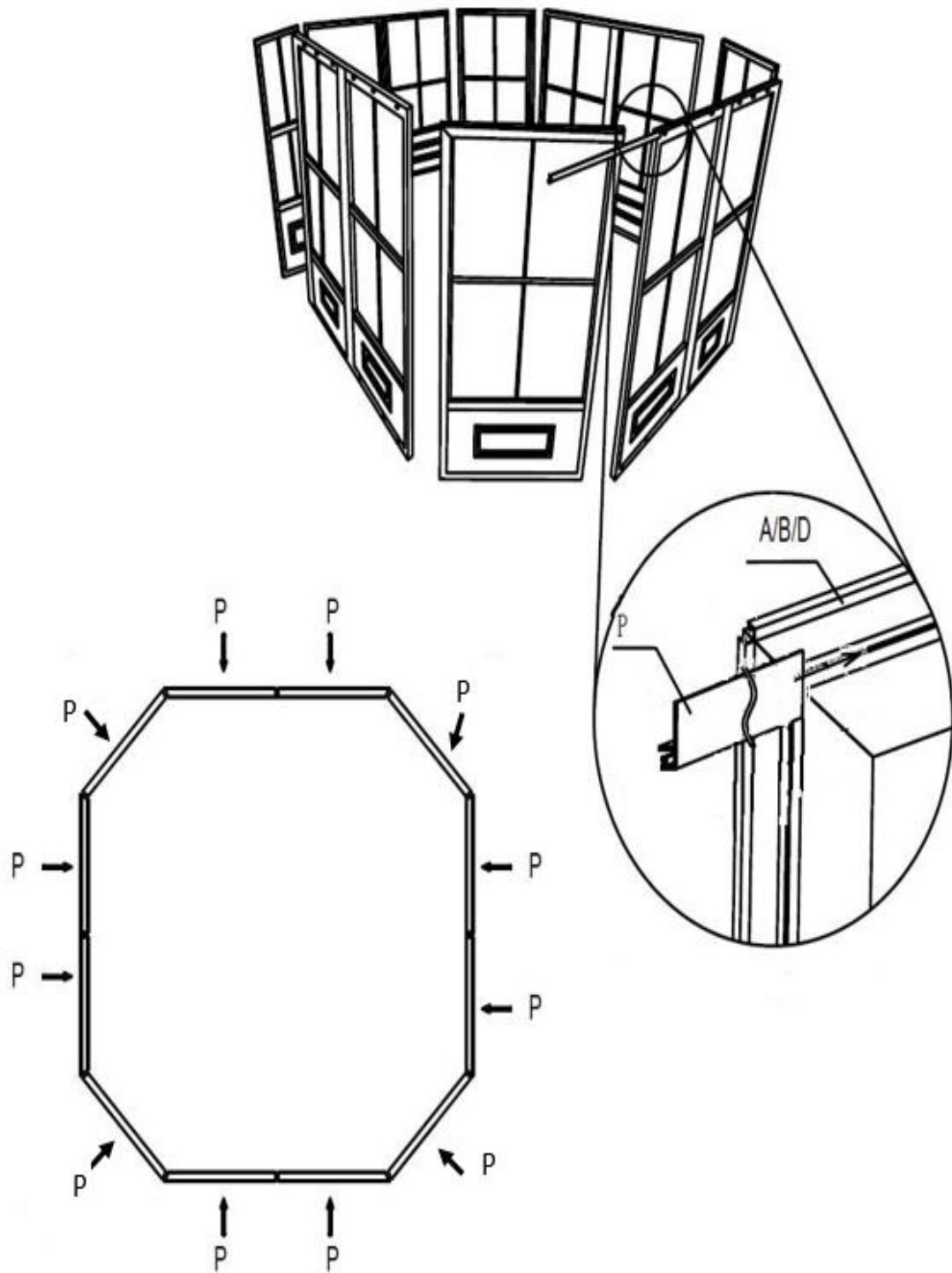

**Step 3:**

1. Slide Top Door Rail (F) into wheels of Sliding Door (C).
2. Slide Lower Door Rail (G) into the plastic guide of the Sliding Door (C).
3. Use Bolts (Bb) to affix the plastic Stoppers (H) one on each end of Top Door Rail (F).
4. Using a Screw (Oo) affix the upper door rail End Caps (Nn) one on each end of Top Door Rail (F).

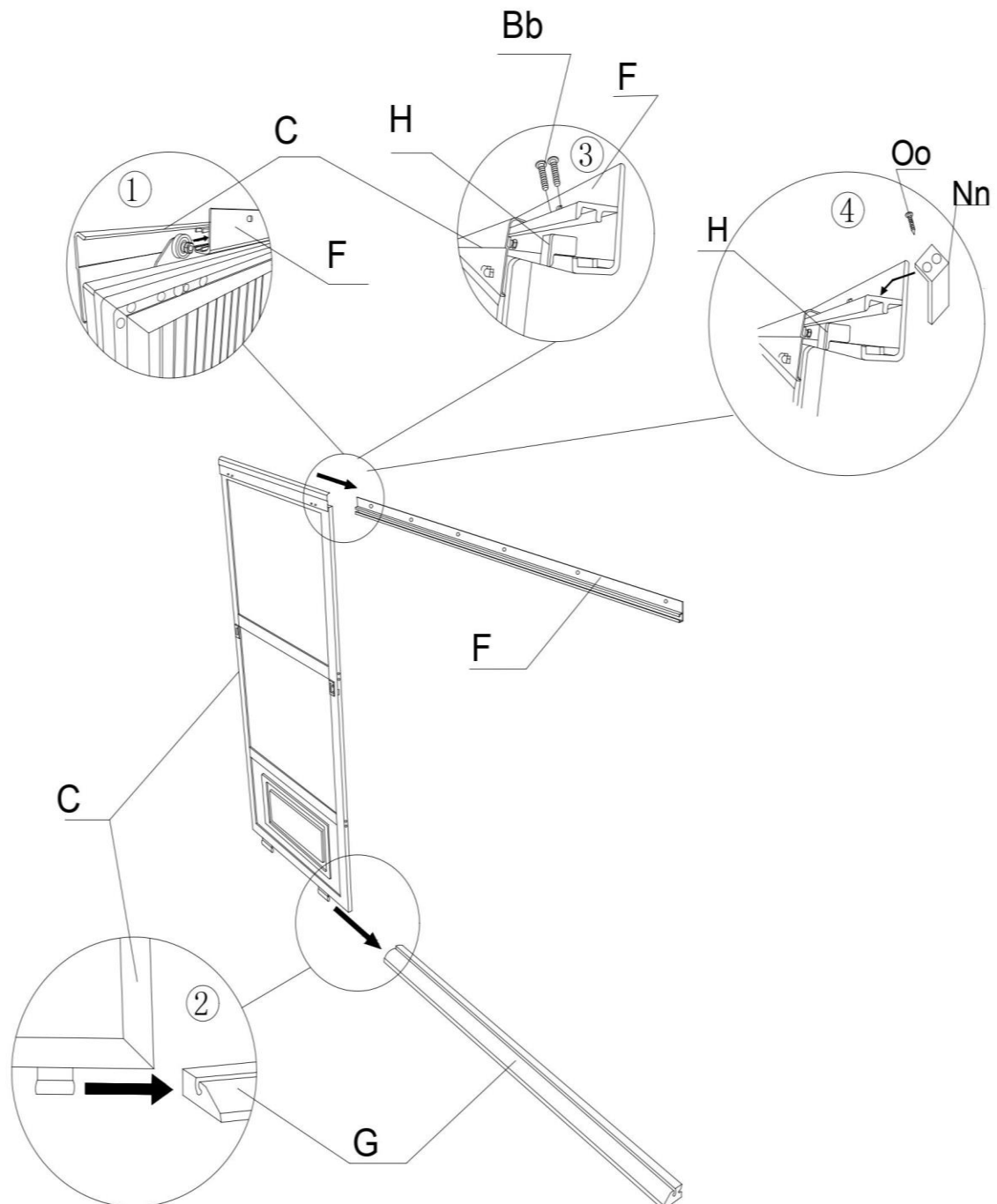

#### Step 4:

Please note the sliding door is suggested to be installed from the inside of the solarium

1. Place a Bolt (Ww) and Washer (Gg) through the Top Door Frame (D) and Door Top Rail (F), and place a Female Bolt (Cc-2) from the other side. Once all are inserted, tighten them all securely.
2. Secure the Bottom Door Rail (G), using a Bolt (Cc) with a Washer (Gg).
3. Use Bolt (Bb) to affix the Door Latch (Dd-R, Dd-L) onto the frame.

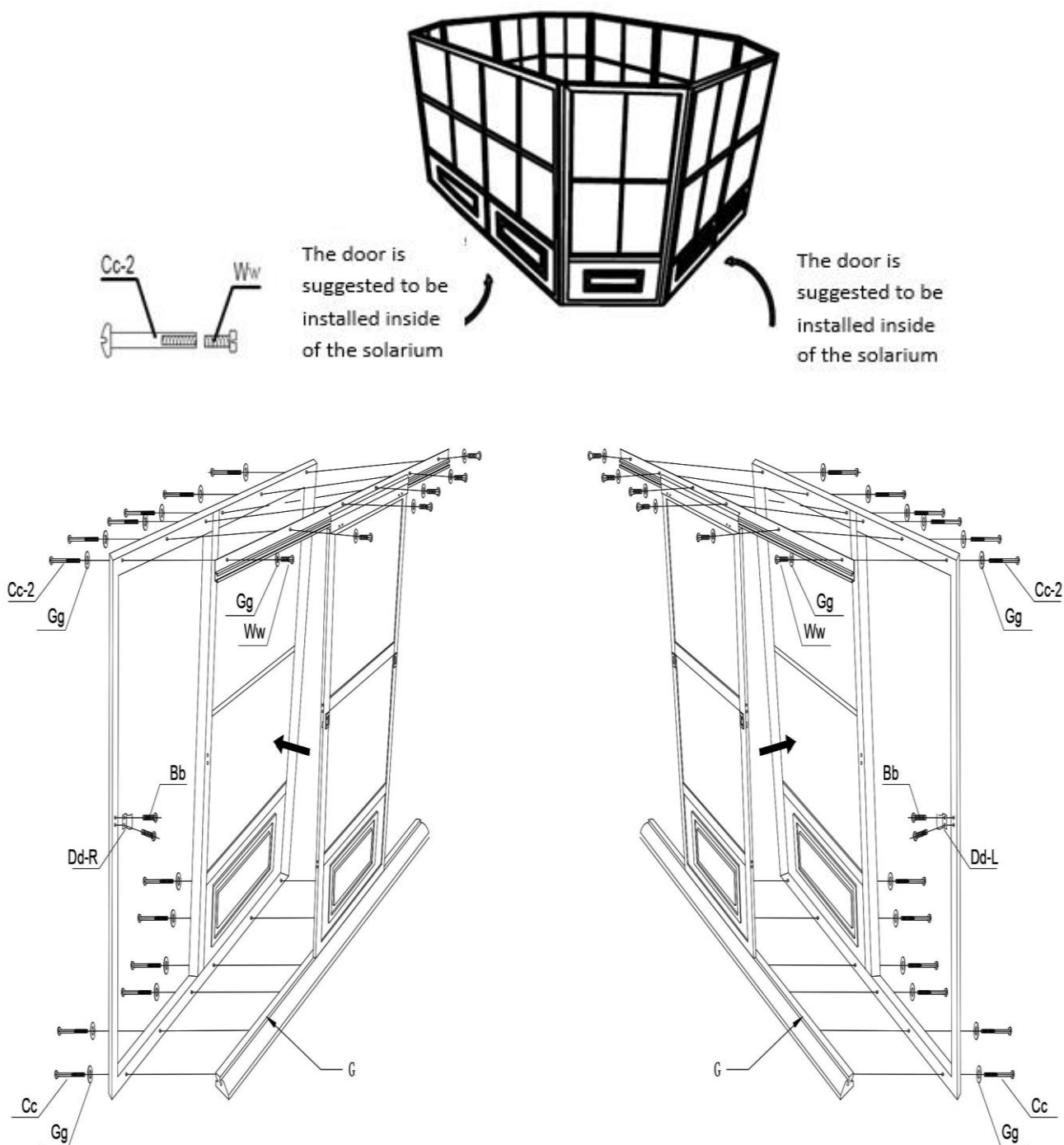

### Step 5:

1. Attach roof Rafters (K) to the Central Hub (N) using Bolts (Bb).
2. Use Screws (Z) to affix the Rafters (K) onto the top of panels going through the Metal Piece (Z1) attached to the Rafter (K).

#### Note:

1. Rafters must be affixed where panels connect to each other.
2. Affix the Rafter (K) such that, the extra hole on the bracket (Z1) are facing each other as shown below.

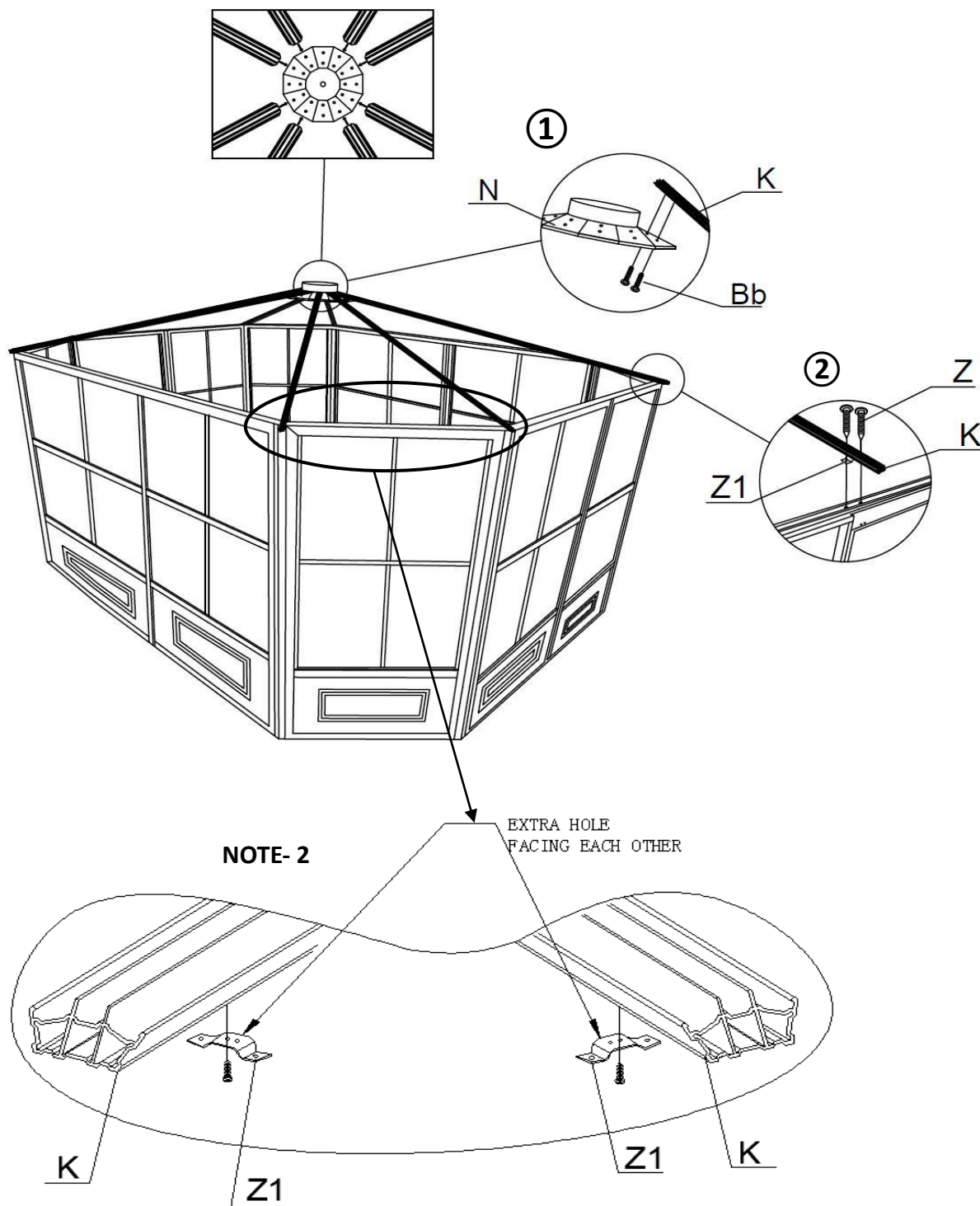



**Step 6:**

1. Follow the same procedure of Rafter (K) to assemble roof Rafters (L) onto the remaining panels.

**Note: Do not tighten the bolts right away as you may have to adjust the angle when inserting the roof panels.**

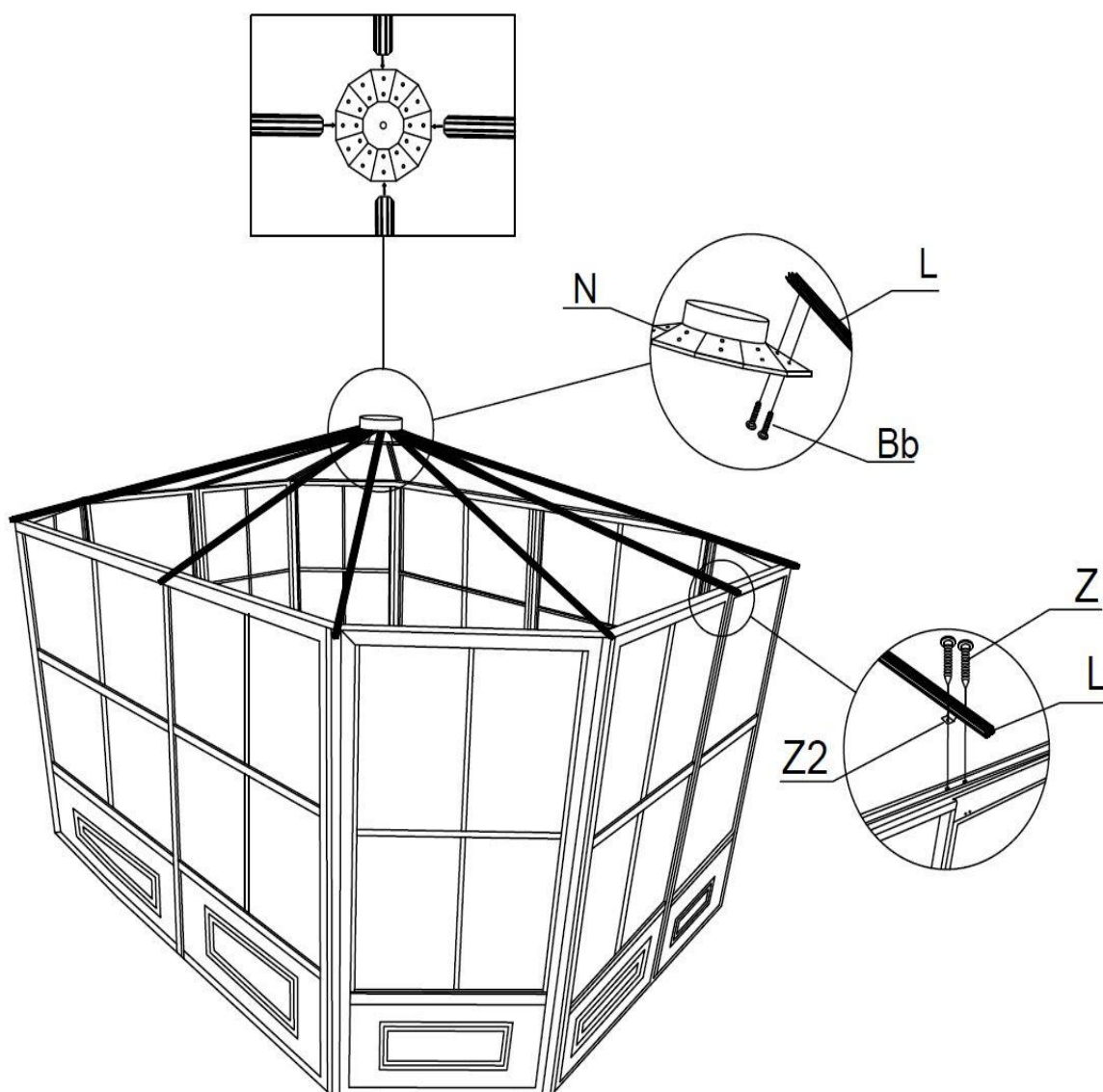

### Step 7:

1. Now secure the sides of the roof with Finishing Bar (S, U, and U1) with Bolts (Bb) and Brackets R.
2. Place roof Finishing Bars (S, U, and U1) on the right of the Roof Finishing Bar (S, U, and U1) and align the holes in each bar one on top of the other. Place End Caps (R) under the aligned holes and secure with Bolts (Bb).
3. Repeat the process with the remaining finishing bars as illustrated.
4. In order to finish the installation of the last Finishing Bar (S, U, and U1) you have to unscrew the first Bolts (Bb) at your starting point and place an End Cap (R) then re-install the Bolts (Bb).

**NOTE : Make sure all screws/ bolts are tight, when finished assembling.**

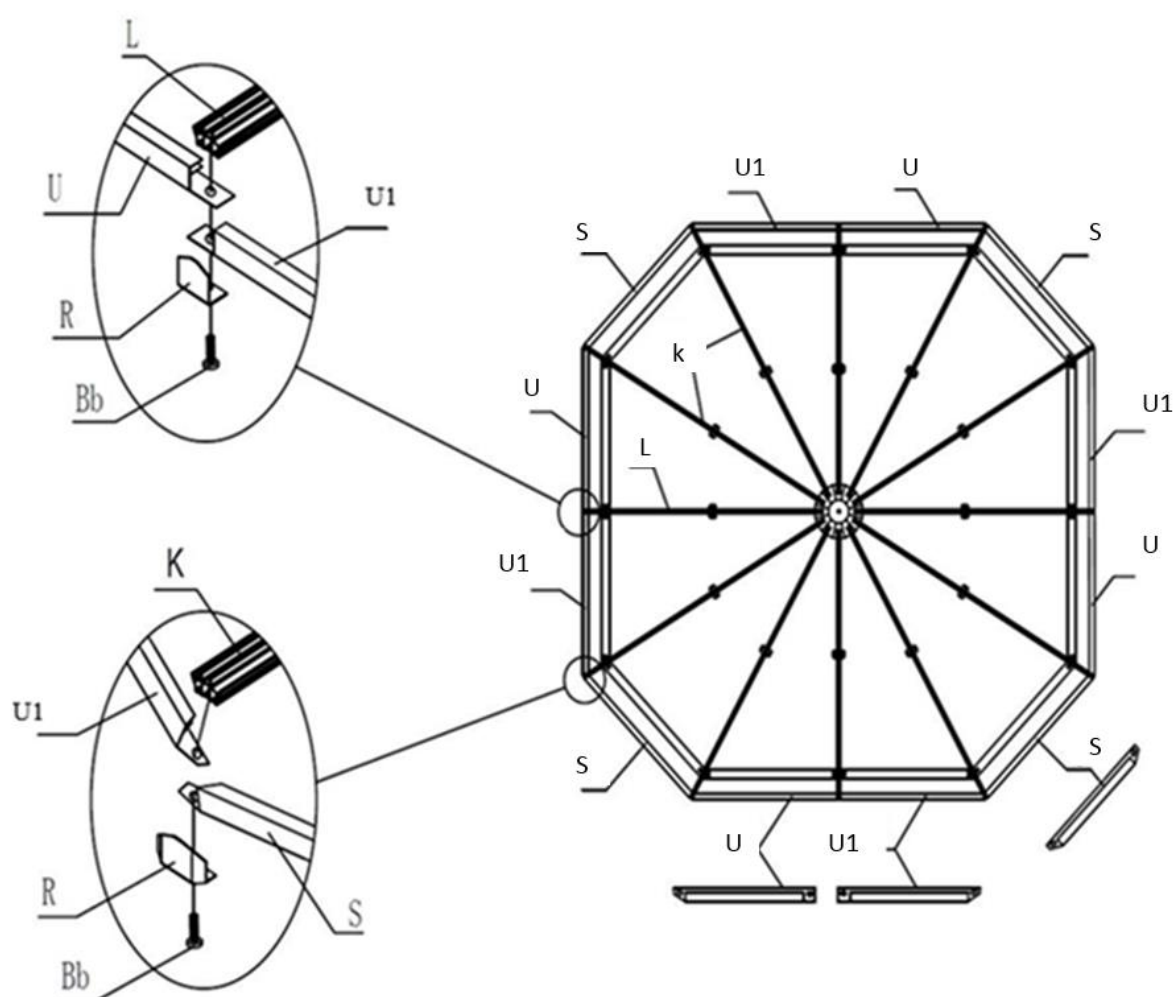

**Step 8:**

1. From the inside of the solarium, install all the Brackets (Pp) using Bolts (Bb) on the Rafters L & K.
2. From the inside of the solarium, install the Solidifying Bar (T, V, and V1) as illustrated using the Bolts (Bb).

**NOTE : Make sure all screws/ bolts are tight.**

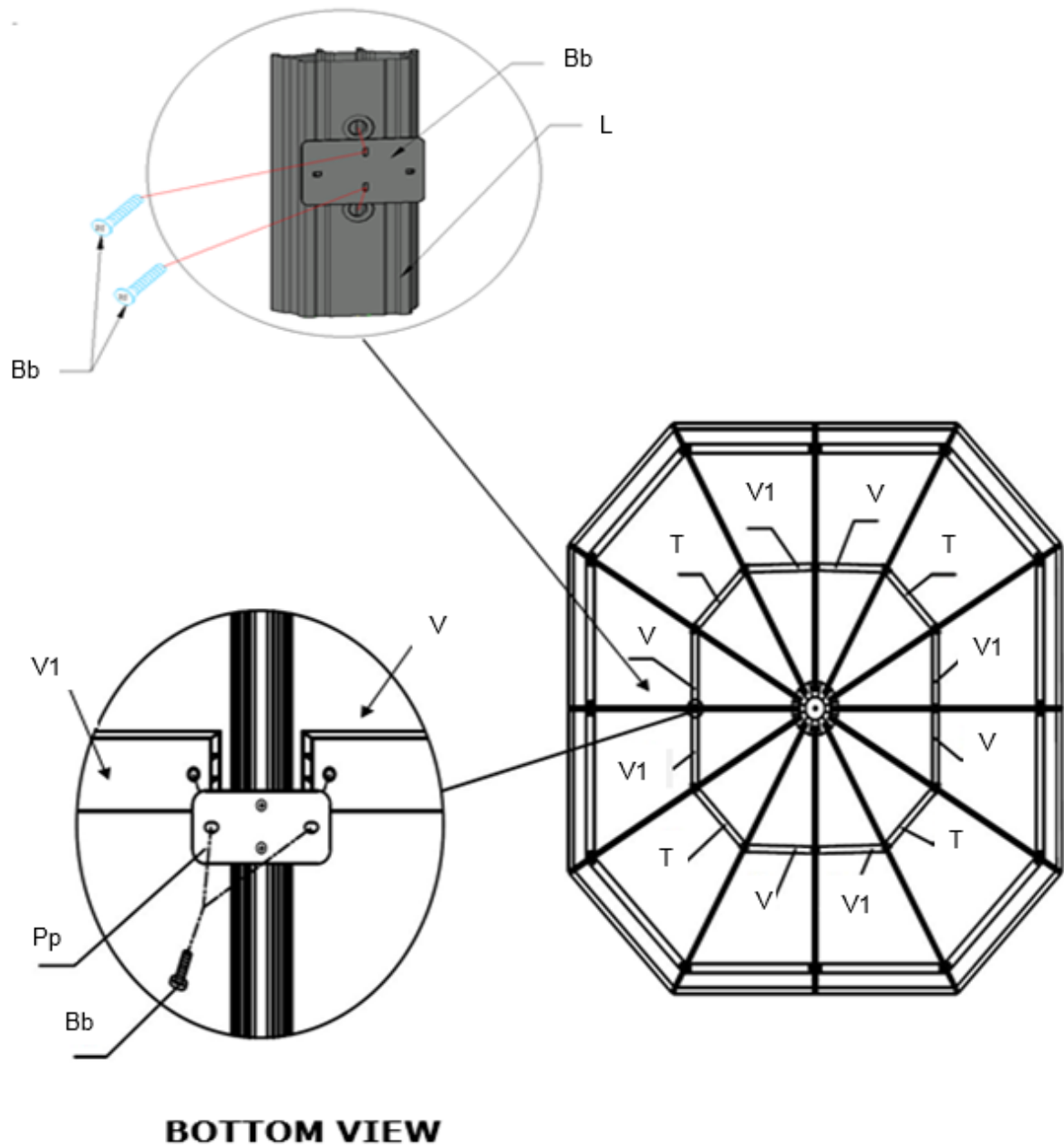

**Step 9:**

1. Install the bottom Roof Panels (Jj, Kk, and Mm) by sliding them onto Finishing Bar (S, U, U1).

**NOTE:**

1. Please refer to the stickers on how to place the roof panels.
2. Make sure all screws/ bolts are tight.

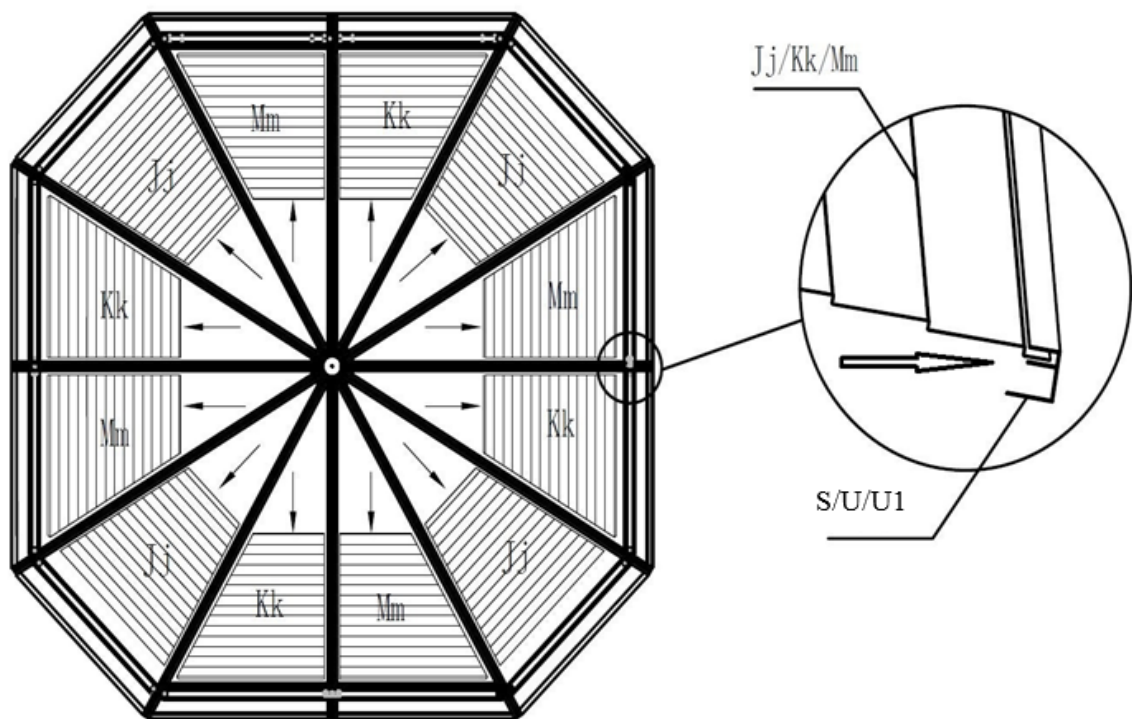

**TOP VIEW**

**Step 10:**

1. Install the upper Roof Panel (Aa) by sliding them on top of roof Rafters (K).

**NOTE:** Please refer to the stickers on how to place the roof panels.

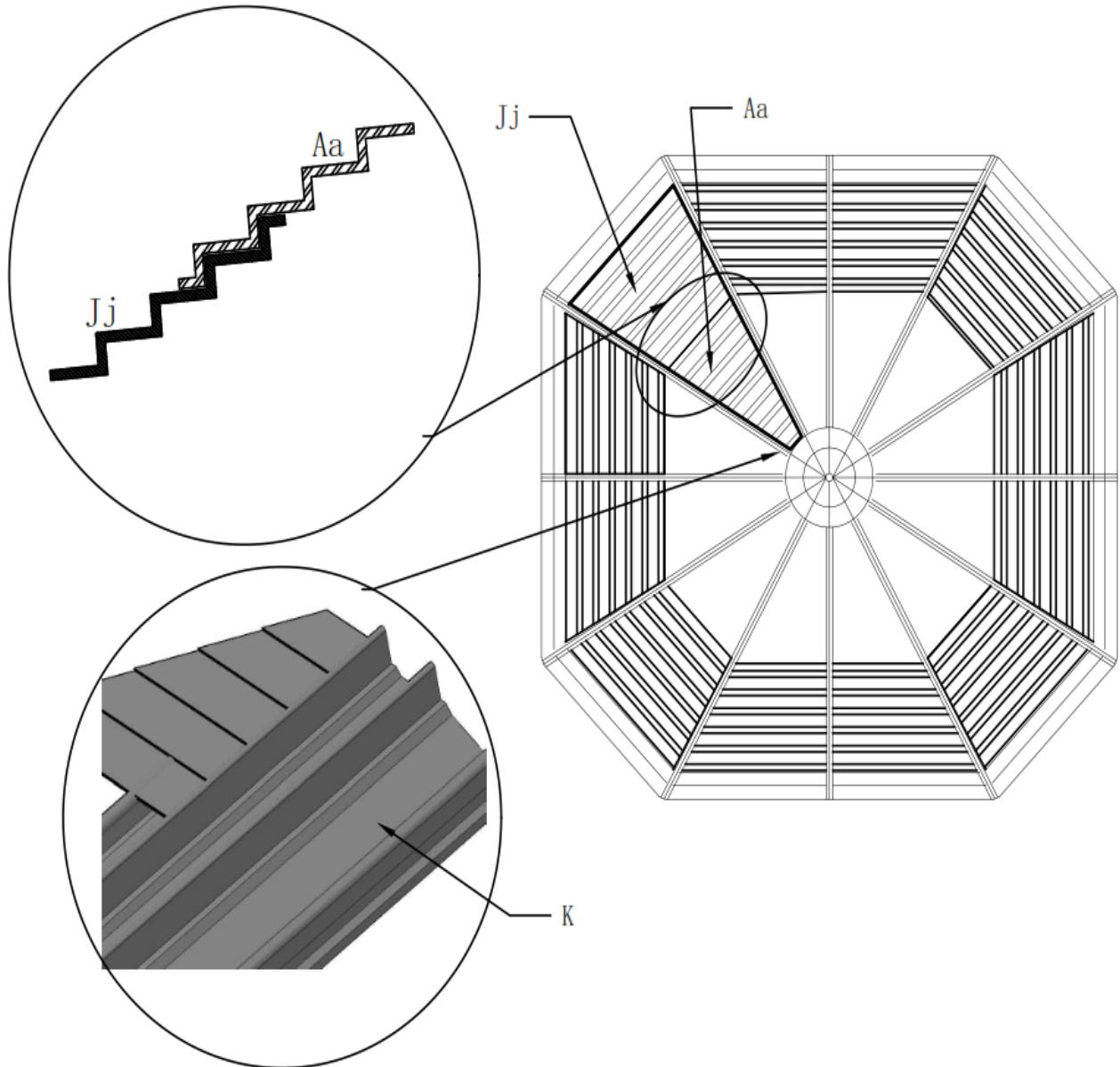

**Step 11:**

1. Once installation of the Roof Panel (Aa) is complete, affix it using the Cover for Rafters(0) using the Screws (Oo1) on one side only, then place another roof panel and repeat step until last roof panel is installed using all Cover for Rafters (0 & 01).

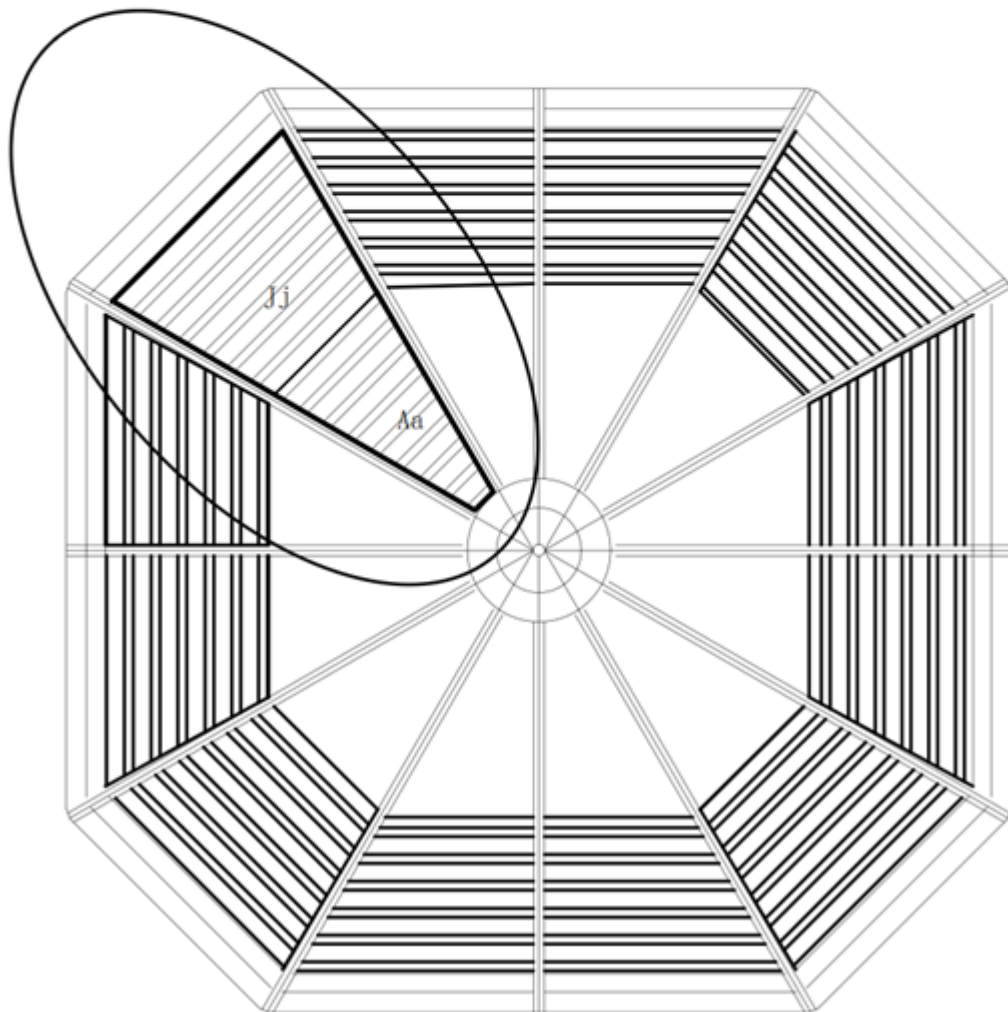
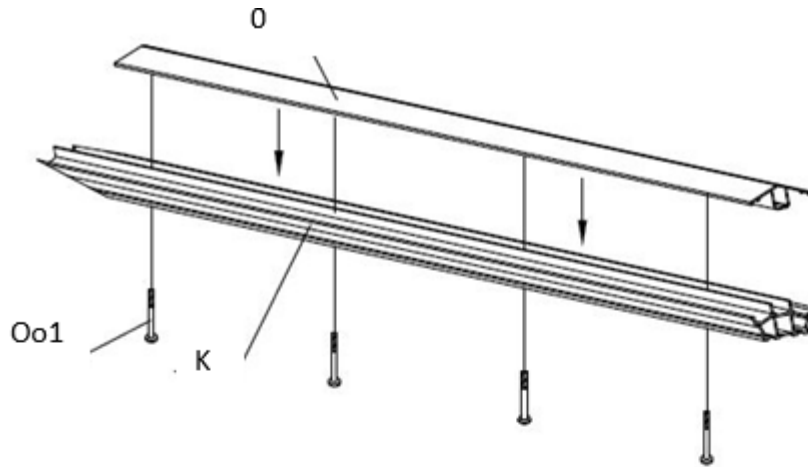

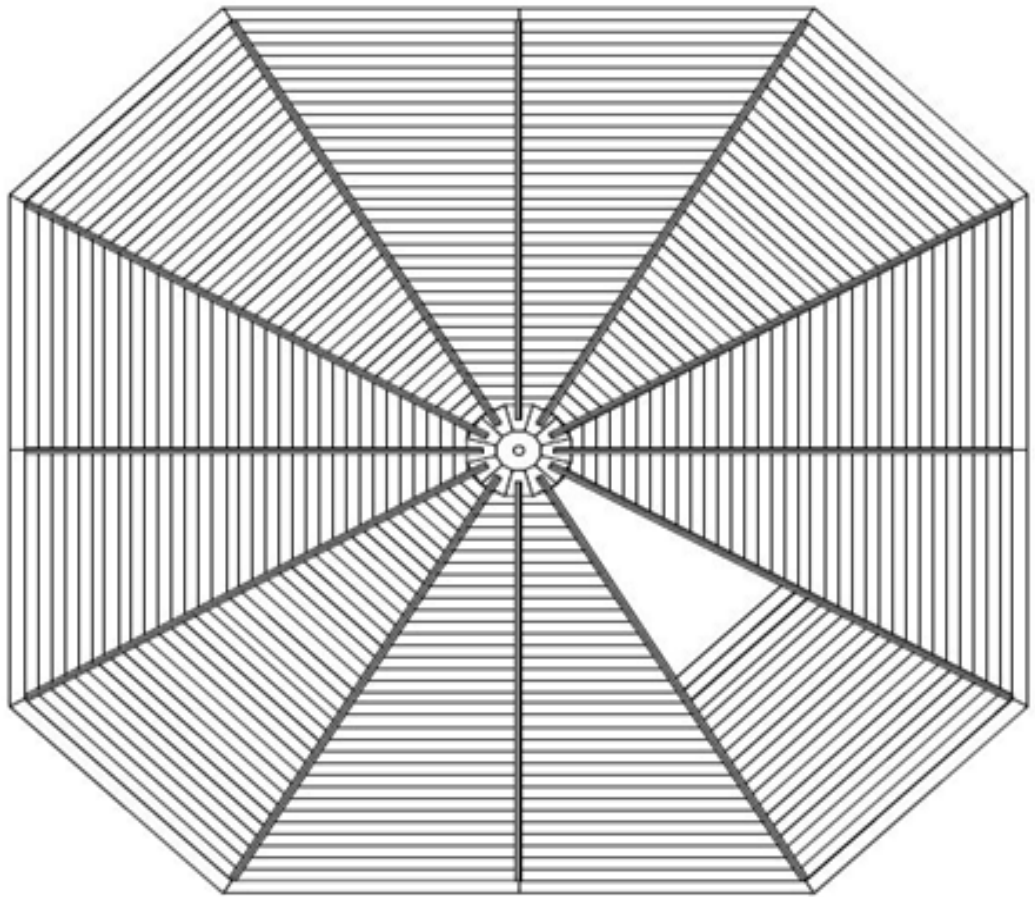
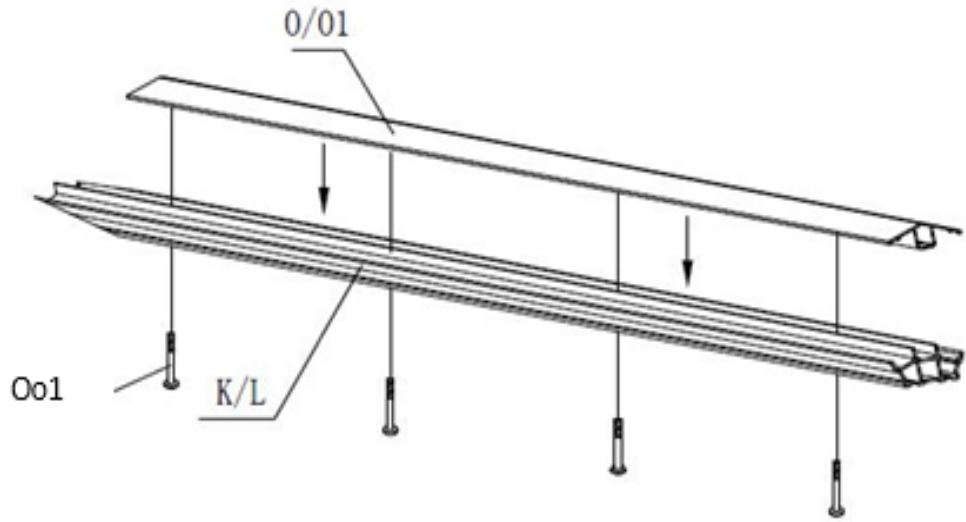

**Step 12:**

1. Put Top Cap (M) on top of the Central Hub (N).

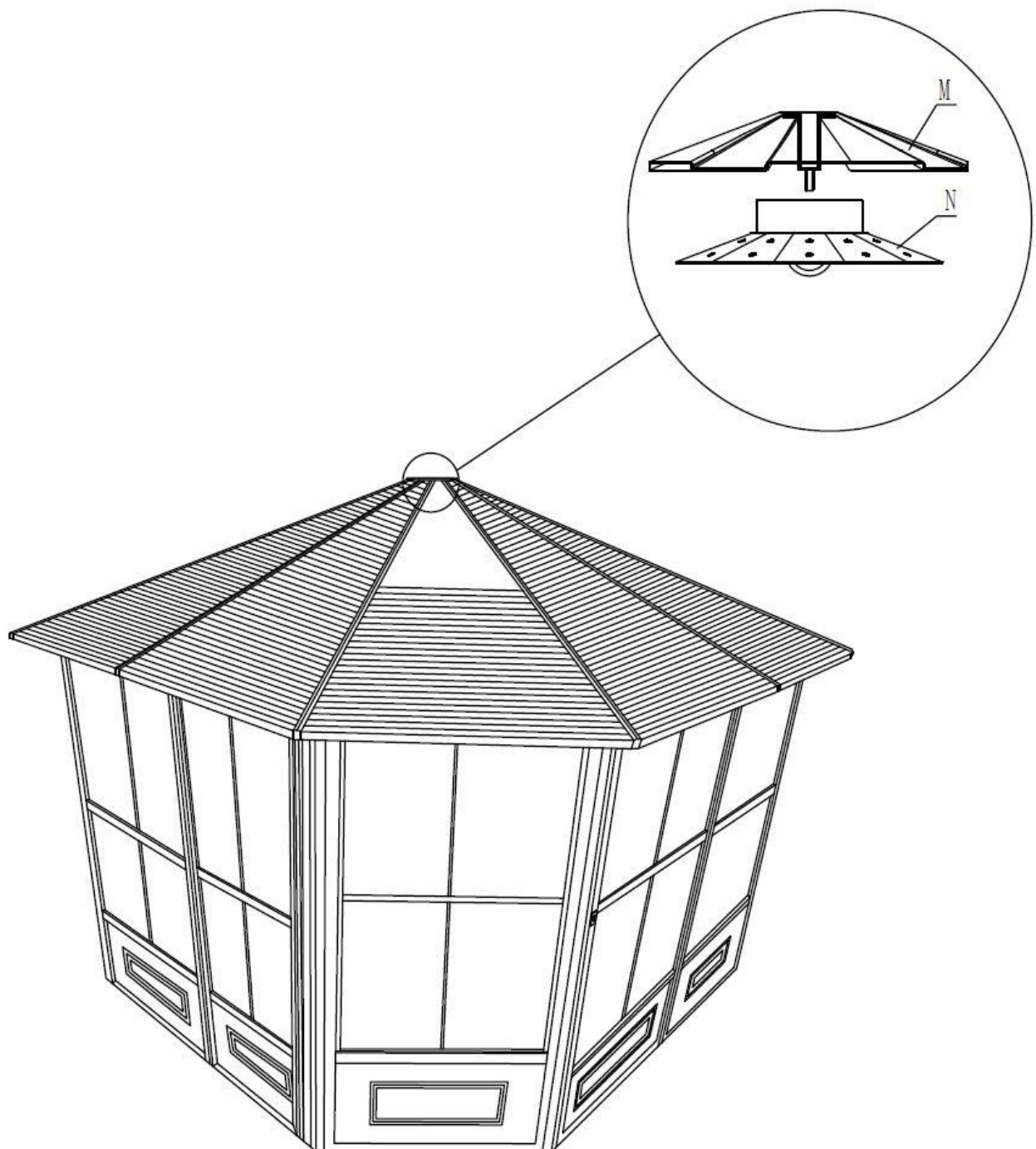



**Step 13:**

1. Install the last Roof Panel (Aa).

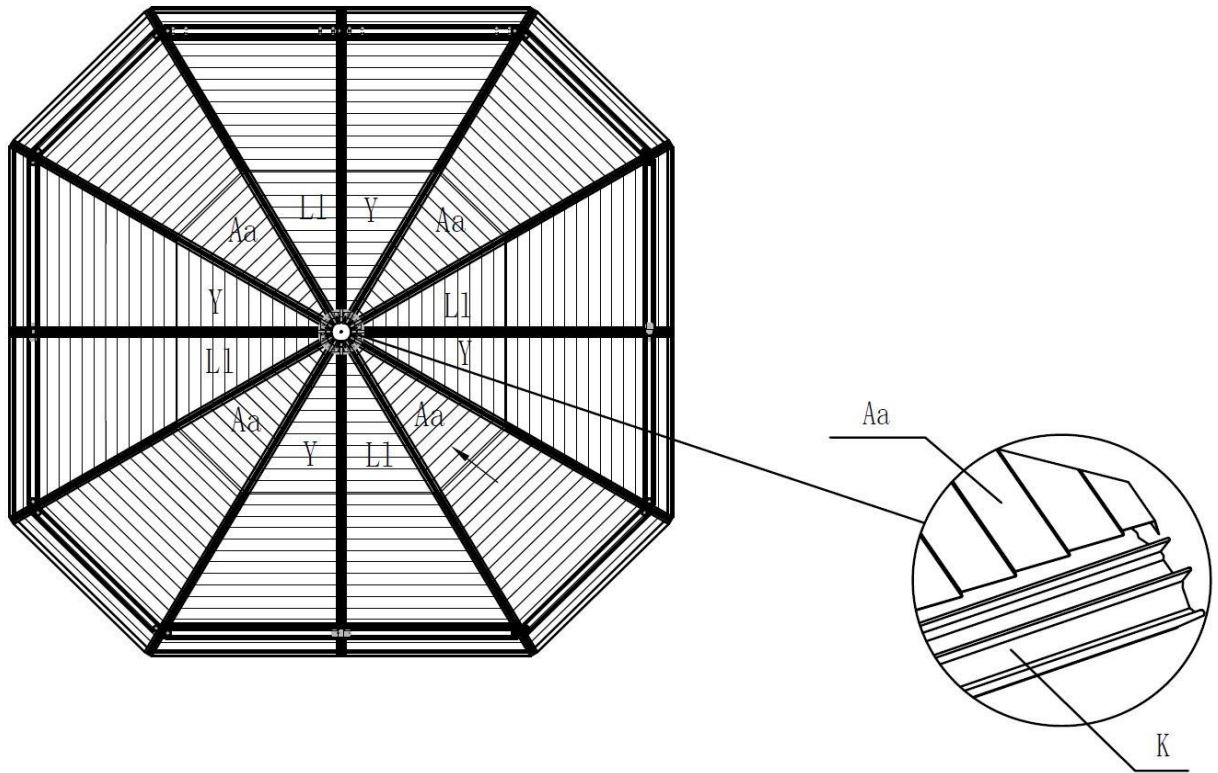

**TOP VIEW**

**Step 14:**

1. Once the last roof panel is installed, screw last Cover for Rafters (O) to the Rafter (K) with bolts (Oo1).

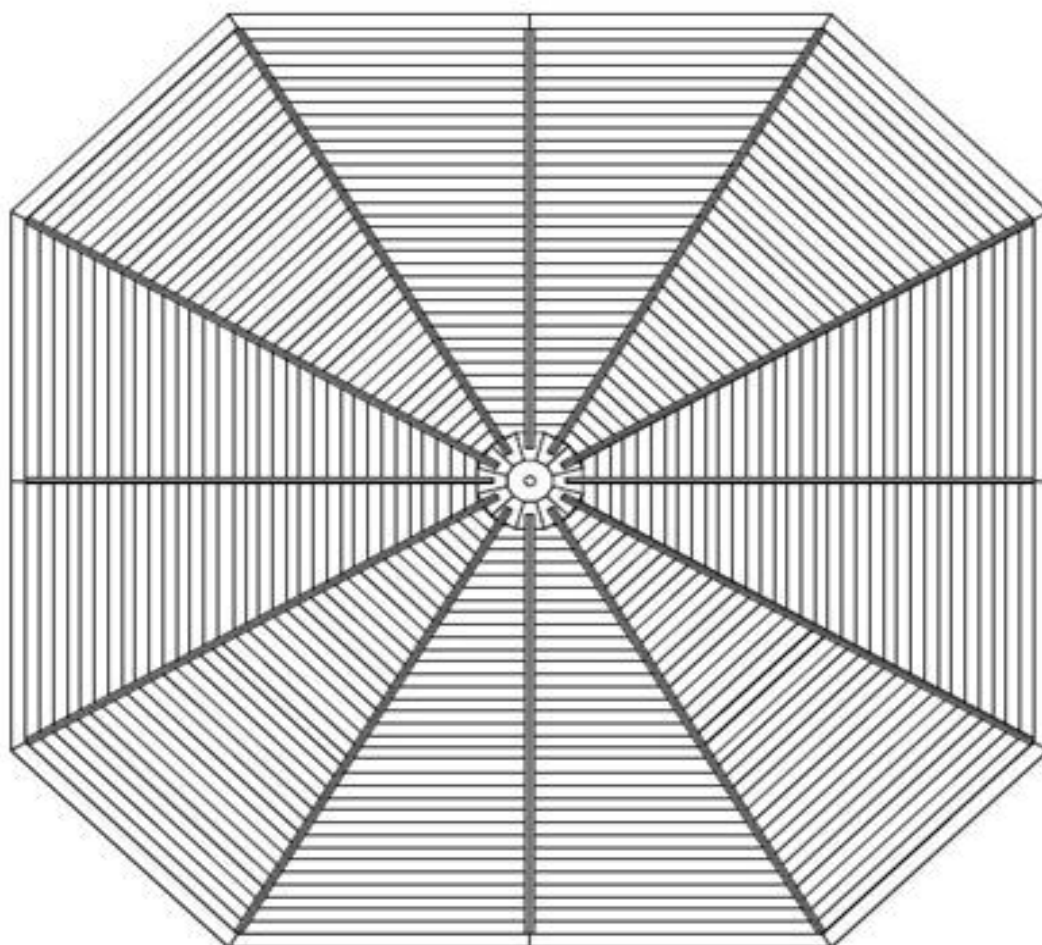
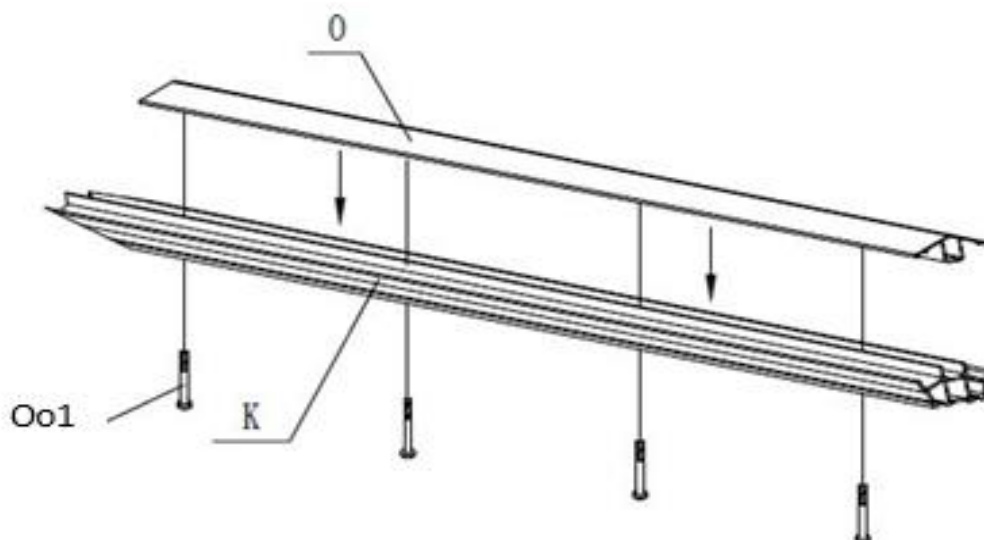

**Step 15:**

1. Use Acorn Nut (Hh) and Washer (Gg) to affix the Top Cap (M) to the Central Hub (N).

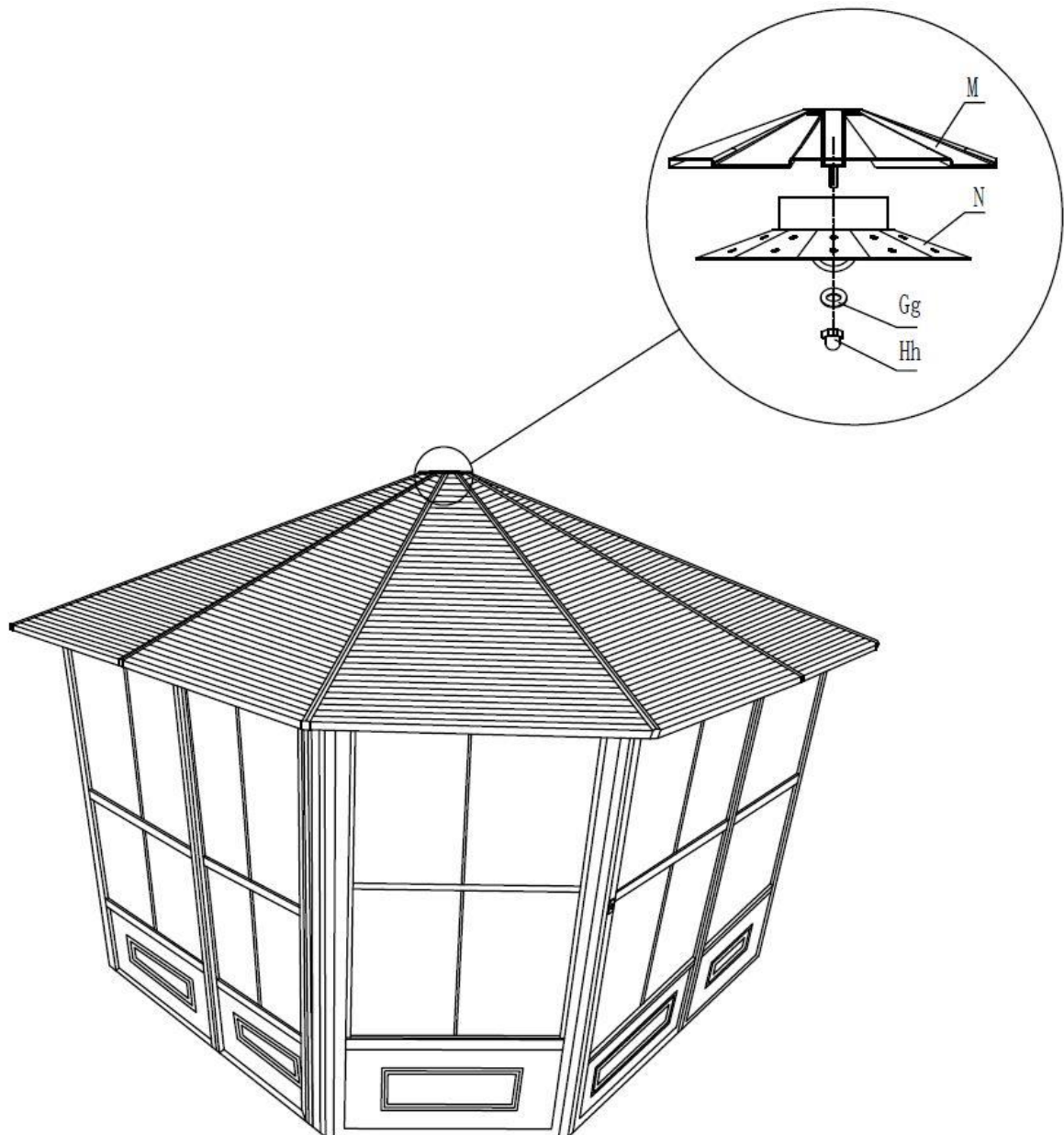

**Step 16:**

1. Inside each of the frames panels, push two Plastic Plugs (Ii) into the ground, and secure the unit by using two Screws (Ee) for each panel or use any other type of anchoring suitable for the floor that you are using.

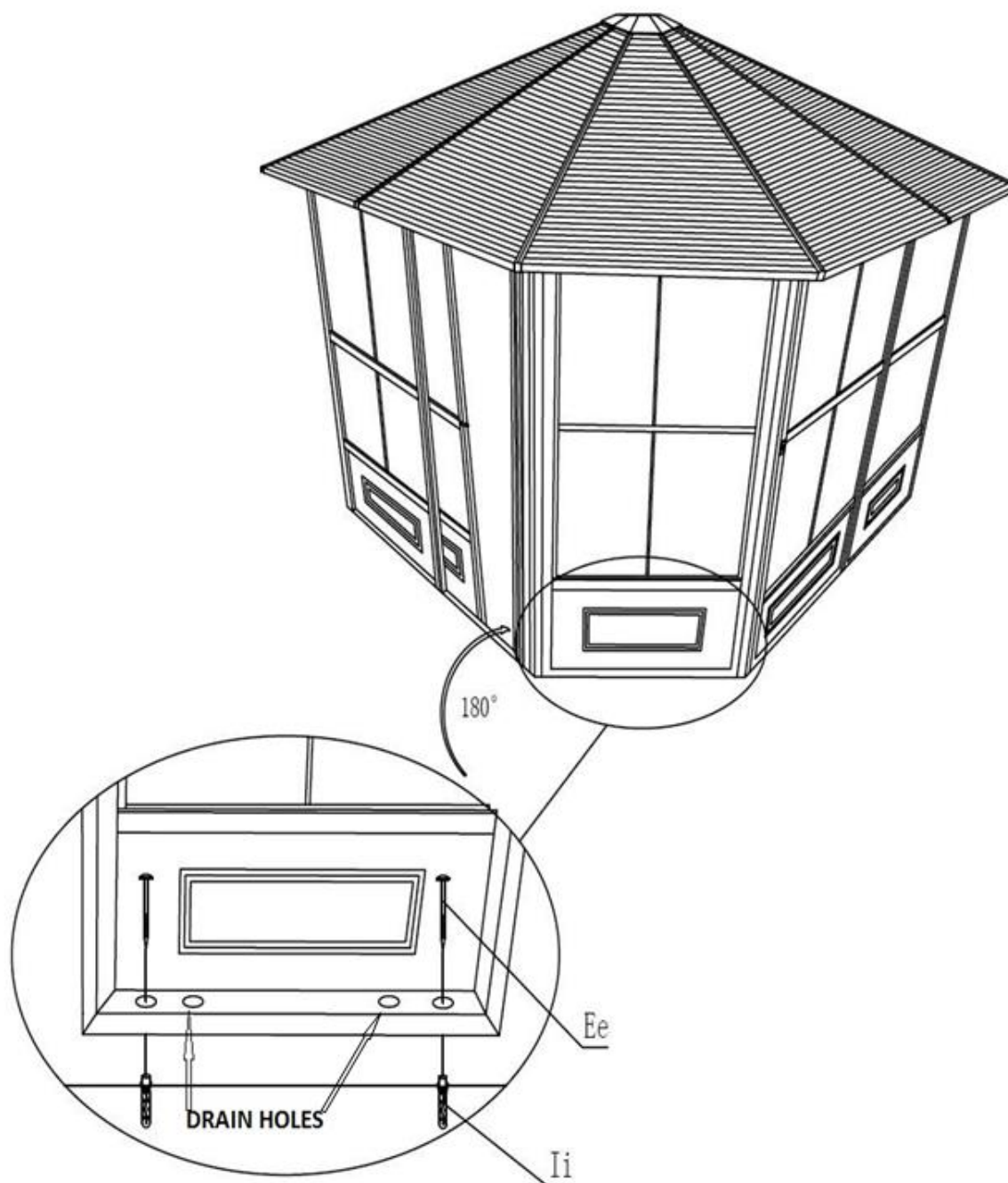

## **\*Suggestions**

The below mentioned are only suggestions in order to permit drainage, these will vary depending on your flooring – material, flatness and slope.

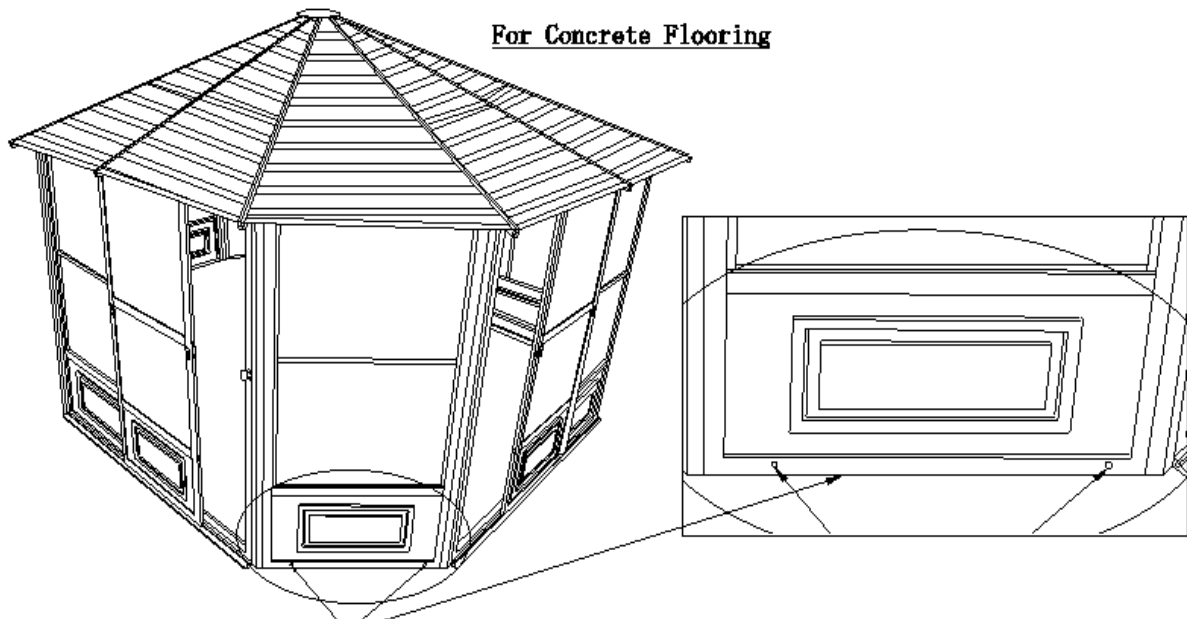

On the outside face, it is suggested to drill holes at the bottom end of the panels to permit drainage when installing on Concrete floor

## **For Wooden Deck**

**Drill through the wooden deck  
where drain holes are located to  
permit drainage**

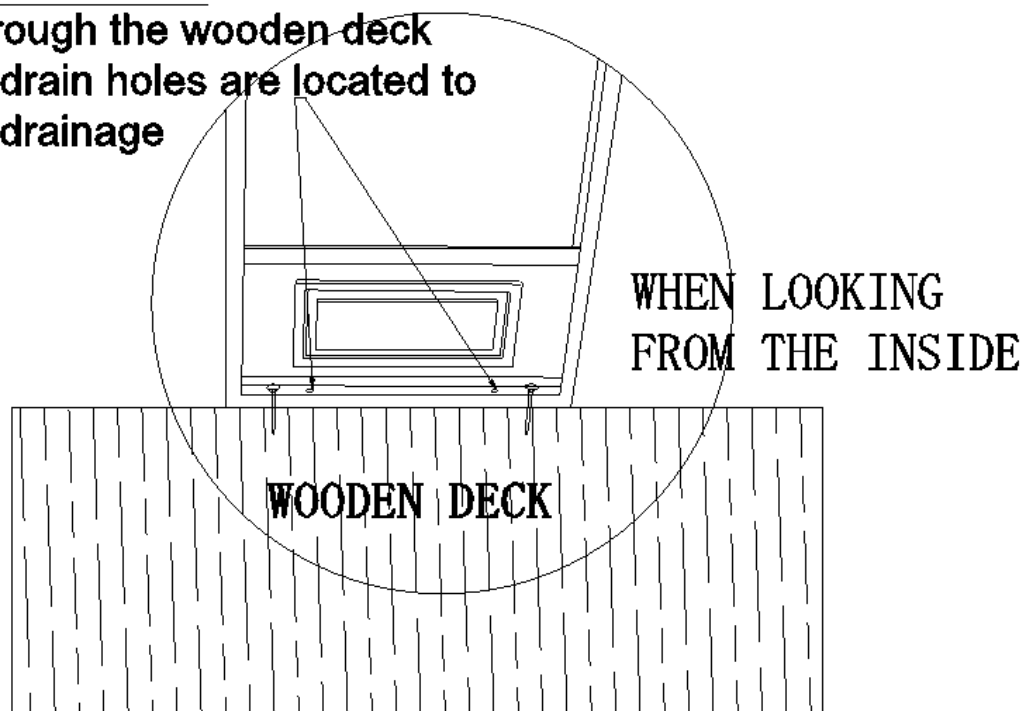

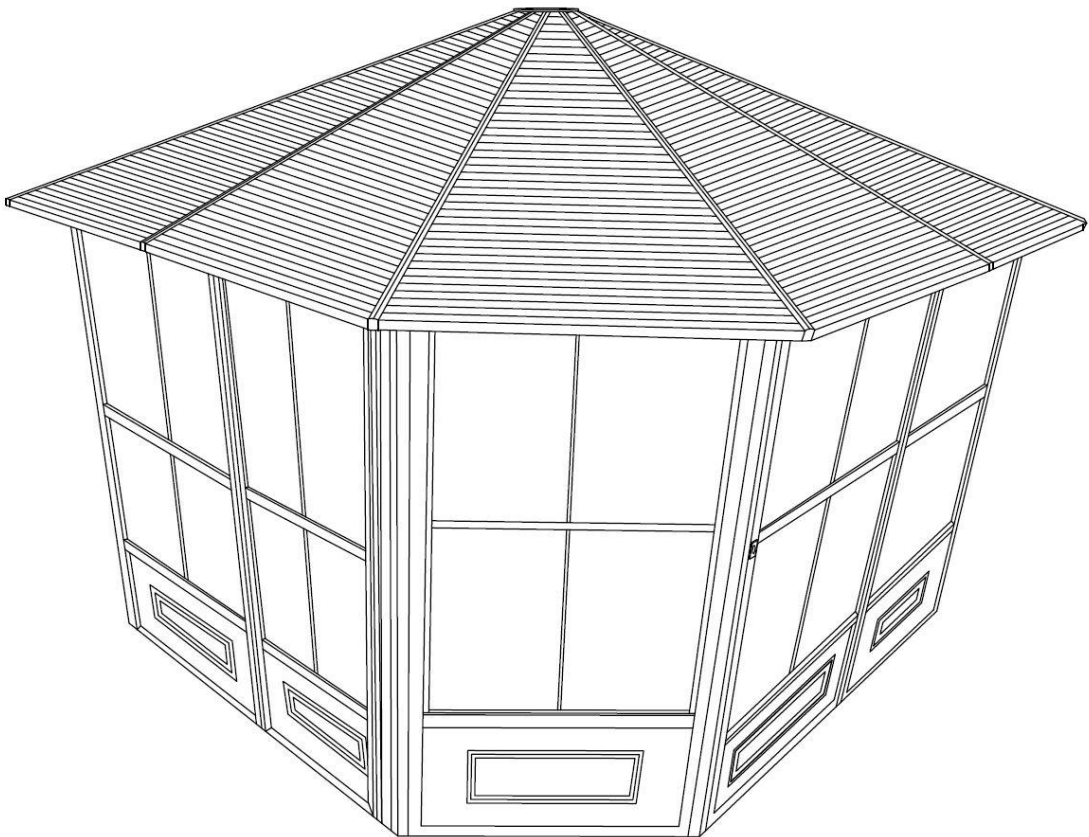
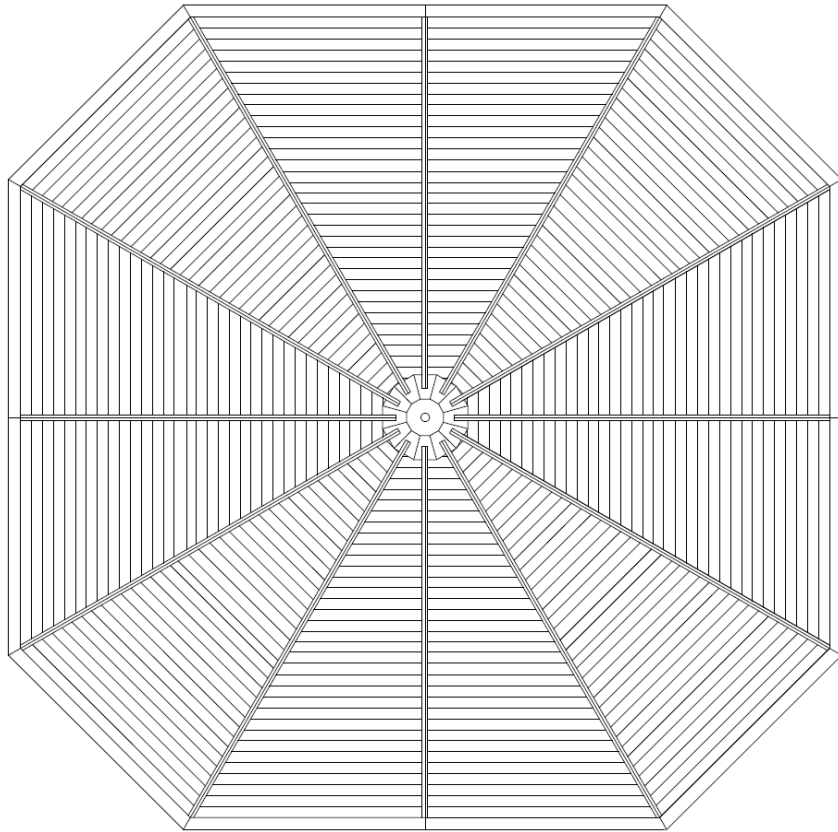

NOTE: The dimensions are approximate.

