



GAZEBO penguin inc.

4660 Hickmore, St-Laurent
Quebec, Canada
H4T 1K2
customerservice@gazebopenguin.com

**PLEASE READ
IN ITS ENTIRETY
BEFORE
INSTALLATION**

**CARPORT
MODEL# 455006-32 GREY
MODEL# 455006-52 WHITE
INSTALLATION MANUAL**

**PLEASE READ
IN ITS ENTIRETY
BEFORE
INSTALLATION**

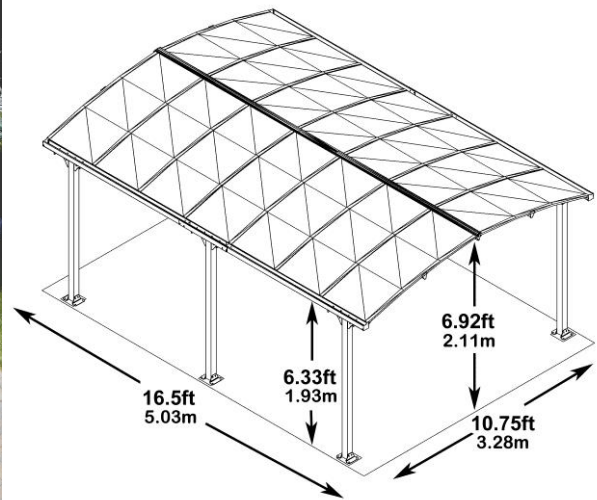

**DO NOT DESTROY THE BOXES UNTIL COMPLETELY ASSEMBLED
PLEASE VERIFY THE CONTENT OF EACH BOX AGAINST THE LIST OF PARTS**

Three adults required for assembly

Dimensions:

Overall: 16.5ft x 11.83ft x 7.75ft (503cm x 361cm x 236cm)
Base: 14.83ft x 11.67ft (451cm x 355cm)
Interior: 10.75ft x 6.33ft to 6.92ft clearance (328cm wide x 193 to 211cm)

Tools required (not provided):

6ft (1.8m) stepladder, metric wrench set & Allen keys, Phillips screwdriver, power drill with 4mm (1/8in) drill bit, level, tape measure, mallet, safety gloves & glasses, hard hat, tarp or protective material for placing parts on during assembly.

VOIR PAGE 18 POUR LES INSTRUCTIONS EN FRANÇAIS

11.83ft x 16.5ft / 3.61m x 5.03m Carport Instruction Manual

**DO NOT DESTROY THE BOXES UNTIL COMPLETELY ASSEMBLED
PLEASE VERIFY THE CONTENT OF EACH BOX AGAINST THE LIST OF PARTS**

IMPORTANT: RETAIN FOR FUTURE REFERENCE, READ CAREFULLY

Consult with your local governing authority / local municipal codes regarding installation of temporary structures before purchase or assembly. Some jurisdictions may require permits for, or otherwise regulate, installation and use.

For assistance with assembly, installation, parts, or customer service, contact Gazebo Penguin Customer Service Department at the numbers listed below (English & French, Mon-Fri 8:00AM to 4:00PM EST):

Montreal: (514) 276-3485



Elsewhere in Canada and the US: 1-800-737-7174

WARNING:

- For outdoor use.
- Snow should be regularly cleared from the roof and not allowed to accumulate.



PRIOR TO ASSEMBLY:

- Choose the site for your carport carefully.
- The foundation must be level, flat, and solid, such as concrete or asphalt.
- Keep away from overhead utility lines, tree branches, and other structures.
- Check for underground pipes or wires if digging or drilling is required.
- Do not install near roof lines or other structures that could shed snow, ice, or excessive rain run-off onto the carport.
- Assemble the carport as close to its final location as possible.
- It is recommended to wear safety gloves, safety glasses, and hard hats for installation.
- Do not hang from, climb on, or stand on the structure or roof.
- Before assembly, read instructions and check that all parts are present in the boxes. If any parts are missing, refer to warranty information on pg 15.
- A 6ft (1.8m) stepladder, metric wrenches & Allen keys, Phillips screwdriver, tape measure, level, mallet, tarp to place parts on, and a power drill with 4mm (1/8in) drill bit will be required for assembly (not included).
- **Remove top protective film from roof panels prior to assembly; DO NOT remove bottom protective film until ready to insert roof panels, so as to identify which side is on top.**
- Please note that the included wrench (11-765) can be used for all 10mm nuts when tightening.
- Please note some parts should be fastened by hand to start,  and then tightened with a wrench at a later step. 

ANCHORING INSTRUCTIONS:

- Proper anchoring of the frame is required for safety.
- Any structure not anchored securely has the potential to fly away during high wind causing damage and safety hazard.
- How the item is anchored, and the hardware and tools required, will vary based upon the set up location and are not included. Please check with your local hardware store for the appropriate anchors.
- Do not anchor to pavers / pavement slabs because they are not a solid foundation.
- Periodically check the anchors to ensure they remain secure.

CARE AND MAINTENANCE:

- In case of a defective or damaged part, or for any other questions concerning the product, please contact the manufacturer directly.
- Please have the parts list and part numbers on hand when ordering or requesting replacement parts.











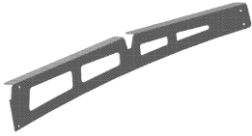

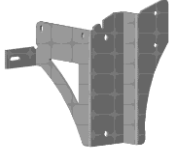
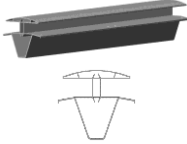
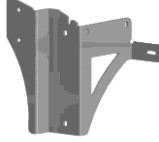
ROOF PANELS:

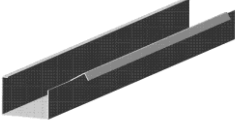

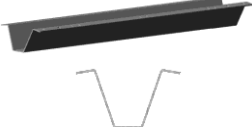

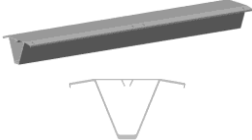
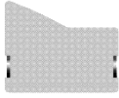

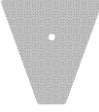



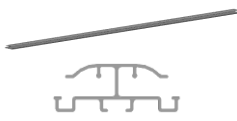

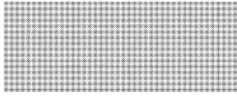

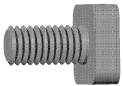



- Gently clean with an environmentally-friendly soap solution and water using a sponge or washcloth.
- Do not use abrasive materials, wire brushes, chemicals, harsh cleaners, or bleach.
- Rinse using a garden hose and air dry. If removed, ensure thoroughly dry prior to storage.
- Do not use pressure washer.













STRUCTURE:

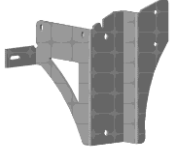
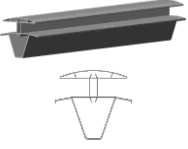
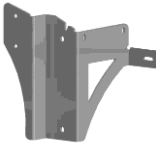
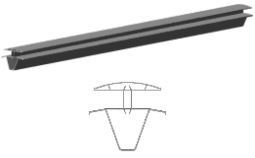
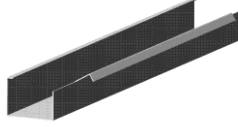

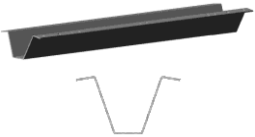

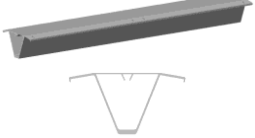
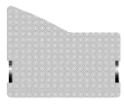

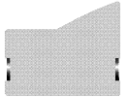
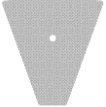



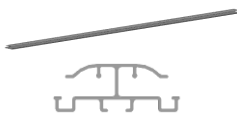

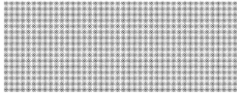

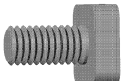

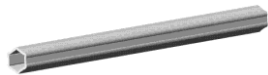
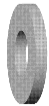

- Gently clean with an environmentally-friendly soap solution and water using a sponge or washcloth.
- Do not use abrasive materials, wire brushes, chemicals, harsh cleaners, or bleach.
- Rinse using a garden hose and air dry.
- Do not use pressure washer.
- If there are nicks, chips, and/or scratches, go to your local hardware store or home center and obtain a closest match touch-up paint suitable for outdoor metal use. Follow instructions that come with the paint.

455006-32 SLATE (SEE PAGE 5 FOR WHITE)

DESCRIPTION	PACKED IN BOX	QTY	DRAWING	DESCRIPTION	PACKED IN BOX	QTY	DRAWING
(11-741-32) LEG POST A	3	6		(11-742-32) RIGHT ROOF TRUSS H-1	3	3	
(11-757-32) FLOOR BRACKET B	3	12		(11-743-32) LEFT ROOF TRUSS H-2	3	3	
(11-755-32) LEFT LEG BRACKET C	3	6		(11-753-32) CENTER MID BEAM I	2	1	
(11-756-32) RIGHT LEG BRACKET D	3	6		(11-752-32) CENTER BEAM I-1	2	2	
(11-748-32) GUTTER JUNCTION E	2	2		(11-760-32) CENTER BEAM PLATE I-2	3	2	
(11-746-32) RIGHT GUTTER E-1	2	2		(11-754-32) BEAM JUNCTION J	2	3	
(11-747-32) LEFT GUTTER E-2	2	2		(11-751-32) SIDE MID BEAM L	2	2	
(13-041-32) GUTTER END PLATE F-1	3	2		(11-750-32) SIDE BEAM L-1	2	4	
(13-042-32) GUTTER END PLATE F-2	3	2		(11-761-32) SIDE BEAM PLATE L-2	3	4	
(11-749-32) TRUSS JUNCTION H	3	6		(11-745-32) END RAFTER N	3	4 (packed inside leg)	

DESCRIPTION	PACKED IN BOX	QTY	DRAWING	DESCRIPTION	PACKED IN BOX	QTY	DRAWING
(11-744-32) MAIN RAFTER O	3	12 (packed inside leg)		(11-769-32) ACORN NUT W	3	36 +3 spare	 M8
(11-767-32) ROOF PANEL P 69" X 28"	1	14		(11-770-32) BOLT X	3	84 +3 spare	 M6x16mm
(11-768-32) BOLT M	3	40 +4 spare	 M6x16mm	(11-774-32) WASHER X-1	3	102 +4 spare	 1/4
(11-779-32) NUT M-1	3	142 +5 spare	 M6	(14-044-32) BOLT X-2	3	18 +1 spare	 M6x22mm
(11-777-32) WASHER Q-1	3	72 +4 spare	 M8	(11-778-32) SCREW Y	3	8 +1 spare	
(11-783-32) BOLT S	3	12 +1 spare	 M10*25mm	(11-765-32) WRENCH Z	3	1	
(11-784-32) WASHER S-1	3	24 +2 spare	 M10	(11-771-32) BOLT Aa	3	56 +3 spare	 M4x16mm
(11-785-32) ACORN NUT S-2	3	12 +1 spare	 M10	(11-772-32) NUT Aa-1	3	56 +3 spare	 M4
(11-773-32) BOLT T	3	24 +1 spare	 M8*100mm	(11-776-32) LOCK WASHER Aa-2	3	56 +3 spare	 M4
(11-782-32) BOLT U	3	12 +1 spare	 M8*25mm	(11-775-32) WASHER V	3	12 +1 spare	 M8

DESCRIPTION	PACKED IN BOX	QTY	DRAWING	DESCRIPTION	PACKED IN BOX	QTY	DRAWING
(11-741-52) LEG POST A	3	6		(11-742-52) RIGHT ROOF TRUSS H-1	3	3	
(11-757-52) FLOOR BRACKET B	3	12		(11-743-352) LEFT ROOF TRUSS H-2	3	3	
(11-755-52) LEFT LEG BRACKET C	3	6		(11-753-352) CENTER MID BEAM I	2	1	
(11-756-52) RIGHT LEG BRACKET D	3	6		(11-752-52) CENTER BEAM I-1	2	2	
(11-748-52) GUTTER JUNCTION E	2	2		(11-760-52) CENTER BEAM PLATE I-2	3	2	
(11-746-52) RIGHT GUTTER E-1	2	2		(11-754-52) BEAM JUNCTION J	2	3	
(11-747-52) LEFT GUTTER E-2	2	2		(11-751-52) SIDE MID BEAM L	2	2	
(13-041-52) GUTTER END PLATE F-1	3	2		(11-750-52) SIDE BEAM L-1	2	4	
(13-042-52) GUTTER END PLATE F-2	3	2		(11-761-52) SIDE BEAM PLATE L-2	3	4	
(11-749-52) TRUSS JUNCTION H	3	6		(11-745-52) END RAFTER N	3	4 (packed inside leg)	

DESCRIPTION	PACKED IN BOX	QTY	DRAWING	DESCRIPTION	PACKED IN BOX	QTY	DRAWING
(11-744-52) MAIN RAFTER O	3	12 (packed inside leg)		(11-769-52) ACORN NUT W	3	36 +3 spare	 M8
(11-767-52) ROOF PANEL P 69" X 28"	1	14		(11-770-52) BOLT X	3	84 +3 spare	 M6x16mm
(11-768-52) BOLT M	3	40 +4 spare	 M6x16mm	(11-774-52) WASHER X-1	3	102 +4 spare	 1/4
(11-779-52) NUT M-1	3	142 +5 spare	 M6	(14-044-52) BOLT X-2	3	18 +1 spare	 M6x22mm
(11-777-52) WASHER Q-1	3	72 +4 spare	 M8	(11-778-52) SCREW Y	3	8 +1 spare	
(11-783-52) BOLT S	3	12 +1 spare	 M10*25mm	(11-765-52) WRENCH Z	3	1	
(11-784-52) WASHER S-1	3	24 +2 spare	 M10	(11-771-52) BOLT Aa	3	56 +3 spare	 M4x16mm
(11-785-52) ACORN NUT S-2	3	12 +1 spare	 M10	(11-772-52) NUT Aa-1	3	56 +3 spare	 M4
(11-773-52) BOLT T	3	24 +1 spare	 M8*100mm	(11-776-52) LOCK WASHER Aa-2	3	56 +3 spare	 M4
(11-782-52) BOLT U	3	12 +1 spare	 M8*25mm	(11-775-52) WASHER V	3	12 +1 spare	 M8

STEP 01A:

(Pieces: **A** x6, **B** x12, **C** x6, **D** x6)

(Hardware: **T** x24, **Q-1** x48, **W** x24 for 6 legs total)

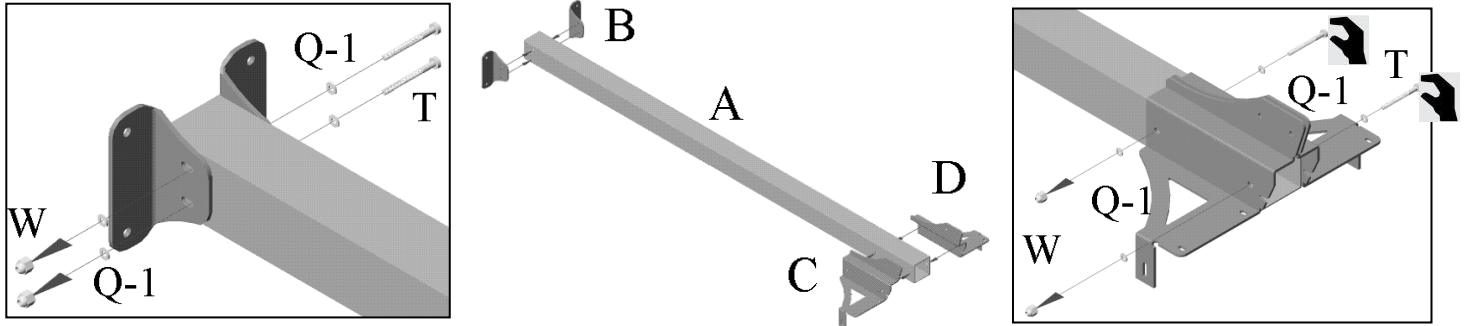

x6

STEP 01B:

(Pieces: **E** x2, **E-1** x2, **E-2** x2, **F-1** x2, **F-2** x2, silicone for sealing (not supplied))

(Hardware: **X** x24, **X-1** x24, **M-1** x24 for 2 gutters total)

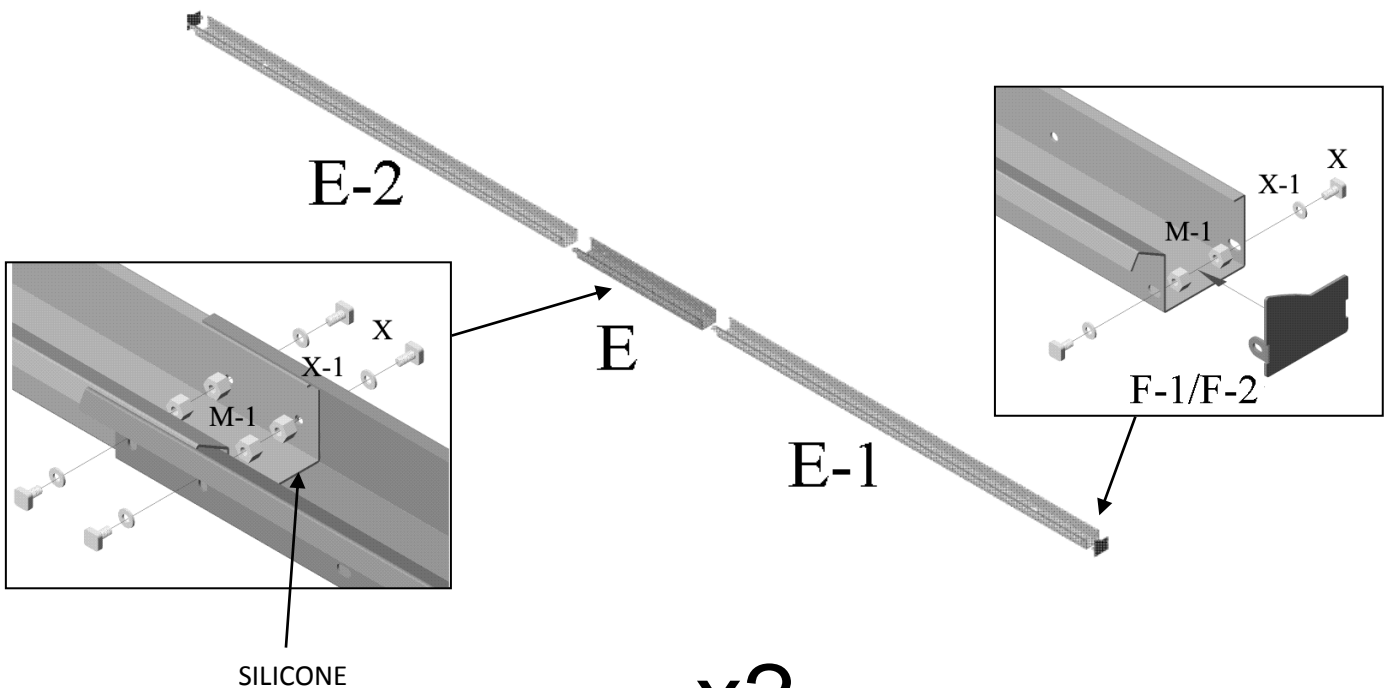

x2

STEP 01C:

(Pieces: **H** x6, **H-1** x3, **H-2** x3)

(Hardware: **S** x12, **S-1** x24, **S-2** x12 for 3 sets of braces total)

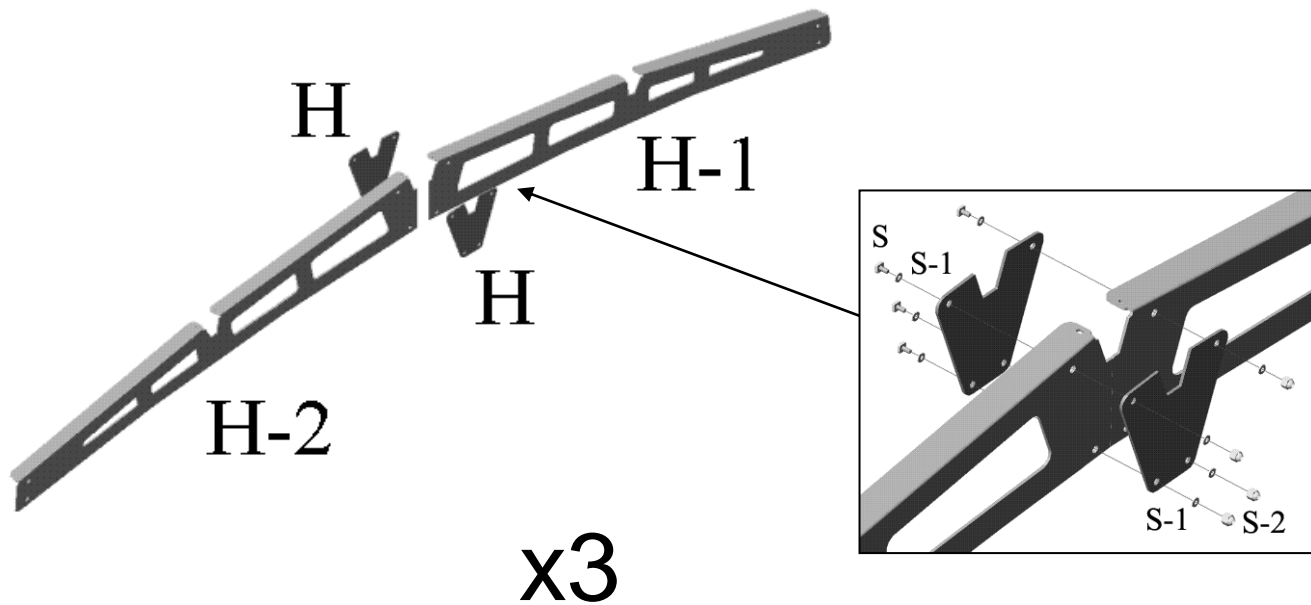

STEP 01D:

(Pieces: **I** x1, **I-1** x2, **I-2** x2, **J** x1)

(Hardware: **X** x12, **X-1** x12, **M-1** x12, **Y** x4)

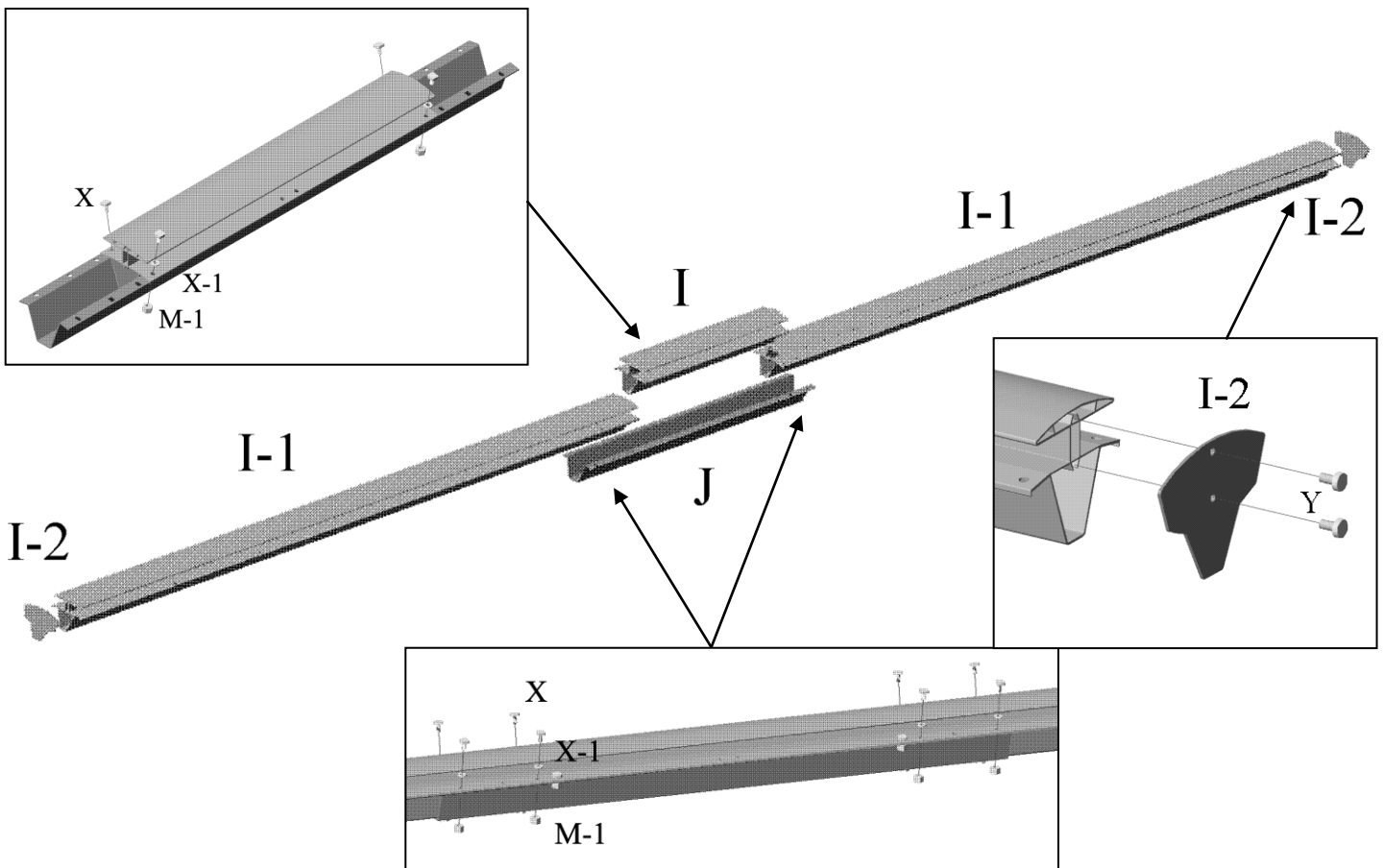

STEP 01E:

(Pieces: L x2, L-1 x4, L-2 x4, J x2)

(Hardware: X x24, X-1 x24, M-1 x24, Y x4 for 2 side beams total)

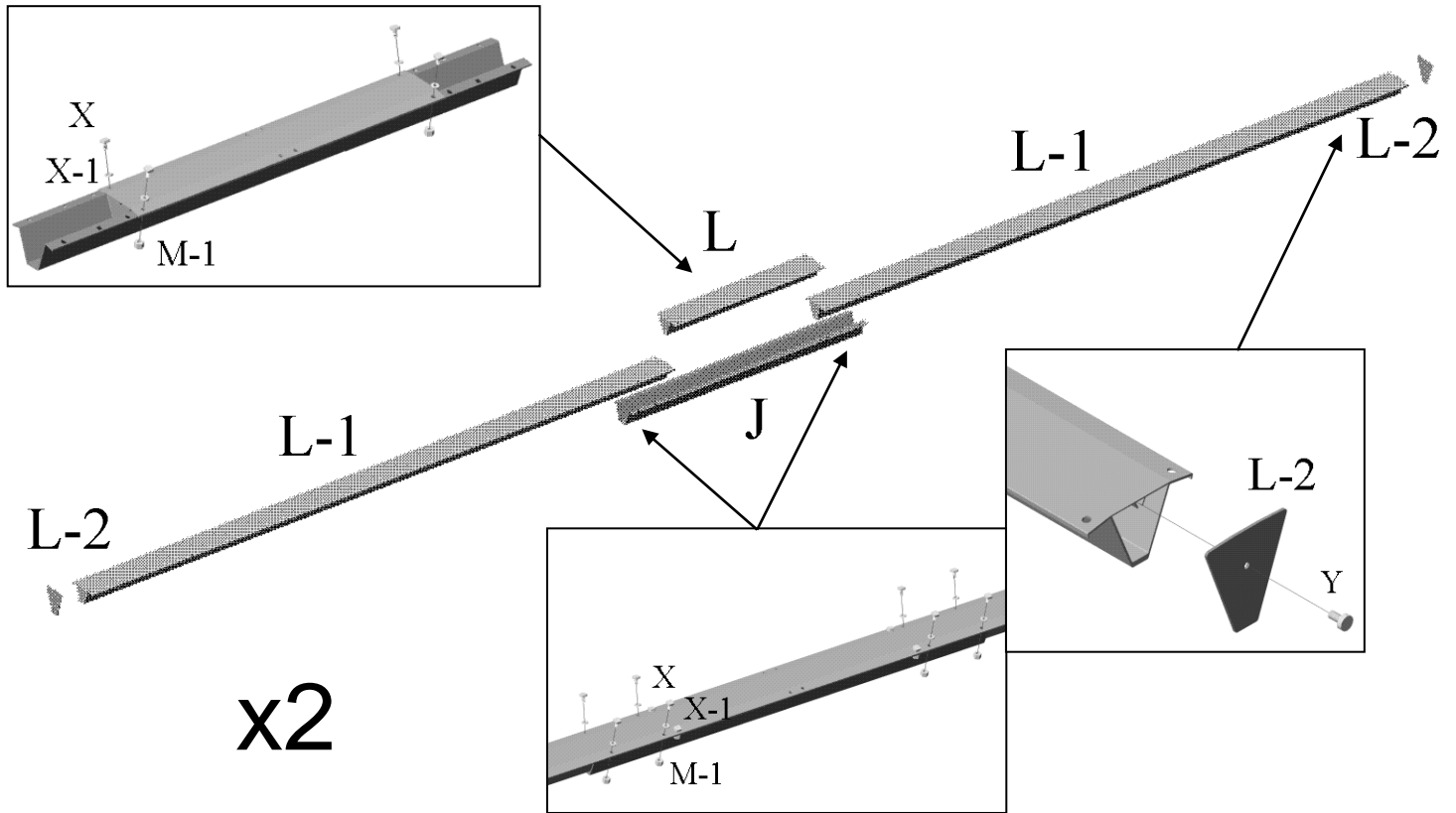

STEP 02:

(Hardware: X-2 x6, X-1 x6, V x4, M-1 x6)

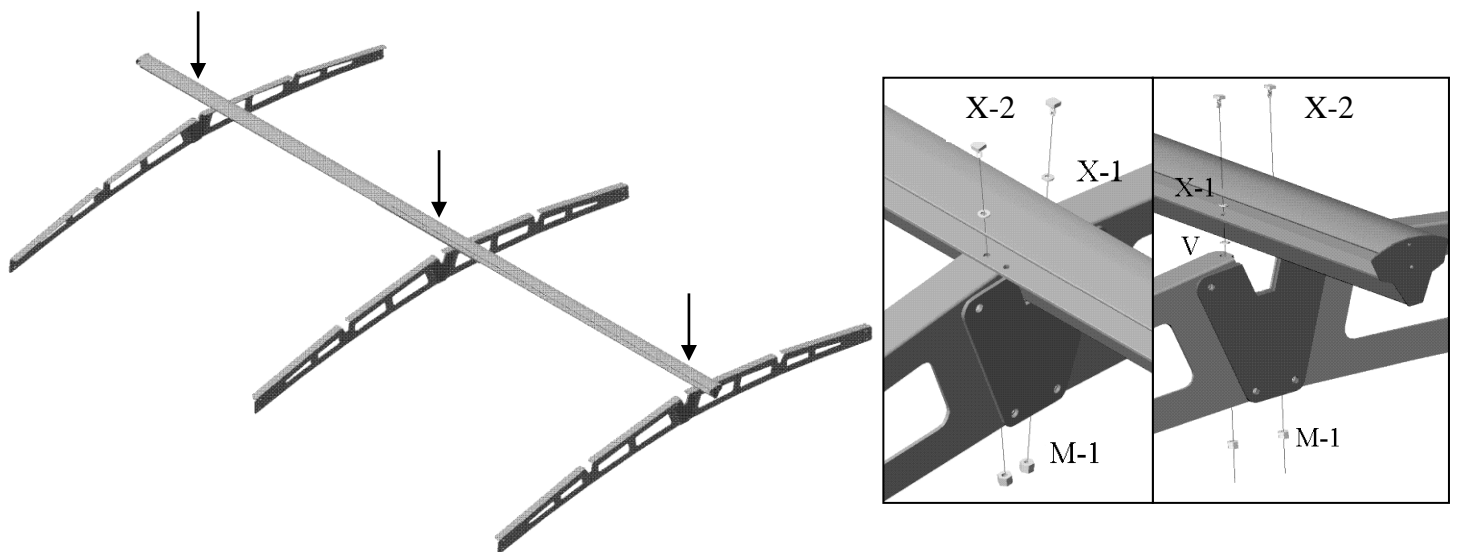

STEP 03:

(Hardware: **X-2** x12, **X-1** x12, **V** x8, **M-1** x12 for 2 side beams total)

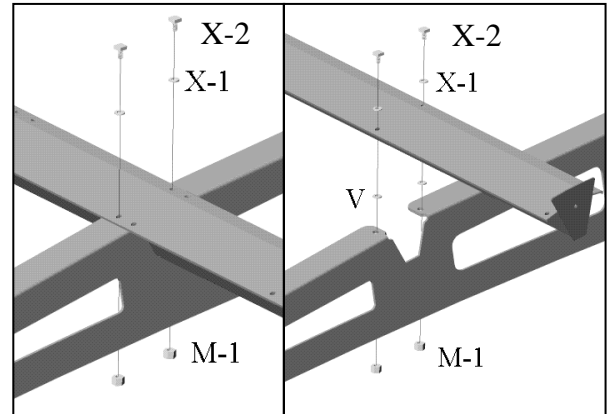
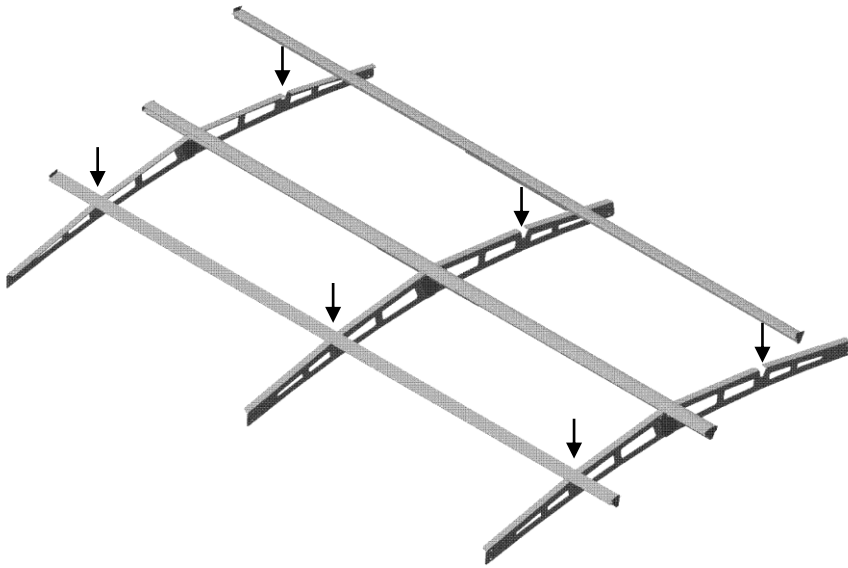

STEP 04:

(Hardware: **U** x6, **Q-1** x12, **W** x6 for 3 sets of braces total)

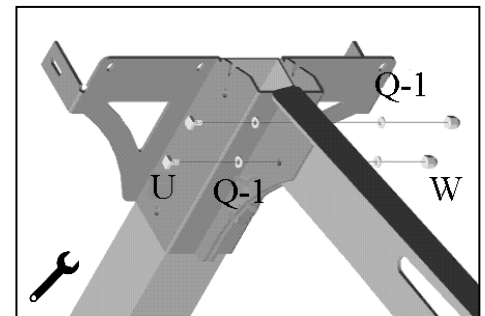
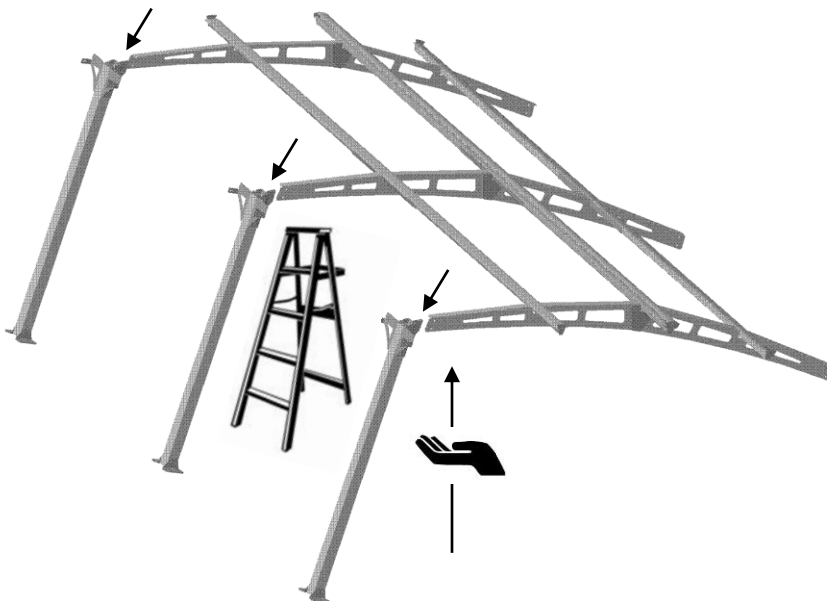

STEP 05:

(Hardware: **X** x12, **X-1** x12, **M-1** x12)

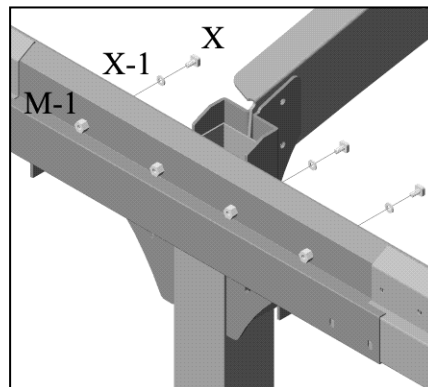

STEP 06:

(Hardware: **U** x6, **Q-1** x12, **W** x6 for 3 sets of braces total)

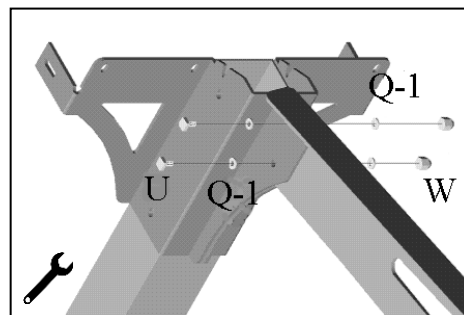
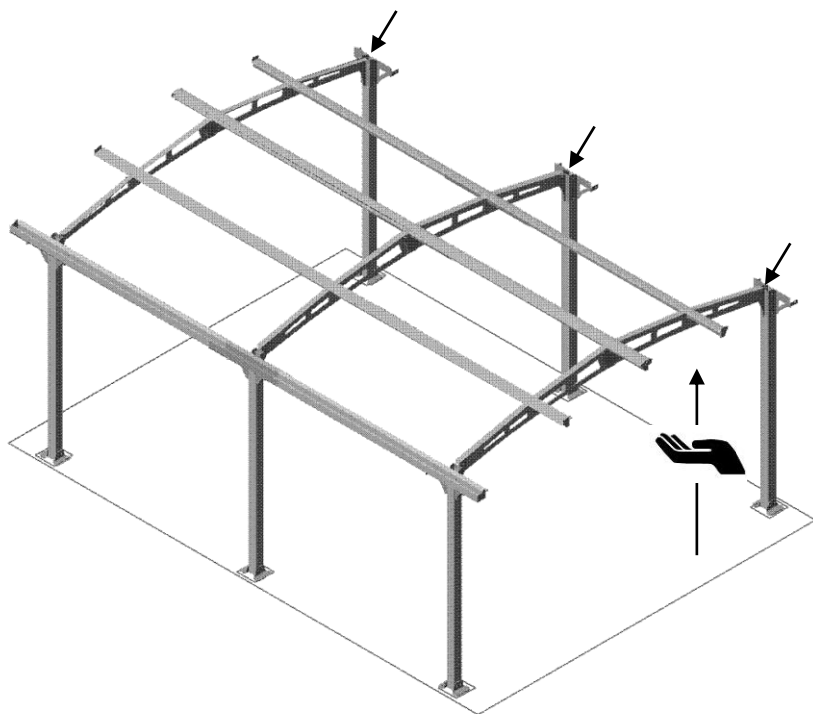

STEP 07:

(Hardware: **X** x12, **X-1** x12, **M-1** x12)

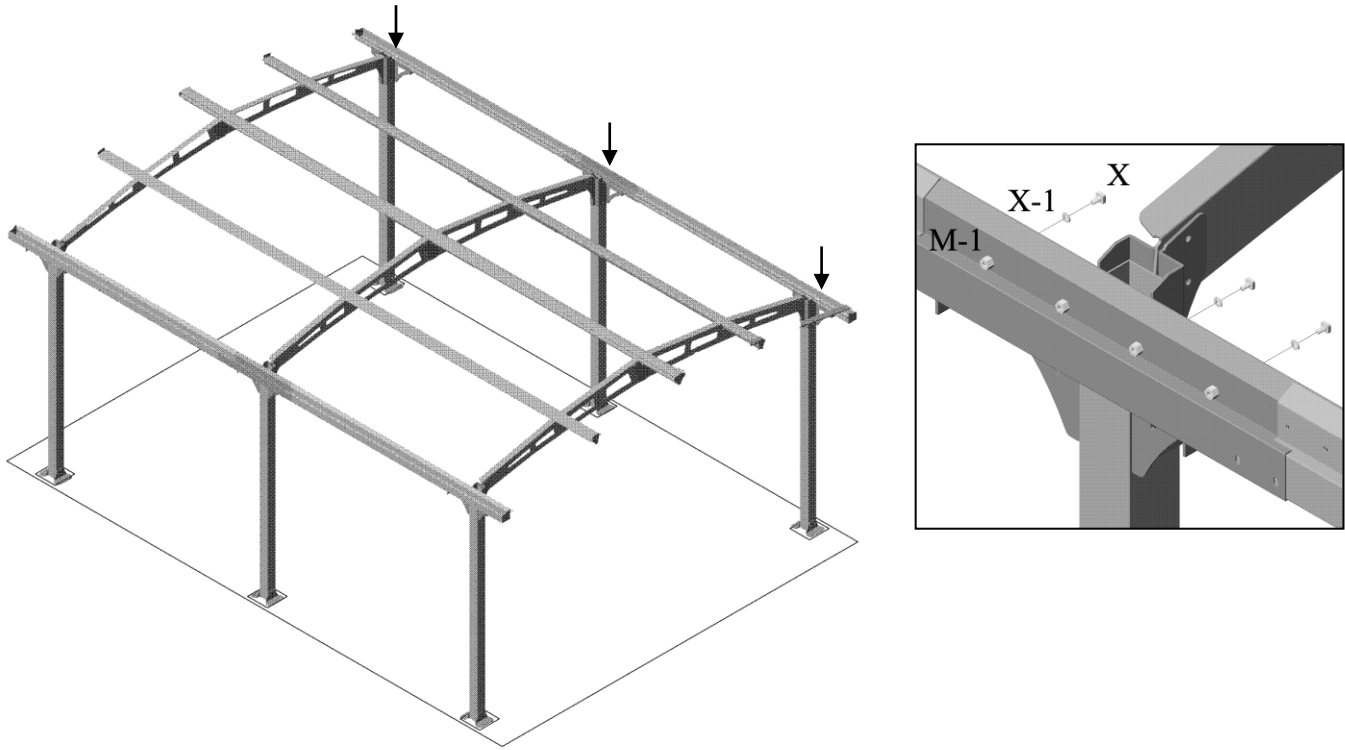

STEP 08:

(Hardware: **M** x16, **M-1** x16)

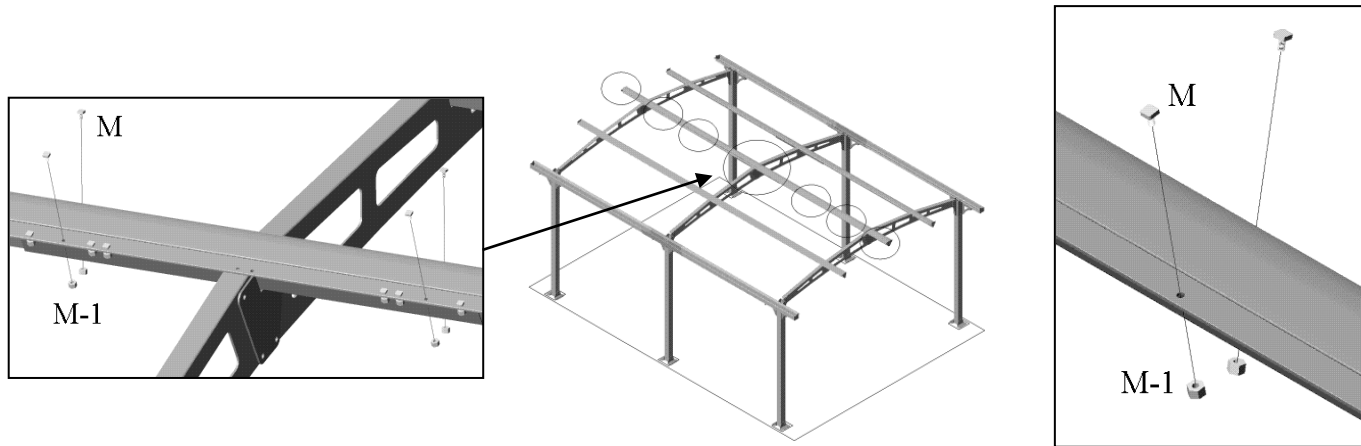

STEP 09:

(Pieces: **N** x4, **O** x12)

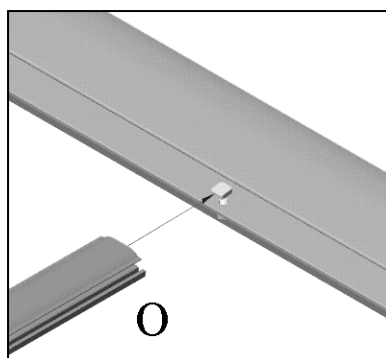
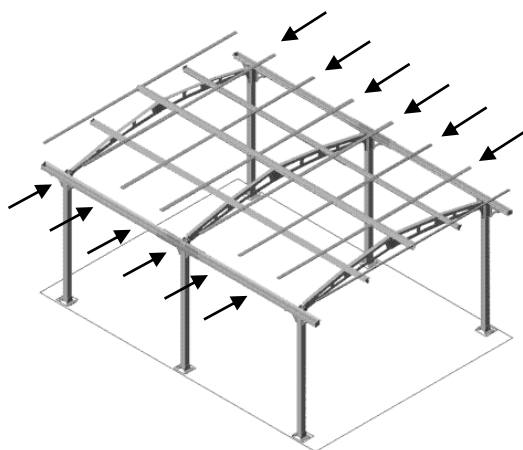
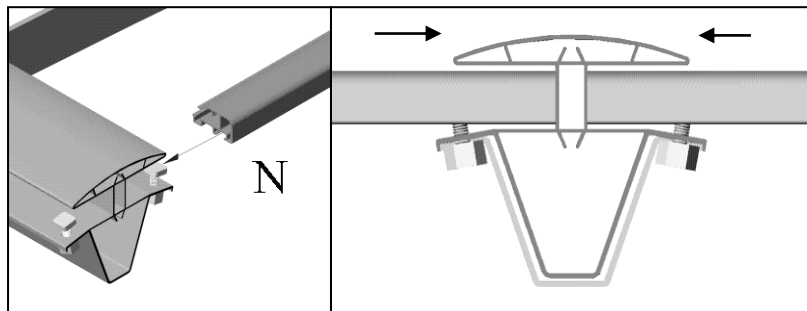
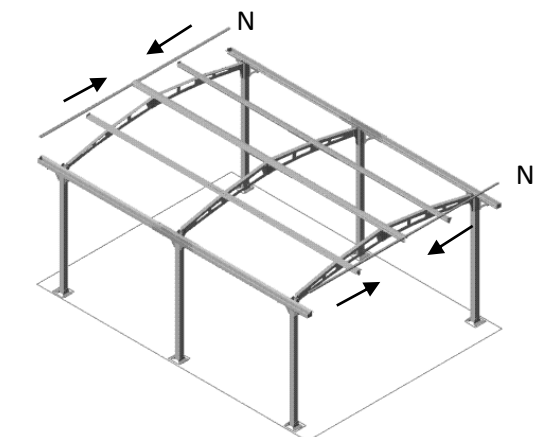

STEP 10:

At this point, verify that each of the legs is vertical and correctly located, and securely tighten any bolts that have been left loose. 

STEP 11:

(Pieces: **P** x14)

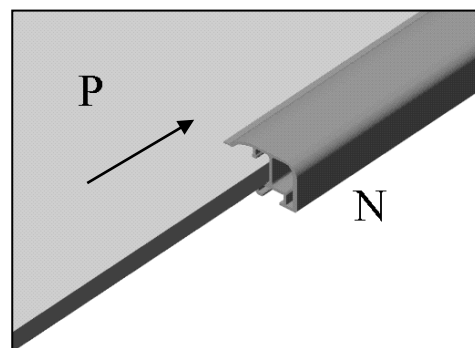
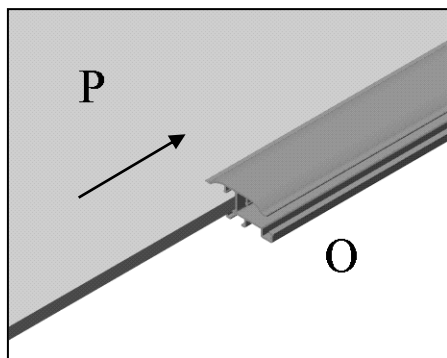
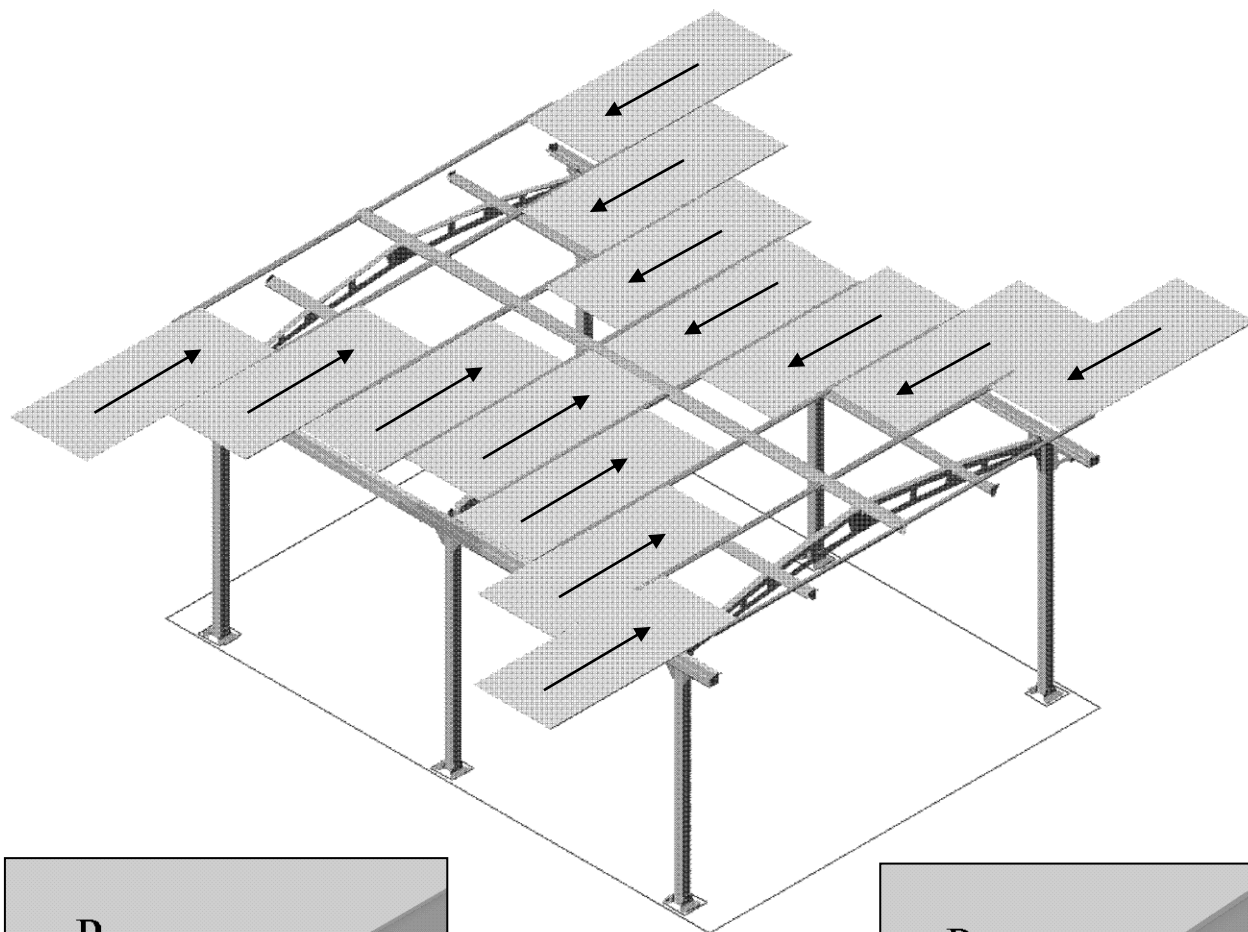

STEP 12:

(Hardware: **M** x12 into end rafters; **M** x12 into main rafters; **M-1** x24)

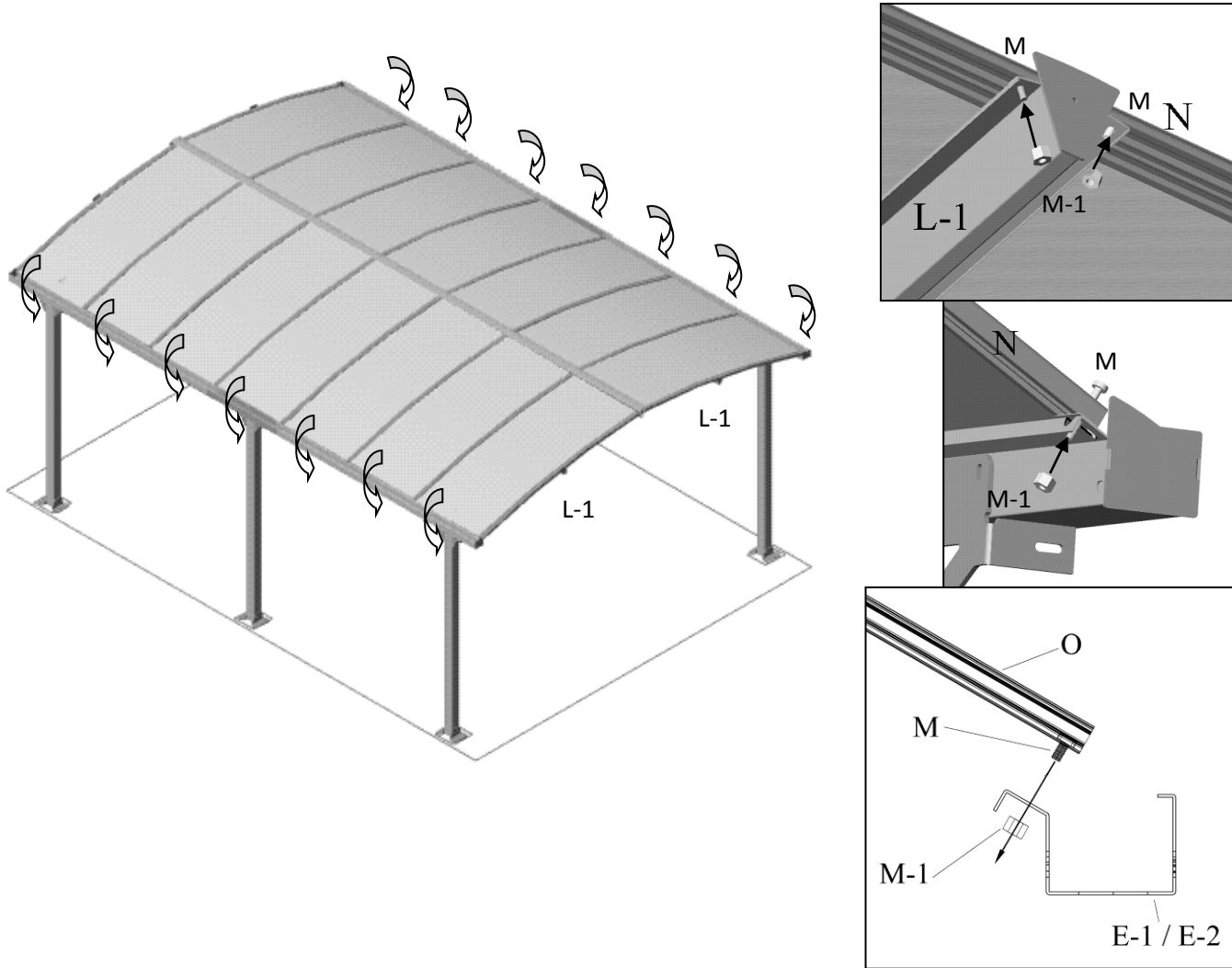

STEP 13:

Anchor the unit as appropriate to your foundation. Anchoring hardware and tools not supplied with this unit.

STEP 14:

(Hardware: **Aa** x56; **Aa-1** x56; **Aa-2** x56 for 14 roof panels total)

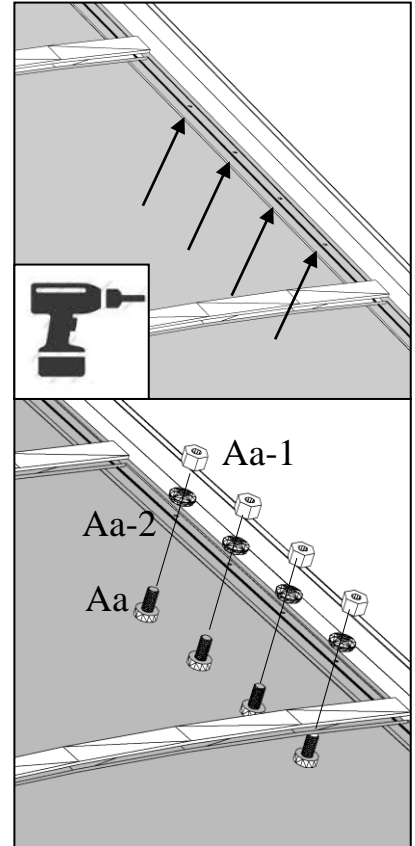
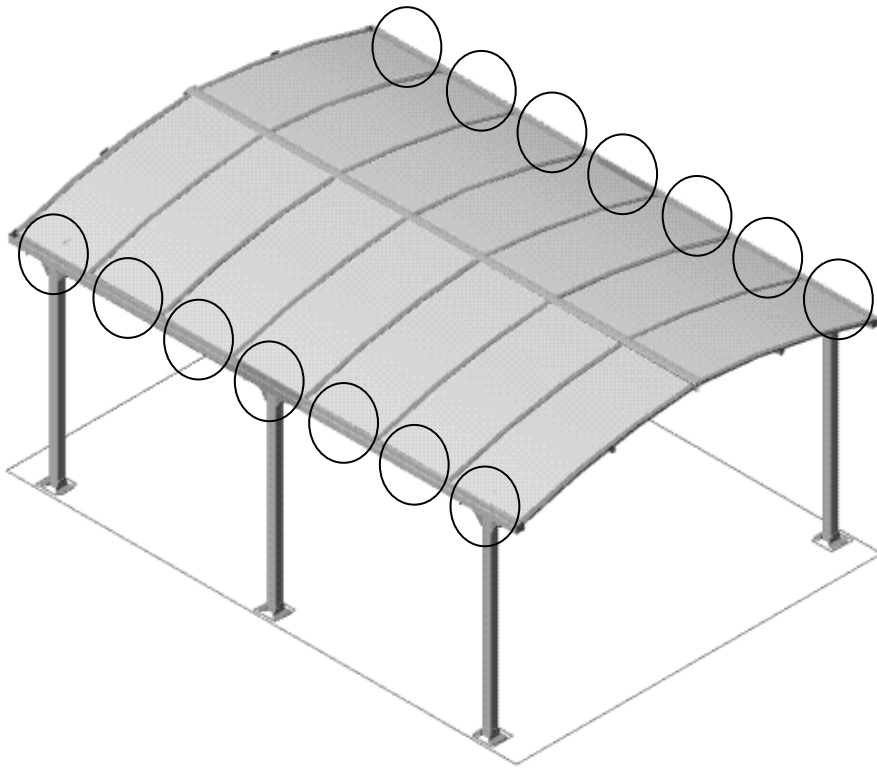

MAINTENANCE NOTES

1. In case of a defective or damaged part, or for any other questions concerning the product, please contact the manufacturer directly.
2. Please have the parts list and part numbers on hand when ordering or requesting replacement parts.
3. The product should not be installed adjacent to trees or a sloped roof. Snow and ice may slide onto the roof and cause it to collapse.
4. While the product is designed to stay assembled year long, the roof must be kept free of accumulation of snow.



ONE YEAR LIMITED WARRANTY

This product has been designed and manufactured to meet the highest standards of quality and durability. Subject to the Conditions for Exercising the Warranty and the Limitations on the Warranty set forth below, it is warranted to be free of material and manufacturing defects for a period of **one year** from the date of purchase. Missing and damage due to transportation is not covered by the manufacture warranty. Should the product become damaged, or the warranty period has expired, please contact Gazebo Penguin Customer Service Department for a complete schedule of replacement parts and prices.

CONDITIONS FOR EXERCISING THE WARRANTY

In order to properly exercise your warranty, please comply with the following:

Carefully inspect the contents of the carton for missing or damaged components. Should you discover damaged or missing parts, **do not return the product to the place of purchase**, but contact Gazebo Penguin Customer Service Department at the numbers listed below (English, French & Spanish, Mon-Fri 8:00AM to 4:00PM EST): **Reference: SUN.150305**

Montreal: (514) 276-3485

Elsewhere in Canada and the US: 1-800-737-7174

You can also find a claim form to fill out online:

<https://abrispenguin.com/assemblyinstructions/>

NOTE: Damages/missing parts must be reported within 30 days of delivery. If claimed after your request might be rejected.

LIMITATIONS ON THE WARRANTY

1. The product is not warranted against damages due to vandalism, abuse, or falling or thrown objects.
2. The product is not warranted against damages due to extreme weather conditions, such as thunderstorms, hail, strong wind or snow storms, or any other acts of God.
3. The product is only warranted in the event it is installed in accordance with the Gazebo Penguin's written instructions enclosed with the product.
4. The product is not warranted in the event it has been improperly anchored.
5. We reserve the right to replace or repair any defective product or parts at our discretion.
6. No change to the unit is allowed. This will void your warranty.



GAZEBO Penguin inc.

4660 Hickmore, St-Laurent
Quebec, Canada
H4T 1K2
customerservice@gazebopenguin.com

**S.V.P LIRE
DANS SON
INTÉGRALITÉ
AVANT
INSTALLATION**

**ABRI D'AUTO
MODÈLE # 455006-32 GRIS
MODÈLE # 455006-32 BLANCHE**

**S.V.P LIRE
DANS SON
INTÉGRALITÉ
AVANT
INSTALLATION**

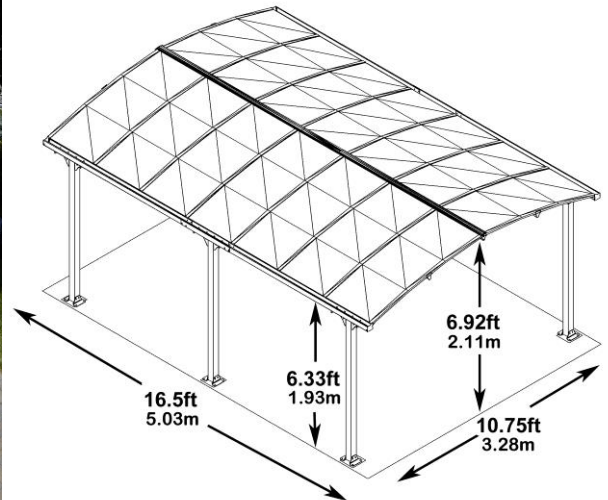

**NE DÉTRUISEZ PAS LES BOÎTES AVANT QUE L'ABRI SOIT COMPLÈTEMENT ASSEMBLÉ
VEUILLEZ VÉRIFIER LE CONTENU DE CHAQUE BOÎTE A L'AIDE DE LA LISTE DES PIÈCES**

Trois adultes sont requis pour l'installation

Dimensions:

Global: 16.5pi x 11.83pi x 7.75pi (503cm x 361cm x 236cm)

Base: 14.83pi x 11.67pi (451cm x 355cm)

Intérieur: 10.75pi x 6.33pi à 6.92cm de clairance (328cm large x 193 à 211cm de clairance)

Outils requis (pas inclus):

Escabeau 6pi (1.8m), clés de serrage & clés Allen métriques, tournevis Phillips, perceuse électrique avec foret 4mm (1/8po), niveau, mètre à ruban, maillet, gants, lunettes, et casque de sécurité, une bâche pour placer les pièces durant l'assemblage.

11.83pi x 16.5pi / 3.61m x 5.03m Abri

Guide d'installation

**NE DÉTRUISEZ PAS LES BOÎTES AVANT QUE L'ABRI SOIT COMPLÈTEMENT ASSEMBLÉ
VEUILLEZ VÉRIFIER LE CONTENU DE CHAQUE BOÎTE A L'AIDE DE LA LISTE DES PIÈCES**

IMPORTANT: GARDEZ POUR RÉFÉRENCE FUTURE, LISEZ ATTENTIVEMENT

Consultez avec votre gouvernement ou municipalité locale concernant l'installation de structures temporaires avant l'achat ou l'assemblage. Certaines juridictions peuvent requérir un permit, ou autrement règlementer, leur installation et utilisation.

Pour assistance avec l'assemblage, l'installation, pièces, et service à la clientèle, appelez Gazebo Penguin aux numéros ci-dessous (Anglais, Français, et Espagnol, Lun-Ven 8:00 à 16:00 HNE):

Montréal: (514) 276-3485

Ailleurs au Canada et les États-Unis: 1-800-737-7174

AVERTISSEMENT:

- Pour usage à l'extérieur.
- La neige devrait être régulièrement enlevée du toit, et ne devrait pas être laissée à accumuler.

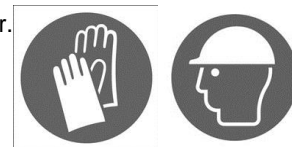

AVANT L'ASSEMBLAGE:

- Choisissez avec attention la location de l'abri.
- La fondation devrait être plate, solide, et à niveau, par exemple en ciment ou en asphalte.
- Gardez loin des lignes électriques, branches d'arbres, et autres structures en surplomb.
- Vérifiez pour les tuyaux ou câbles souterrains s'il est nécessaire de creuser ou de percer des trous.
- N'installez pas près des toits ou autres structures où la neige, la glace, ou l'eau de pluie excessive peuvent tomber sur l'abri.
- Faites l'assemblage de l'abri aussi près de l'emplacement final que possible.
- Il est recommandé de porter des gants, des lunettes, et des casques de sécurité pour l'installation.
- Ne pas vous suspendre de la structure ou du toit, ni grimper ou marcher dessus.
- Avant l'assemblage, lisez attentivement les instructions et vérifiez que toutes les pièces soient présentes dans les boîtes. S'il y a des pièces manquantes, voir l'information sur la garanti à la page 15.
- Un escabeau de 6pi (1.8m), clés métriques et clés Allen, tournevis Phillips, mètre à ruban, niveau, maillet, une bâche pour placer les pièces, et une perceuse avec un foret 4mm (1/8po) seront requises pour l'assemblage (non incluses).
- **Retirer le film protecteur du haut des panneaux de toit avant l'assemblage; NE RETIRER PAS le film protecteur du bas avant l'insertion des panneaux, pour pouvoir différencier le haut et le bas.**
- Notez que la clé (11-765) incluse peut être utilisée pour sécuriser tout les écrous 10mm.

INSTRUCTIONS POUR L'ANCRAGE DE L'ABRI:

- L'ancrage approprié de la structure est nécessaire pour la sécurité.
- Toute structure qui n'est pas ancré correctement peut s'envoler dans les vents forts, causant des dommages et des risques de sécurité.
- La méthode d'ancrage, et la quincaillerie et outils requises, dépendra de la location de l'installation et ne sont pas incluses. Veuillez vérifier avec votre magasin de quincaillerie local pour les ancrages appropriés.
- N'ancez pas la structure à des pavés ou des dalles, car ceux-ci ne sont pas une fondation solide.
- Vérifiez périodiquement pour assurer que les ancrages restent sécurisés.

NOTES D'ENTRETIEN:

- En cas de pièce défectueuse ou endommagée, ou pour toute autre question concernant le produit, veuillez contacter le manufacturier directement.
- Veuillez avoir les numéros de pièces et la liste de pièces en main quand vous commandez les pièces de remplacement.

PANNEAUX DU TOIT:











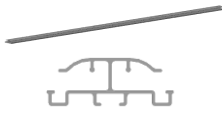



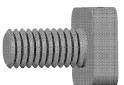





- Nettoyez doucement avec de l'eau et du savon écologiquement sain, avec une éponge ou une débarbouillette.
- N'utilisez pas de matériel abrasif, brosses métalliques, produits chimiques ou javellisants, ou détergents sévères.
- Rincez avec un tuyau d'arrosage et sécher à l'air. Si démontés, assurer que les panneaux soient complètement secs avant l'entreposage.
- N'utilisez pas de nettoyeur à haute pression.









STRUCTURE:

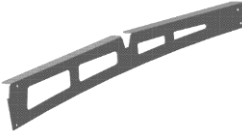

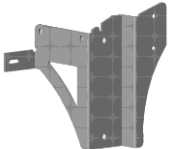
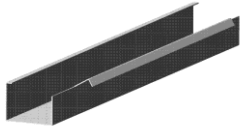

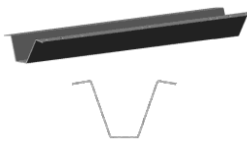

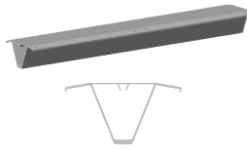
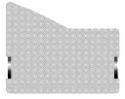
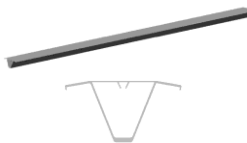
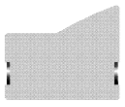



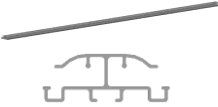

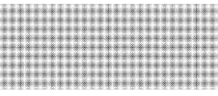

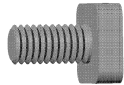

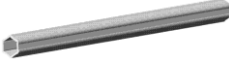

- Nettoyez doucement avec de l'eau et du savon écologiquement sain, avec une éponge ou une débarbouillette.
- N'utilisez pas de matériel abrasif, brosses métalliques, produits chimiques ou javellisants, ou détergents sévères.
- Rincez avec un tuyau d'arrosage et sécher à l'air.
- N'utilisez pas de nettoyeur à haute pression.
- S'il y a des entailles et/ou des égratignures, obtenez de votre magasin de quincaillerie ou centre maison local de la peinture de retouche bonne pour le métal et l'extérieur. Suivez les instructions qui viennent avec la peinture.

455006-32 GRIS (VOIR PAGE 22 POUR BLANCHES PIÈCES)

DESCRIPTION	EMBALLÉ DANS LA BOÎTE	QTÉ	DESSIN	DESCRIPTION	EMBALLÉ DANS LA BOÎTE	QTÉ	DESSIN
(11-741-32) POTEAU A	3	6		(11-742-32) MOITIÉ D'ARCHE DROITE H-1	3	3	
(11-757-32) CROCHET DE BASE B	3	12		(11-743-32) MOITIÉ D'ARCHE GAUCHE H-2	3	3	
(11-755-32) SUPPORT GAUCHE C	3	6		(11-753-32) MI- POUTRE CENTRALE I	2	1	
(11-756-32) SUPPORT DROIT D	3	6		(11-752-32) POUTRE CENTRALE I-1	2	2	
(11-748-32) JOINTURE DE GOUTTIÈRE E	2	2		(11-760-32) PLAQUE CENTRALE I-2	3	2	
(11-746-32) GOUTTIÈRE DROITE E-1	2	2		(11-754-32) JOINTURE DE POUTRE J	2	3	
(11-747-32) GOUTTIÈRE GAUCHE E-2	2	2		(11-751-32) MI- POUTRE LATÉRALE L	2	2	
(11-758-32) PLAQUE DE GOUTTIÈRE F-1	3	2		(11-750-32) POUTRE LATÉRALE L-1	2	4	
(11-759-32) PLAQUE DE GOUTTIÈRE F-2	3	2		(11-761-32) PLAQUE LATÉRALE L-2	3	4	
(11-749-32) JOINTURE D'ARCHE H	3	6		(11-745-32) CHEVRON FINAL N	3	4 (emballé dans poteau)	

DESCRIPTION	EMBALLE DANS LA BOITE	QTÉ	DESSIN	DESCRIPTION	EMBALLE DANS LA BOITE	QTÉ	DESSIN
(11-744-32) CHEVRON PRINCIPAL O	3	12 (emballé dans poteau)		(11-769-32) ÉCROU BORGNE W	3	36 +3 spare	 M8
(11-767-32) PANNEAU DE TOIT P	1	14		(11-770-32) BOULON X	3	84 +3 spare	 M6x16mm
(11-768-32) BOULON M	3	40 +4 spare	 M6x16mm	(11-774-32) RONDELLE X-1	3	102 +4 spare	 1/4
(11-779-32) ÉCROU M-1	3	142 +5 spare	 M6	(14-044-32) BOULON X-2	3	18 +1 spare	 M6x22mm
(11-777-32) RONDELLE Q-1	3	72 +4 spare	 M8	(11-778-32) VIS Y	3	8 +1 spare	
(11-783-32) BOULON S	3	12 +1 spare	 M10*25mm	(11-765-32) CLÉ Z	3	1	
(11-784-32) RONDELLE S-1	3	24 +2 spare	 M10	(11-771-32) BOULON Aa	3	56 +3 spare	 M4x16mm
(11-785-32) ÉCROU BORGNE S-2	3	12 +1 spare	 M10	(11-772-32) ÉCROU Aa-1	3	56 +3 spare	 M4
(11-773-32) BOULON T	3	24 +1 spare	 M8*100mm	(11-776-32) RONDELLE FREIN Aa-2	3	56 +3 spare	 M4
(11-782-32) BOULON U	3	12 +1 spare	 M8*25mm	(11-775-32) RONDELLE V	3	12 +1 spare	 M8

DESCRIPTION	EMBALLÉ DANS LA BOITE	QTÉ	DESSIN	DESCRIPTION	EMBALLÉ DANS LA BOITE	QTÉ	DESSIN
(11-741-52) POTEAU A	3	6		(11-742-52) MOITIÉ D'ARCHE DROITE H-1	3	3	
(11-757-52) CROCHET DE BASE B	3	12		(11-743-52) MOITIÉ D'ARCHE GAUCHE H-2	3	3	
(11-755-52) SUPPORT GAUCHE C	3	6		(11-753-52) MI- POUTRE CENTRALE I	2	1	
(11-756-52) SUPPORT DROIT D	3	6		(11-752-52) POUTRE CENTRALE I-1	2	2	
(11-748-52) JOINTURE DE GOUTTIÈRE E	2	2		(11-760-52) PLAQUE CENTRALE I-2	3	2	
(11-746-52) GOUTTIÈRE DROITE E-1	2	2		(11-754-52) JOINTURE DE POUTRE J	2	3	
(11-747-52) GOUTTIÈRE GAUCHE E-2	2	2		(11-751-52) MI- POUTRE LATÉRALE L	2	2	
(11-758-52) PLAQUE DE GOUTTIÈRE F-1	3	2		(11-750-52) POUTRE LATÉRALE L-1	2	4	
(11-759-52) PLAQUE DE GOUTTIÈRE F-2	3	2		(11-761-52) PLAQUE LATÉRALE L-2	3	4	
(11-749-52) JOINTURE D'ARCHE H	3	6		(11-745-52) CHEVRON FINAL N	3	4 (emballé dans poteau)	

DESCRIPTION	EMBALLE DANS LA BOITE	QTÉ	DESSIN	DESCRIPTION	EMBALLE DANS LA BOITE	QTÉ	DESSIN
(11-744-52) CHEVRON PRINCIPAL O	3	12 (emballé dans poteau)		(11-769-52) ÉCROU BORGNE W	3	36 +3 spare	 M8
(11-767-52) PANNEAU DE TOIT P	1	14		(11-770-52) BOULON X	3	84 +3 spare	 M6x16mm
(11-768-52) BOULON M	3	40 +4 spare	 M6x16mm	(11-774-52) RONDELLE X-1	3	102 +4 spare	 1/4
(11-779-52) ÉCROU M-1	3	142 +5 spare	 M6	(14-044-52) BOULON X-2	3	18 +1 spare	 M6x22mm
(11-777-52) RONDELLE Q-1	3	72 +4 spare	 M8	(11-778-52) VIS Y	3	8 +1 spare	
(11-783-52) BOULON S	3	12 +1 spare	 M10*25mm	(11-765-52) CLÉ Z	3	1	
(11-784-52) RONDELLE S-1	3	24 +2 spare	 M10	(11-771-52) BOULON Aa	3	56 +3 spare	 M4x16mm
(11-785-52) ÉCROU BORGNE S-2	3	12 +1 spare	 M10	(11-772-52) ÉCROU Aa-1	3	56 +3 spare	 M4
(11-773-52) BOULON T	3	24 +1 spare	 M8*100mm	(11-776-52) RONDELLE FREIN Aa-2	3	56 +3 spare	 M4
(11-782-52) BOULON U	3	12 +1 spare	 M8*25mm	(11-775-52) RONDELLE V	3	12 +1 spare	 M8

ÉTAPE 01A:

(Pièces: **A** x6, **B** x12, **C** x6, **D** x6)

(Quincaillerie: **T** x24, **Q-1** x48, **W** x24 pour 6 poteaux total)

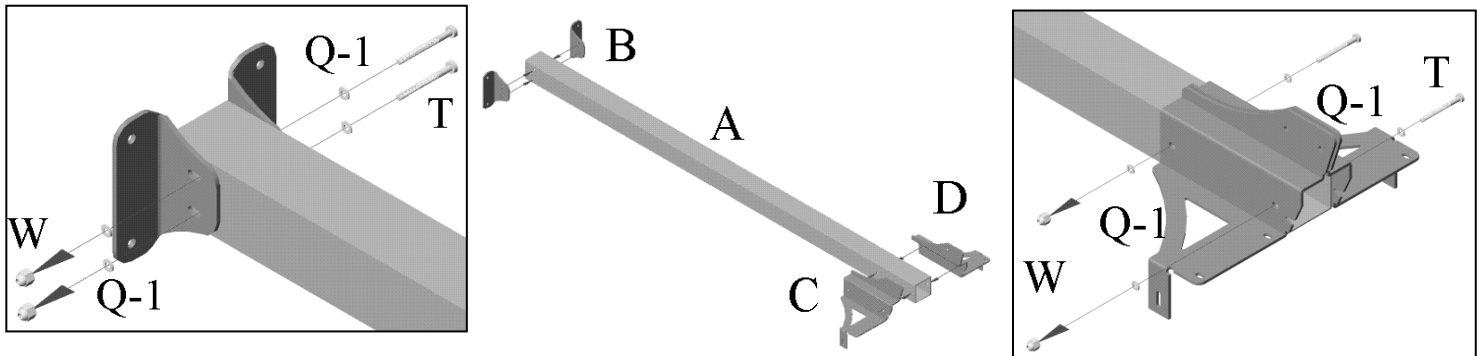

x6

ÉTAPE 01B:

(Pièces: **E** x2, **E-1** x2, **E-2** x2, **F-1** x2, **F-2** x2, silicone pour le scellage (non-inclus))

(Quincaillerie: **X** x24, **X-1** x24, **M-1** x24 pour 2 gouttières total)

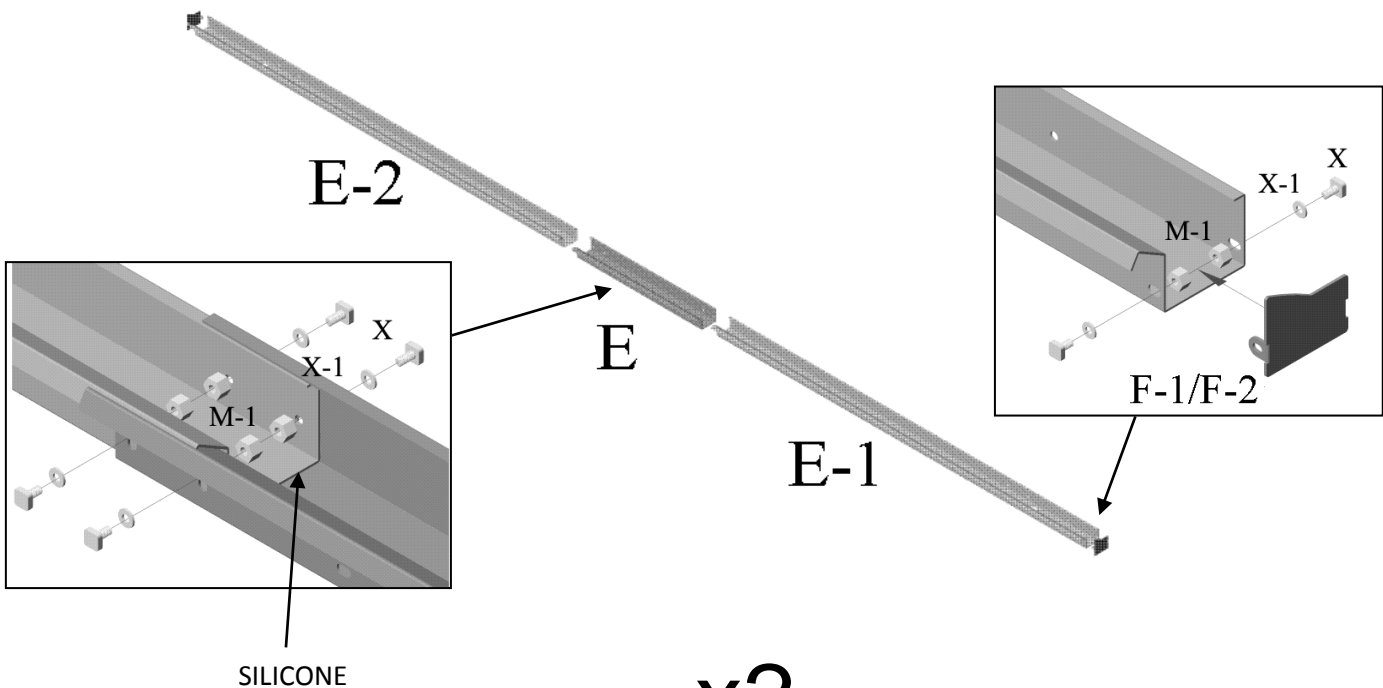

x2

ÉTAPE 01C:

(Pièces: **H** x6, **H-1** x3, **H-2** x3)

(Quincaillerie: **S** x12, **S-1** x24, **S-2** x12 pour 3 arches total)

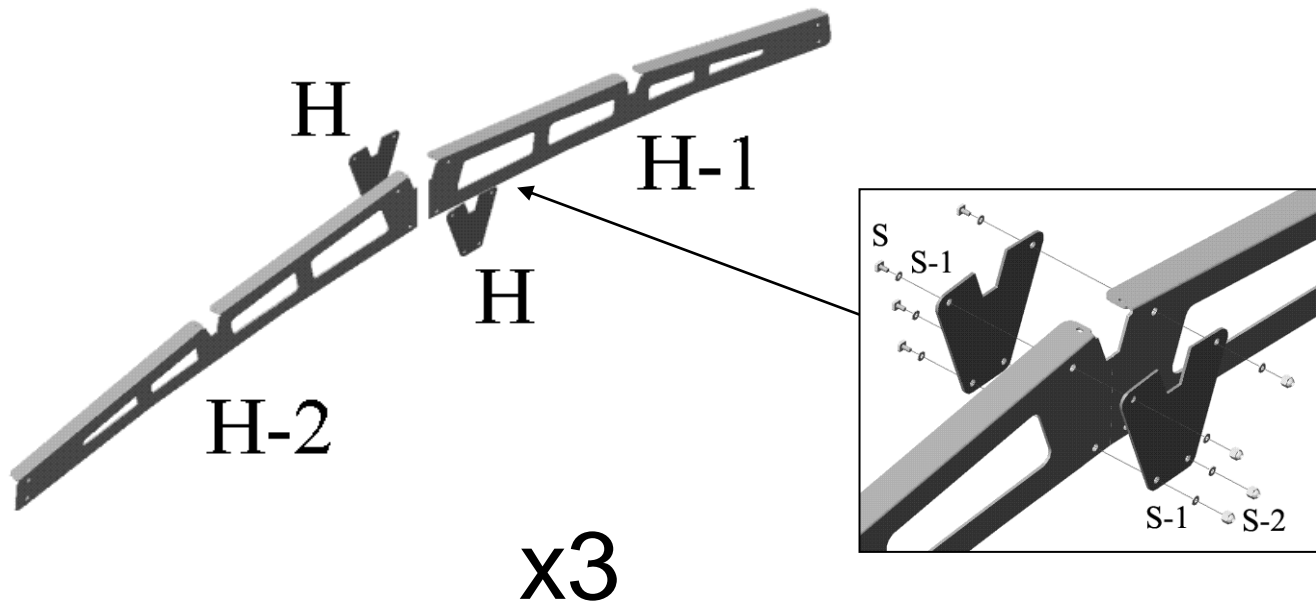

ÉTAPE 01D:

(Pièces: **I** x1, **I-1** x2, **I-2** x2, **J** x2)

(Quincaillerie: **X** x4, **X-1** x4, **M-1** x4 pour centre; **X** x8, **X-1** x8, **M-1** x8 pour bouts; **Y** x4 pour plaques)

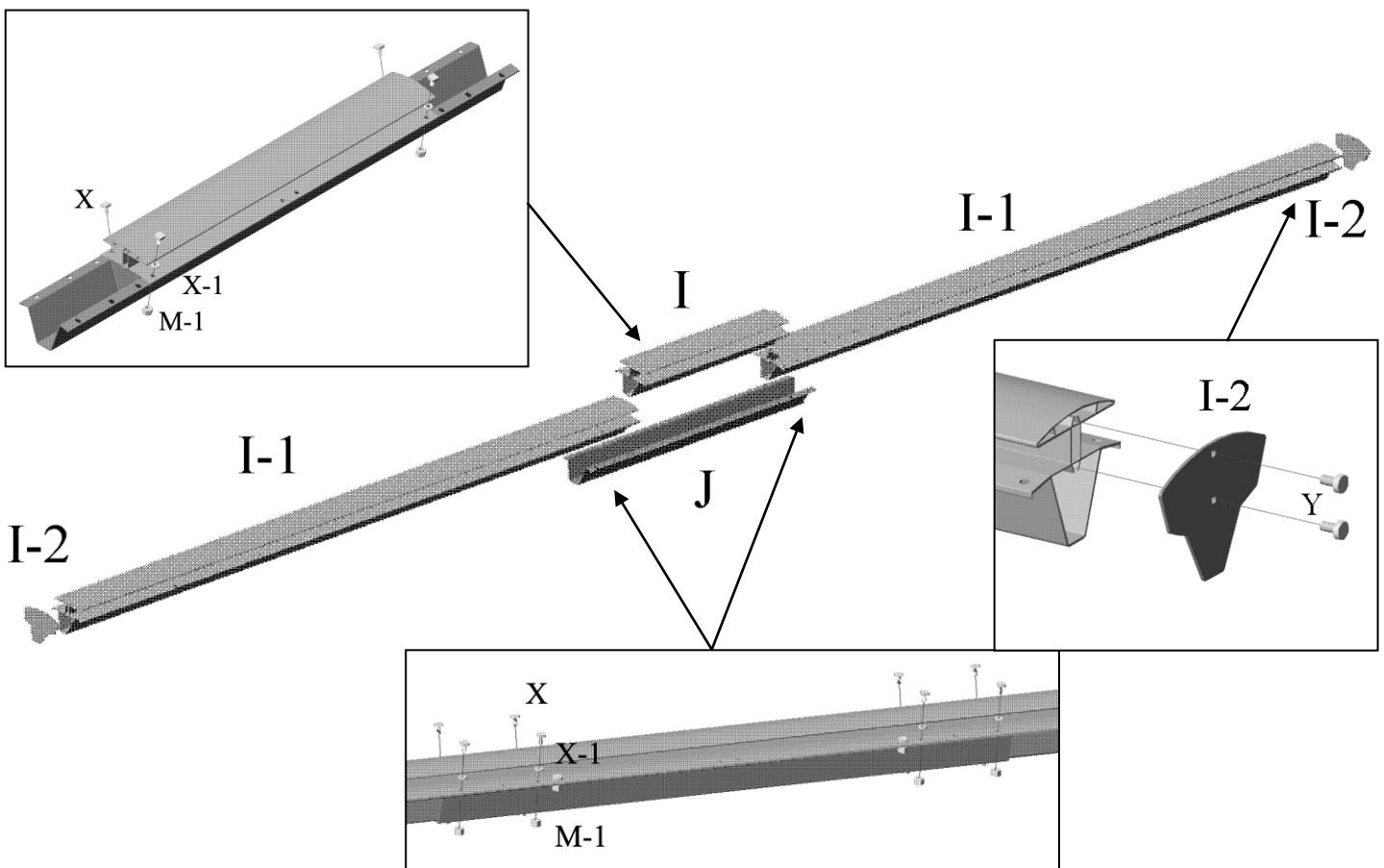

ÉTAPE 01E:

(Pièces: L x2, L-1 x4, L-2 x4, J x2)

(Quincaillerie par poutre: X x4, X-1 x4, M-1 x4 pour centre, X x8, X-1 x8, M-1 x8 pour bouts, Y x2 pour plaques; 2 poutres total)

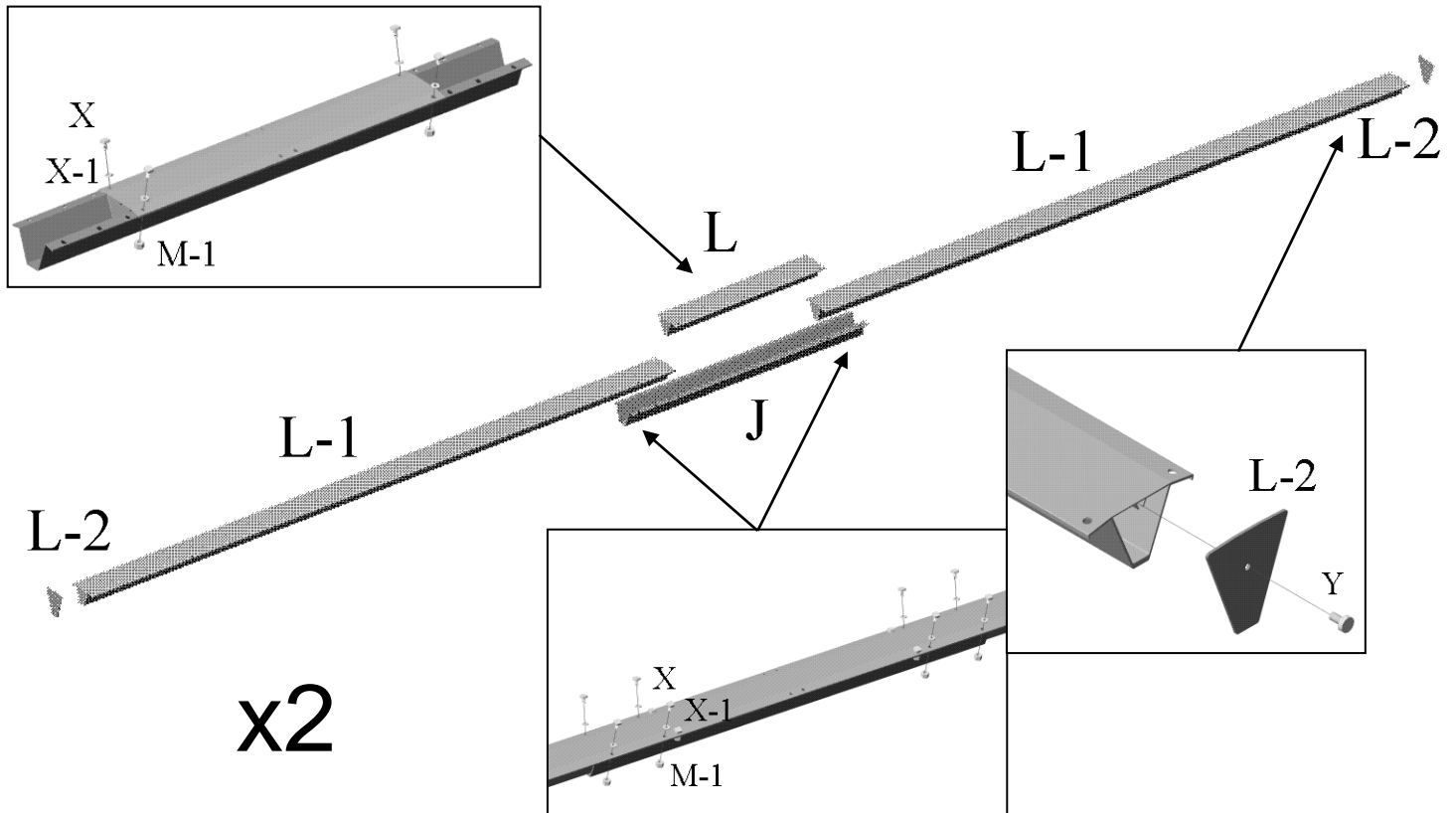

ÉTAPE 02:

(Quincaillerie: X-2 x4, X-1 x4, V x4, M-1 x4 pour les bouts; X-2 x2, X-1 x2, M-1 x2 pour centre)

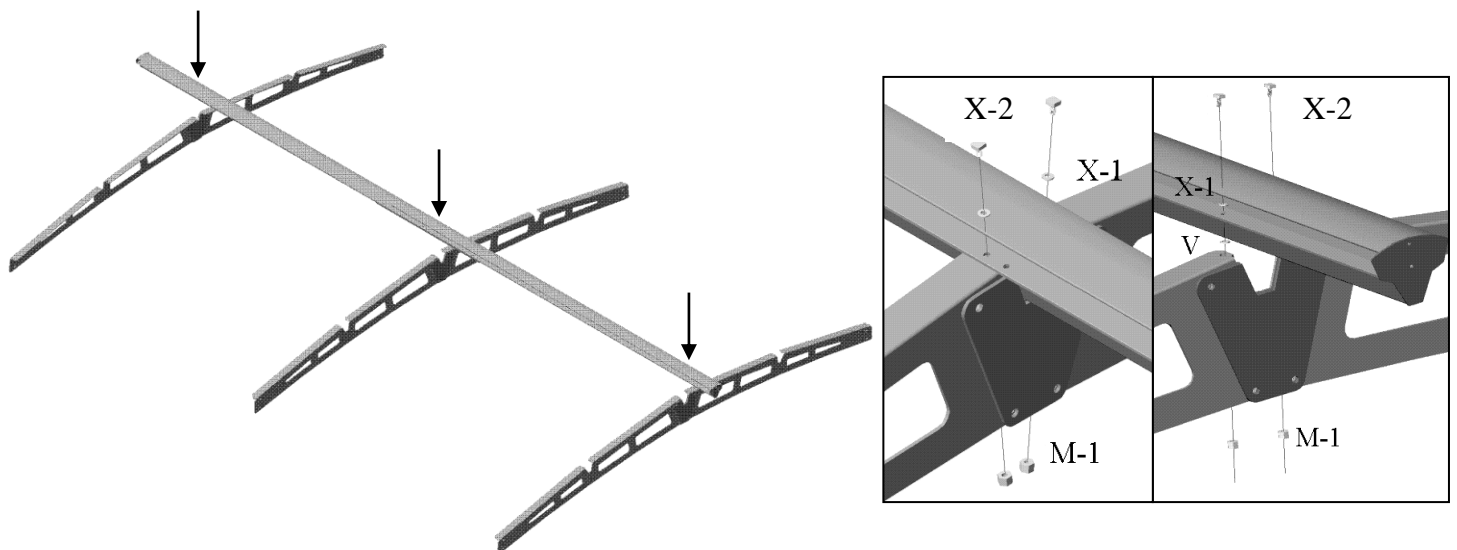

ÉTAPE 03:

(Quincaillerie: X-2 x12, X-1 x12, V x8, M-1 x12 pour 2 poutres total)

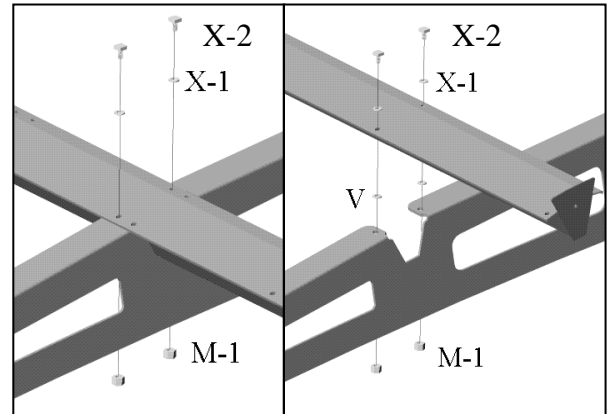
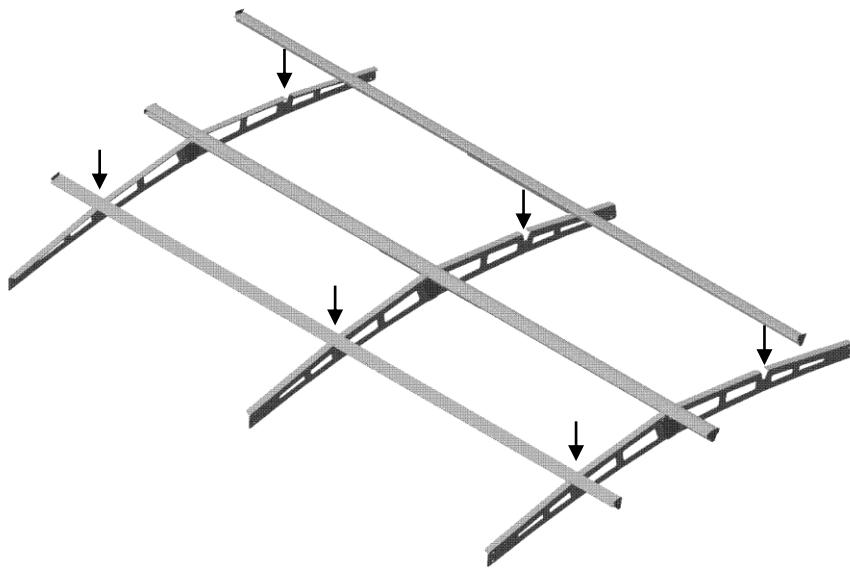

ÉTAPE 04:

(Quincaillerie: U x6, Q-1 x12, W x6 pour 3 arches total)

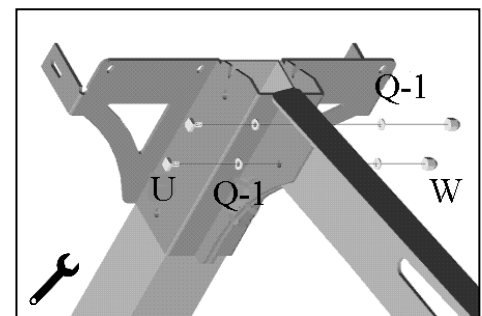
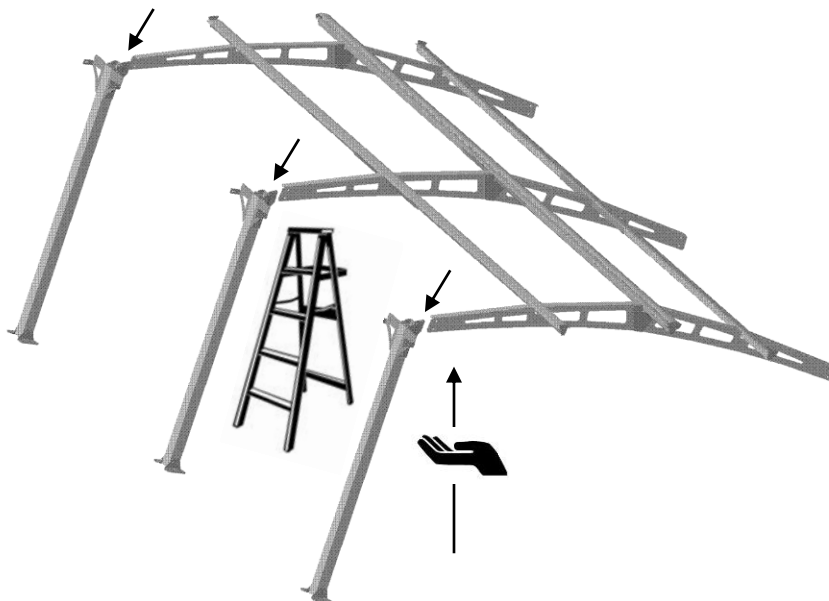

ÉTAPE 05:

(Quincaillerie: **X** x12, **X-1** x12, **M-1** x12)

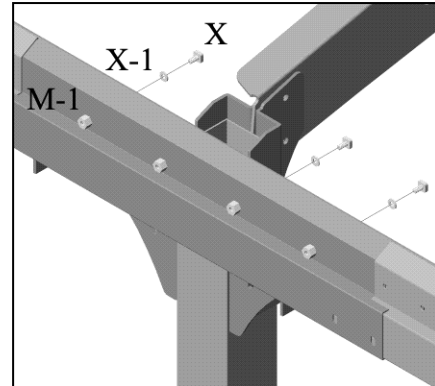

ÉTAPE 06:

(Quincaillerie: **U** x6, **Q-1** x12, **W** x6 pour 3 arches total)

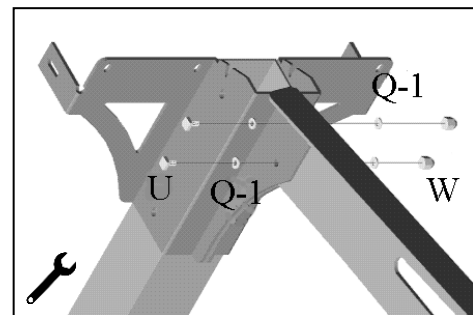
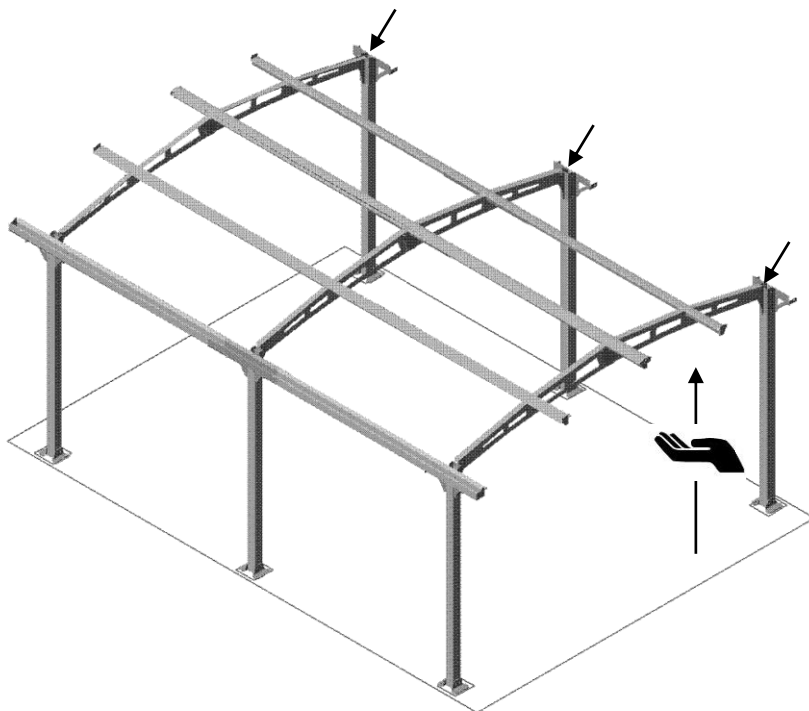

ÉTAPE 07:

(Quincaillerie: X x12, X-1 x12, M-1 x12)

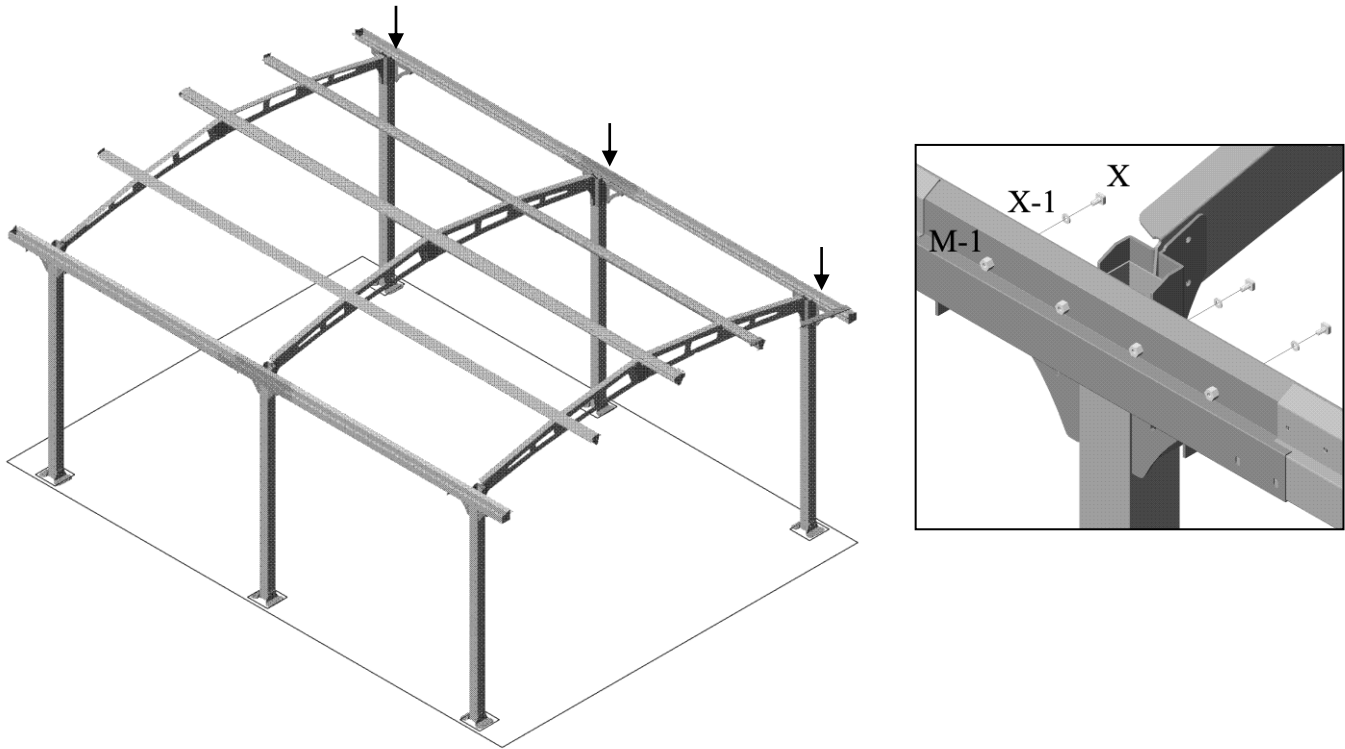

ÉTAPE 08:

(Quincaillerie: M x16, M-1 x16)

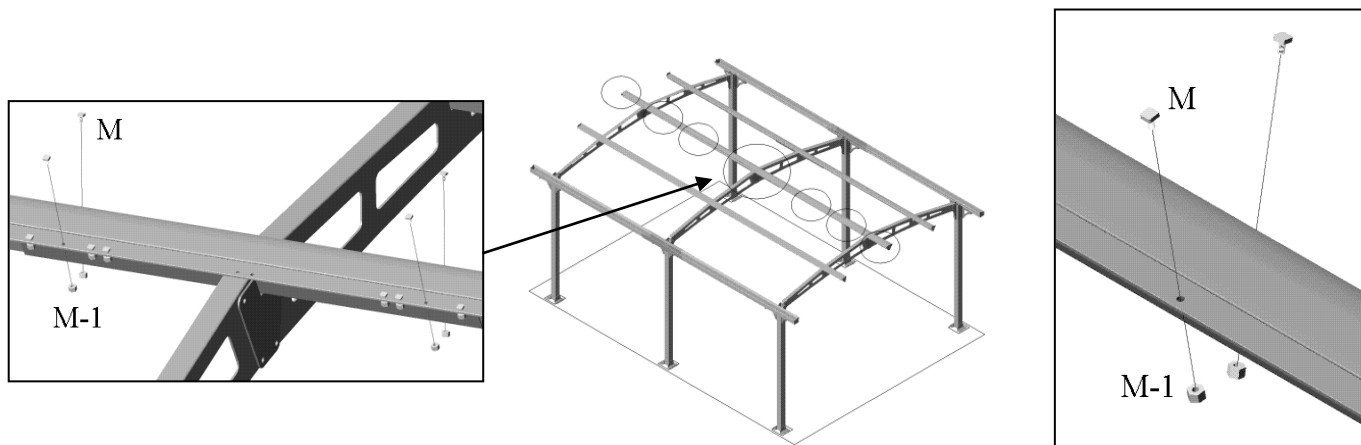

ÉTAPE 09:

(Pièces: **N** x4, **O** x12)

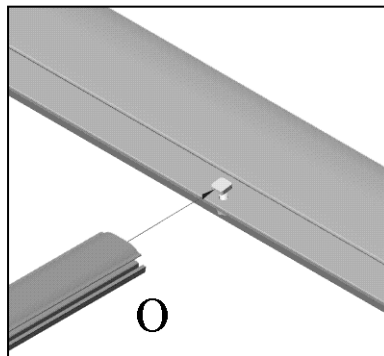
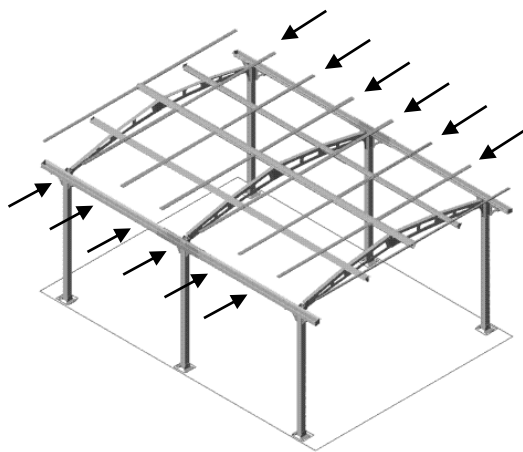
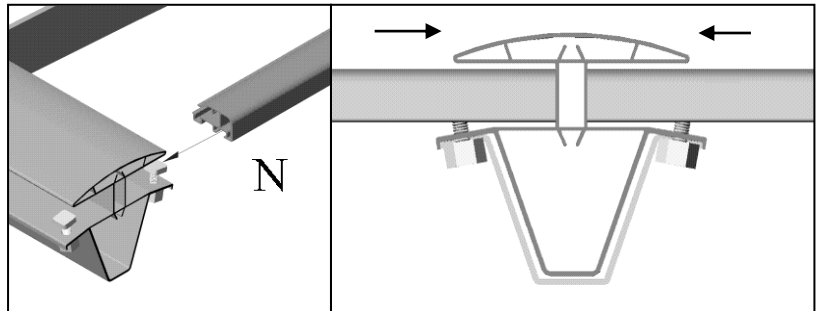
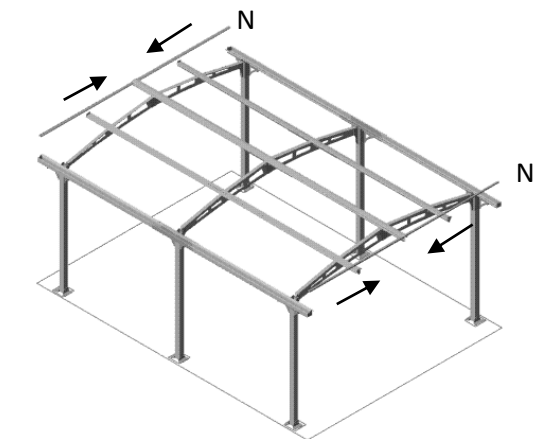

ÉTAPE 10:

À ce point, vérifiez que chaque poteau soit vertical et correctement positionné, et serrez tout les boulons qui ne l'ont pas été encore. 

ÉTAPE 11:

(Pièces: P x14)

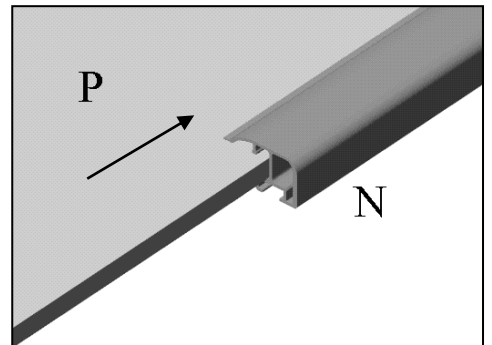
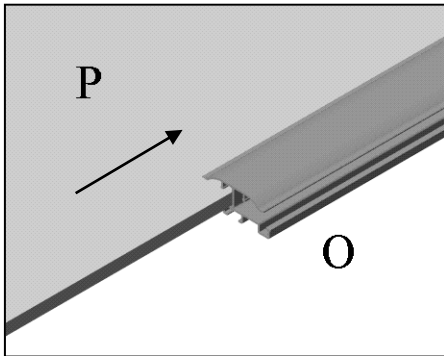
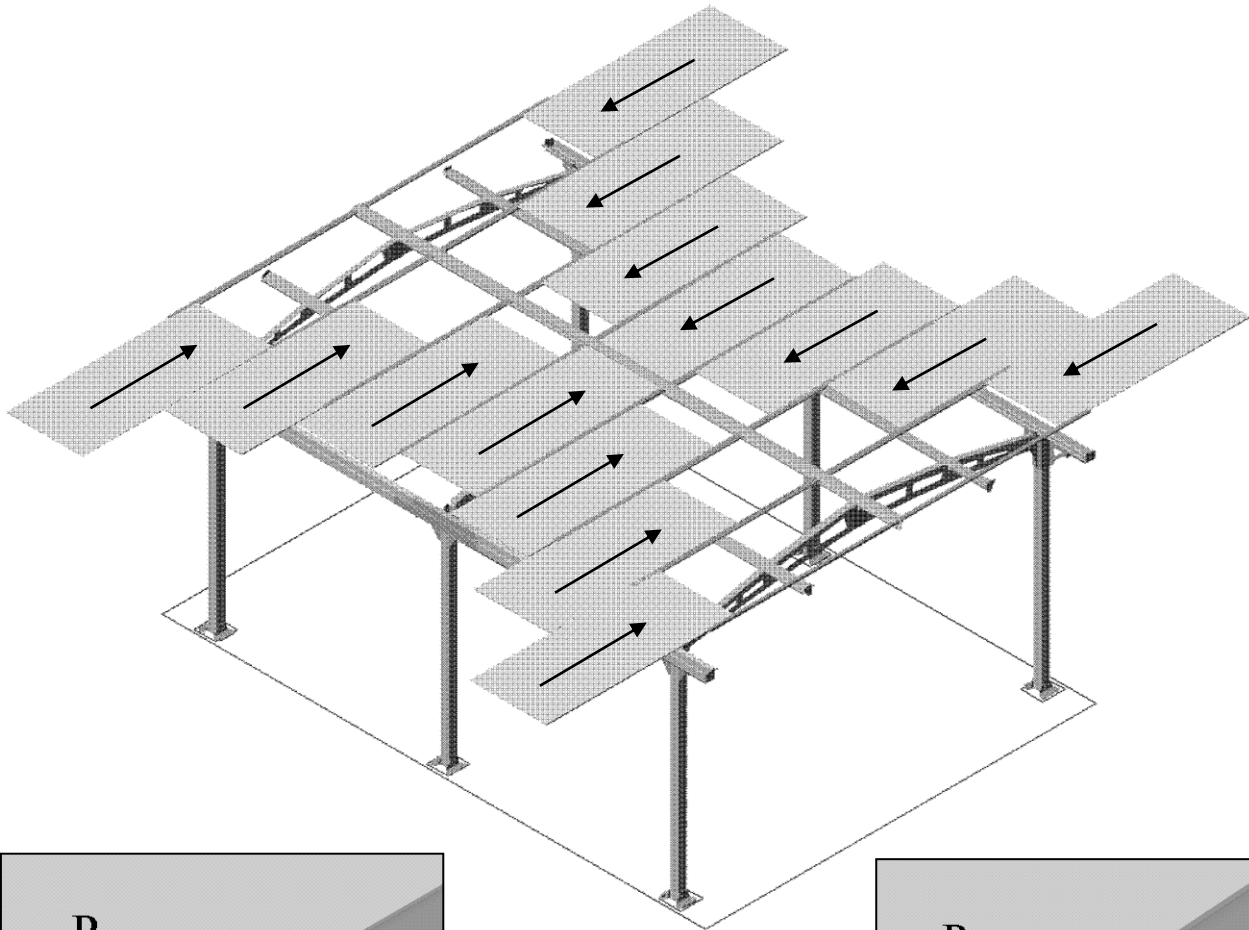

ÉTAPE 12:

(Quincaillerie: **M** x12 dans chevrons finals; **M** x12 dans chevrons principaux; **M-1** x24)

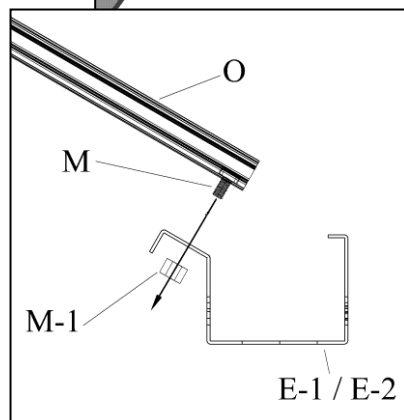
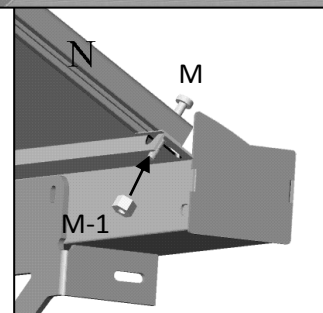
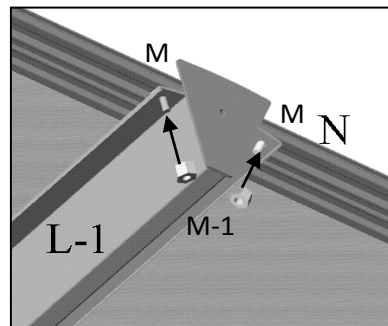
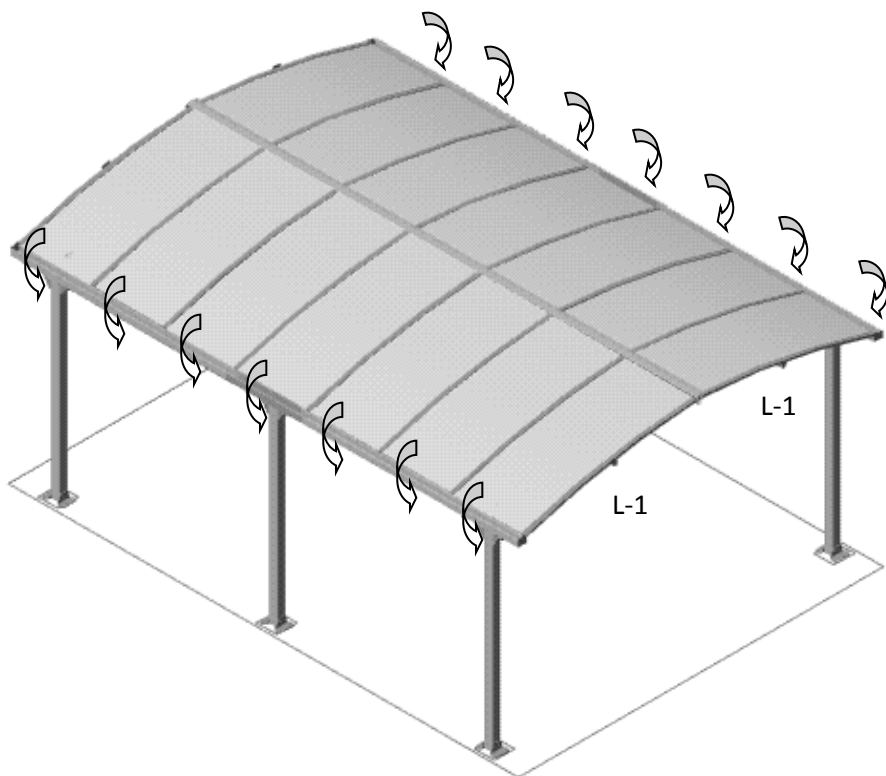

ÉTAPE 13:

Ancrez l'unité de façon appropriée à votre fondation. La quincaillerie et les outils pour l'ancrage ne sont pas inclus avec ce produit.

ÉTAPE 14:

(Quincaillerie: **Aa** x56; **Aa-1** x56; **Aa-2** x56 pour 14 panneaux total)

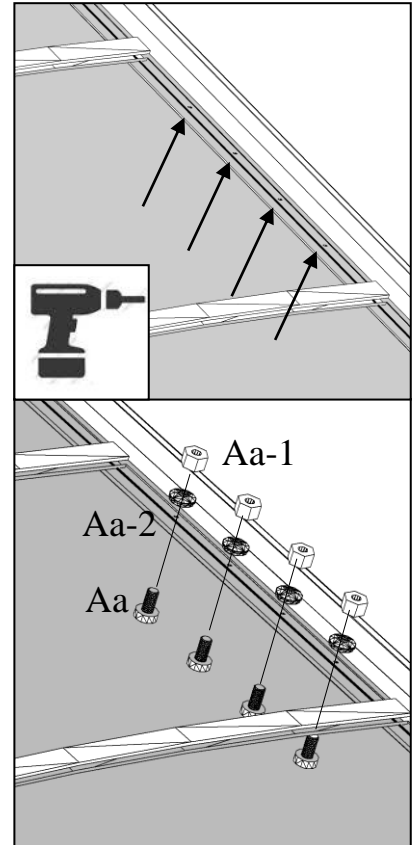
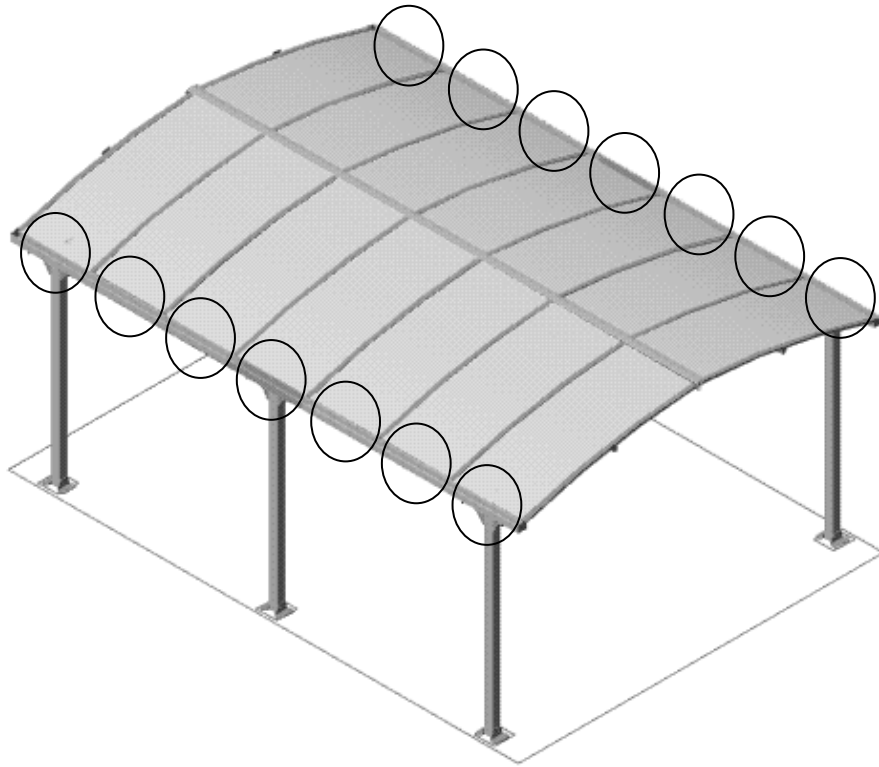

NOTES D'ENTRETIEN

1. En cas de pièces défectueuses ou endommagées, ou pour questions concernant le produit, veuillez contacter le manufacturier directement.
2. Ayez, s'il-vous-plait, le nom et numéro de pièce en main quand vous commandez des pièces de remplacement.
3. Ne placez pas l'abri en dessous d'un arbre ou la pente d'un toit de maison. La neige ou la glace pourra glisser et causer le gazebo de s'effondrer.
4. Bien que ce solarium soit conçu pour rester monté toute l'année, il est nécessaire de garder le toit libre de toute accumulation de neige.



GARANTIE LIMITÉE D'UN AN

Ce produit a été conçu et fabriqué afin de répondre aux normes les plus exigeantes en matière de qualité et de durabilité. Sous réserve des sections « conditions d'application de la garantie » et des « limitations à la garantie » ci-dessous, il est garanti contre les défauts matériels ou de fabrication et ce, pour une période d'**une année** de la date d'achat. Advenant que le produit soit endommagé ou que la période de garantie soit expirée, veuillez contacter le département de service à la clientèle de Gazebo Penguin afin d'obtenir une liste complète des pièces de remplacement et des prix applicables.

CONDITIONS D'APPLICATION DE LA GARANTIE

Afin d'assurer l'application de la garantie, veuillez vous conformer aux instructions suivantes :

Inspectez soigneusement le contenu de l'emballage afin de vérifier si certaines composantes sont manquantes ou endommagées. Advenant que certaines pièces soient manquantes ou endommagées, **ne retournez pas le produit à l'endroit où vous l'avez acheté**; contactez plutôt le département du service à la clientèle de Gazebo Penguin aux numéros ci-dessous (français/anglais, Lun-Ven 8:00 à 16:00 HNE): **Référence: SUN.150305**

Montréal : (514) 276-3485

Ailleurs au Canada et aux États-Unis : 1-800-737-7174

Vous pouvez aussi trouver un formulaire de réclamation en ligne :

<https://abrispenguin.com/assemblyinstructions/>

NOTE : Toutes pièces endommagées/manquantes devraient être signalées en dedans de 30 jours de la date de livraison, faute de quoi votre réclamation peut être rejetée.

LIMITATIONS À LA GARANTIE

1. Ce produit n'est pas garanti contre les dommages causés par le vandalisme, l'abus, ou les objets tombants ou lancés.
2. Ce produit n'est pas garanti contre les dommages causés par les conditions climatiques extrêmes, tels que les orages, la grêle, les tempêtes de vent ou de neige, ou autre actes de Dieu.
3. Ce produit est seulement garanti s'il a été installé en accord avec les instructions écrites incluses avec le produit.
4. Le produit n'est pas garanti s'il a été ancré incorrectement.
5. Nous nous réservons le droit de remplacer ou réparer tout produit ou pièce défectueux à notre seule discrétion.
6. Aucune modification au produit n'est autorisée. Cela annulera votre garantie.