

Atomic Projection Alarm Clock

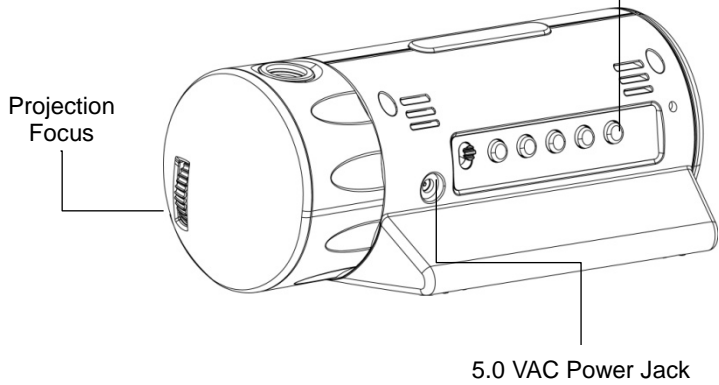

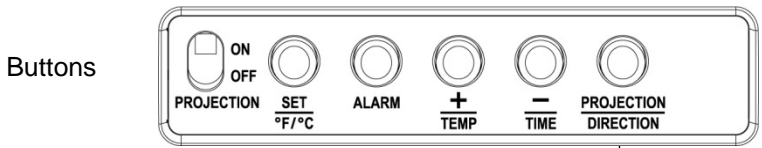
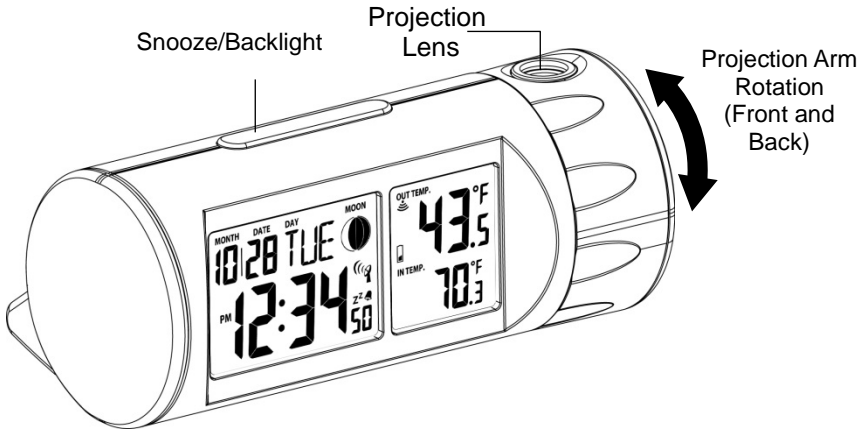
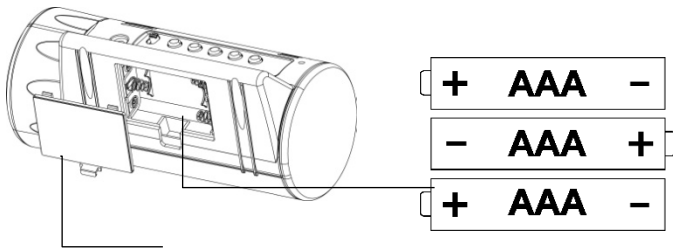

TX141-Bv2
Outdoor Sensor

Battery Cover

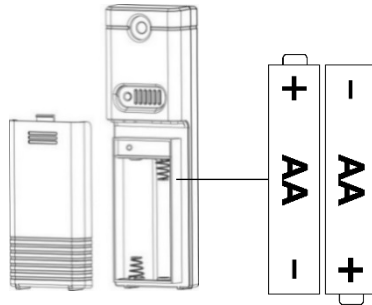

Get Started

1. Insert 2 new “AA” batteries (not included) into the TX141-BV2 sensor. Observe the correct polarity.
2. Insert the included 5-volt AC power adapter into projection alarm and then into wall outlet.
3. Optional: Insert 3 new “AAA” batteries (not included) into the projection alarm. Observe the correct polarity.
4. After 5 minutes, place the sensor outside in a shaded location. Maximum range is 300 feet (91 meters) open air.

Tip: If the outdoor temperature is not displayed after 3 minutes, Hold the **+/TEMP** button to search for the sensor. Press the TX button on the sensor to send a signal.

Set Time, Date, etc.

1. Hold the **SET/°F/°C** button to enter time set mode.
2. Use the **+/TEMP** or **-/TIME** buttons to adjust values. Press and hold for fast adjustment.
3. Press the **SET/°F/°C** button to confirm adjustments and move to the next item.

Time and Date setting order:

1. WWVB (ON/OFF)
2. Time Zone
3. DST Daylight Saving Time (ON/OFF)
4. 12/24 Hour Time Format
5. Hour
6. Minutes
7. Year
8. Month
9. Date

TIME ZONE	
AST	Atlantic
EST	Eastern
CST	Central
MST	Mountain
PST	Pacific
AKT	Alaska
HAT	Hawaiian

Press the **SET/°F/°C** button to exit, or wait 20 seconds without pressing buttons to return to the normal time display.

Fahrenheit/Celsius

Press the **SET/°F/°C** button to select Fahrenheit or Celsius temperature display.

Set Time Alarm

1. Hold the **ALARM** button to enter alarm time set mode.
2. Use the **+/TEMP** or **-/TIME** buttons to adjust values.
3. Press the **ALARM** button to confirm adjustments and move to the next item.

Alarm Time setting order:

1. Hours
2. Minutes

Activate/Deactivate Time Alarm

- Press the **ALARM** button once to view alarm time.
- Press the **ALARM** button again to activate the alarm.
Bell icon appears.
- Press the **ALARM** button again to deactivate the alarm.
The bell icon disappears.



Snooze

- Press the **SNOOZE/LIGHT** button to silence alarm for 10 minutes.
- **Zz** will show.
- When in snooze mode, press **ALARM** to stop alarm for one day.

Note: The alarm is crescendo sound. The alarm will sound for 2 minutes and then shut off completely.

Backlight

- Press the **SNOOZE/LIGHT** button to activate the backlight for 5 seconds. The backlight will not remain on constantly.

Moon Phase

The segments that are highlighted will portray the part of the moon that is lit. For instance, the moon will be blank during a new moon and dark during a full moon. This is how this product is designed to best view the moon on the display, what you will see in the sky. This cannot be changed.



Atomic Time Signal Search

- Press the **-/TIME** button to start or stop a manual signal search. WWVB Icon will flash

For information about WWVB visit:
www.nist.gov/pml/div688/grp40/wwvb.cfm



Projection (On/Off, rotate, focus)

- **Projection ON/OFF button:** Slide to turn the projection off or on when operating on AC power.
- **Projection Direction button:** Press to rotate projection 180°.
- **Focus Wheel:** Use the Focus wheel to focus the projected image.

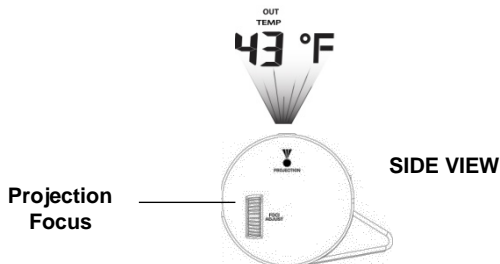

Time/Outdoor Temperature Projection: The projection will alternate between time and outdoor temperature every 5 seconds. **This is not adjustable.**

Note:

- On AC power the projection will be on constantly and alternate between time and outdoor temperature (unless turned to OFF).
- Using battery power, the projection and backlight will come on for 10 seconds when **SNOOZE/LIGHT** is pressed.

Position Outdoor Sensor

- Mount the outdoor sensor on a North-facing wall or in any well shaded area. Under an eave or deck rail is preferred.
- The maximum transmitting range to the atomic projection alarm is over 300-feet (91 meters) in open air, not including walls.

Search for Outdoor Sensor

- Hold the **+/TEMP** button for 3 seconds to search for the outdoor sensor .



Position Projection Alarm

- The projection alarm has a wide base to sit on a desk or table.
- Choose a location 6 feet or more from electronics such as cordless phones, wireless gaming systems, televisions, microwaves, routers, baby monitors, etc., which can prevent signal reception.
- Position near an exterior wall that faces Ft. Collins Colorado for WWVB time signal reception.
- Place within 300 ft. (91 meters) of the outdoor sensor.
- Obstacles such as walls, windows, stucco, concrete and large metal objects can reduce the range.
- Be aware of electrical wires and plumbing within a wall. This will interfere with RF (radio frequency) signal reception.

Low Battery Icon

When the low battery icon is displayed it warns to replace batteries.

- If the icon is displayed in Outdoor Temperature section, replace batteries in the outdoor sensor.

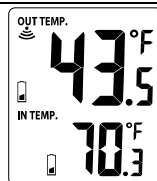

- If the icon is displayed in Indoor Temperature section, replace batteries in the projection alarm.

Specifications	
Indoor:	
Temperature Range:	32°F to 122°F (0°C to 50°C)
Interval:	About every 30 seconds
Outdoor:	
Temperature Range:	-40°F to 140°F (-40°C to 60°C)
Alkaline Batteries:	-20°F to 140°F (-28.8°C to 60°C)
Lithium Batteries:	-40°F to 140°F (-40°C to 60°C)
Distance:	Over 300 ft. (91 meters) RF 433MHz (open air)
Interval:	About every 30 seconds
Power:	
Projection Alarm	
Primary Power: AC6: GPU280500150WA00	5-volt AC power adapter (included)
Optional/Battery Backup	Optional 3-AAA, IEC, LR3 batteries (not included)
TX141-Bv2 Sensor :	2-AA, IEC, LR6 batteries (not included)
Battery Life:	
Projection Alarm Battery Backup:	Battery life is over 12 months when using the AC adapter for primary power
TX141-Bv2 Sensor :	Battery life is over 24 months when using reputable battery brands for both Alkaline and Lithium batteries
Dimensions:	
Projection Alarm:	7.09" x 3.62" x 2.87" (180 x 92 x 73mm)
TX141-Bv2 Sensor :	1.57" x 0.79" x 5.12" (40 x 20 x 130mm)

Care and Maintenance

- Do not mix old and new batteries
- Do not mix Alkaline, Standard, Lithium, or Rechargeable Batteries
- Always purchase the correct size and grade of battery suitable for the intended use.
- Replace all batteries of a set at the same time.
- Clean the battery contacts and also those of the device prior to battery installation.
- Ensure the batteries are installed correctly in regard to polarity (+/-).
- Remove batteries from equipment when it is not to be used for an extended period.
- Promptly remove expired batteries.
- If the product is not working properly, change the batteries and/or check the A/C cord connection.

Warranty and Support

La Crosse Technology, Ltd. provides a 1-year limited time warranty (from date of purchase) on this product relating to manufacturing defects in materials & workmanship.

Before returning a product, please contact our friendly customer support with questions or visit our online help:

Phone: 1-608-782-1610

Online Product Support and Registration:

www.lacrossetechnology.com/support

FCC Statement

This equipment has been tested and found to comply with the limits for a Class B digital device, pursuant to part 15 of the FCC Rules. These limits are designed to provide reasonable protection against harmful interference in a residential installation. This equipment generates, uses and can radiate radio frequency energy and, if not installed and used in accordance with the instructions, may cause harmful interference to radio communications. However, there is no guarantee that interference will not occur in a particular installation. If this equipment does cause

harmful interference to radio or television reception, which can be determined by turning the equipment off and on, the user is encouraged to try to correct the interference by one or more of the following measures:

- Reorient or relocate the receiving antenna.
- Increase the separation between the equipment and receiver.
- Connect the equipment into an outlet on a circuit different from that to which the receiver is connected.
- Consult the dealer or an experienced radio/TV technician for help.

This device must not be co-located or operating in conjunction with any other antenna or transmitter.

Operation is subject to the following two conditions:

- (1) This device may not cause harmful interference, and
- (2) This device must accept any interference received, including interference that may cause undesired operation.

Caution!

The manufacturer is not responsible for any radio or TV interference caused by unauthorized modifications to this equipment. Such modifications could void the user authority to operate the equipment.

All rights reserved. This manual may not be reproduced in any form, even in part, or duplicated or processed using electronic, mechanical or chemical process without the written permission of the publisher. This booklet may contain errors or misprints. The information it contains is regularly checked and corrections are included in subsequent editions. We disclaim any responsibility for any technical error or printing error, or their consequences.

All trademarks and patents are recognized.