



**ABYSS
BATTERY**

POWER YOUR PURSUIT.

**DEEP-DROP / KITE ELECTRIC
FISHING REEL BATTERY**

PAB-5000 / PAB-9000



USER MANUAL

WWW.ABYSSBATTERY.COM



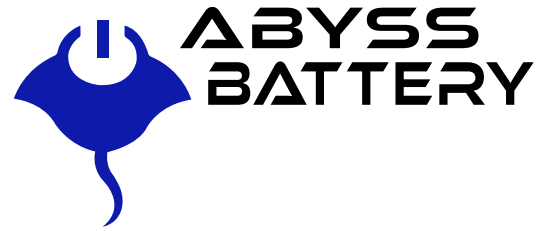
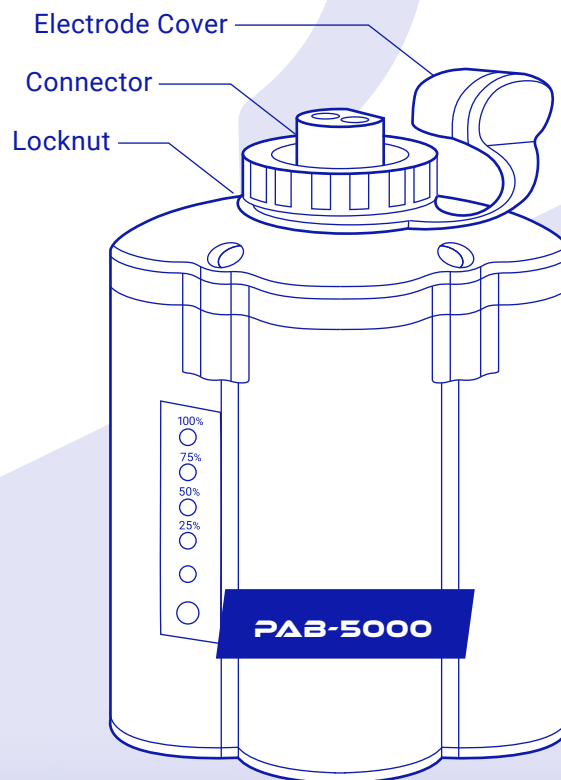
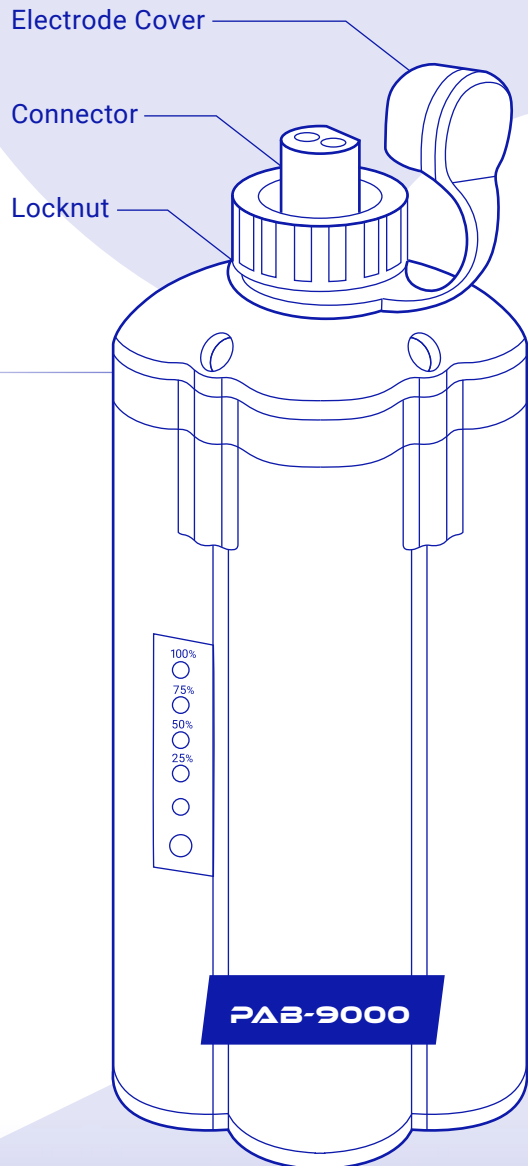

TABLE OF CONTENTS

PRODUCT OVERVIEW.....	01
PACKAGE INCLUDES.....	02
TECHNICAL SPECIFICATIONS.....	02
INTRODUCTION.....	03
FEATURES.....	03
OPERATION METHOD.....	04
STORAGE & MAINTENANCE.....	06
SAFETY INSTRUCTIONS.....	06
WARNINGS.....	07
TROUBLESHOOTING.....	07
WARRANTY.....	08
DISPOSAL AND RECYCLING.....	09

PRODUCT OVERVIEW:



SPECIAL CHARGER

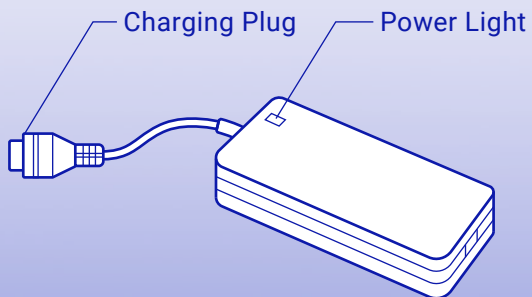

CABLE

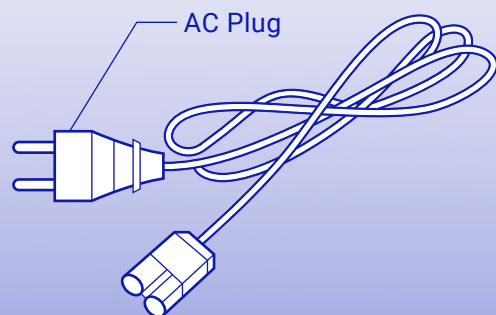

PACKAGE INCLUDES:

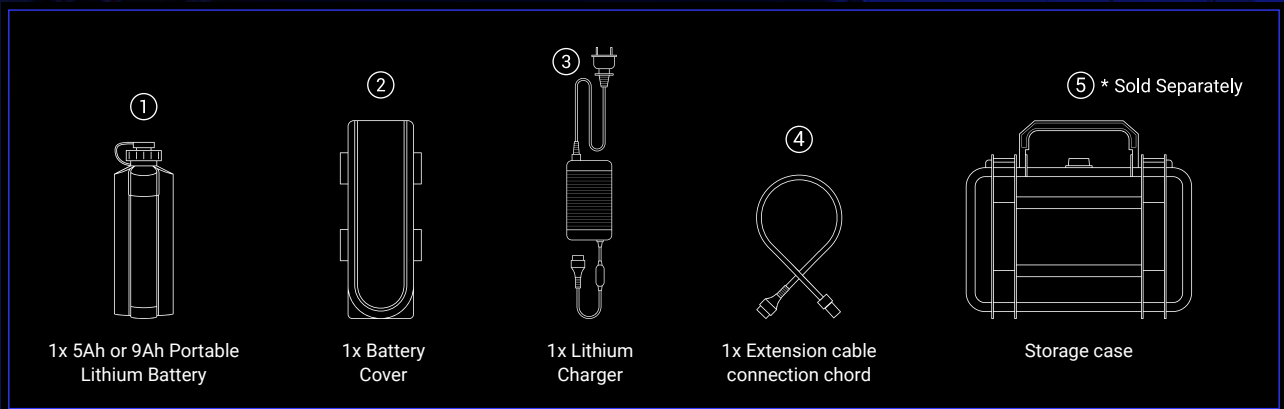

TECHNICAL SPECIFICATIONS:

PORTABLE BATTERY PAB-5000	VOLTAGE	Voltage: DC 14.8V	<input type="radio"/>
	CAPACITY TIME	Capacity: (5000±200) mAh (0.2C 25°C)	<input type="radio"/>
	DIMENSION	50mm(length) × 50mm(width) × 120 mm(height)	<input type="radio"/>
	WEIGHT	About: .8 lbs (365g)	<input type="radio"/>
PORTABLE BATTERY PAB-9000	VOLTAGE	Voltage: DC 14.8V	<input type="radio"/>
	CAPACITY TIME	Capacity: (9000±200) mAh (0.2C 25°C)	<input type="radio"/>
	DIMENSION	51mm(length) × 51mm(width) × 192 mm(height)	<input type="radio"/>
	WEIGHT	About: 1.6 lbs (730g)	<input type="radio"/>
CHARGER (OPTIONAL ACCESSORY: BATTERY SLEEVE, 0.45-METER CABLE, BATTERY DETECTOR)	INPUT PARAMETER	AC100-240V 50/60HZ	<input type="radio"/>
	OUTPUT PARAMETER	DC16.8V 4A (3A)	<input type="radio"/>
	CHARGING TIME	About 2.7 hours (about 3.6 hours)	<input type="radio"/>
	RED LIGHT ON	Charging	<input type="radio"/>
	GREEN LIGHT ON	Full charge	<input type="radio"/>
CHARGING t°C	0°C - 45°C	<input type="radio"/>	

FISHING REEL COMPATIBILITY



INTRODUCTION:

The revolutionary new Abyss Battery® Deep-Drop and Kite Reel Batteries are portable lithium batteries that plug directly into your electric fishing reel. These batteries seamlessly integrate with any electric reel, eliminating the hassle of excessive wires, and create a streamlined setup on your boat deck. With this portable and powerful battery, you can focus on reeling in your next big catch!!

Our fishing reel batteries are constructed with the same Grade-A UL certified LiFePO4 cells we use to build our marine batteries and enclosed in a waterproof sealed ABS plastic casing. 24 karat gold plated corrosion resistance connection terminals are used to achieve maximum conductivity from exposure to harsh marine environments and salt spray.



FEATURES:

1. The battery shell is made of high-strength, high-toughness, and impact-resistant ABS material (class VO).
2. The battery protection system has overcharge, over-discharge, overcurrent, short circuit, temperature protection, Undervoltage lockout load, and charge balance function, which can extend battery life.
3. When the electric wheel is overloaded, the safety protection function of the battery will be activated, and the power supply will be temporarily stopped. If the battery is disconnected and reconnected, it will automatically recover.
4. Under normal use, when the battery is recharged 500 times, the discharge capacity is $\geq 80\%$ of the initial capacity.
5. Battery life: Under normal use, after more than 1,000 cycles of charging and discharging, the battery may not be able to charge or the power will be greatly reduced, then please replace it with a new battery.
6. It's recommended that the battery should only be 50% during transportation.

OPERATION METHOD:

CHARGING:

The charging capacity is about 50% when you receive it, so please fully charge before use. To charge the battery (when using the PAB9000 or PAB5000 charger) follow the steps below:

1. **Align the electrode notch of the battery connector with the electrode notch of the charger plug, insert it to the bottom, and tighten the locknut.**
2. **Plug the charger power cord into the charger.**
3. **Insert the charger power cord plug into the AC100~220V socket, the charger indicator turns red, and charging starts.**
4. **Be sure to follow the above steps to charge the battery.**

POWER LIGHT	IMPLICATION
RED LIGHT ON	CHARGING
GREEN LIGHT ON	FULLY CHARGED
RED LIGHT FLASHING	ABNORMAL CHARGING

Don't charge in a place with combustible materials around.

- According to the remaining capacity of the battery before charging, the charging time will vary.
- When you find an abnormality, please contact Abyss Battery® at (855)-719-1727.

5. **After the battery is fully charged, please unplug the charger power cord in time.**
6. **Disconnect the battery from the charger.**
7. **Fasten the electrode protection cover.**



INSTALLATION:

INSTALLATION:

Method of connecting the battery and electric reel.

METHOD 1:

The battery is directly connected to the electric reel.

METHOD 2:

Using the velcro straps, attach the battery to the fishing rod, then connect the power cord.

ABOVE TWO METHODS:

Tighten the lock-nut to fix as shown in the image below.

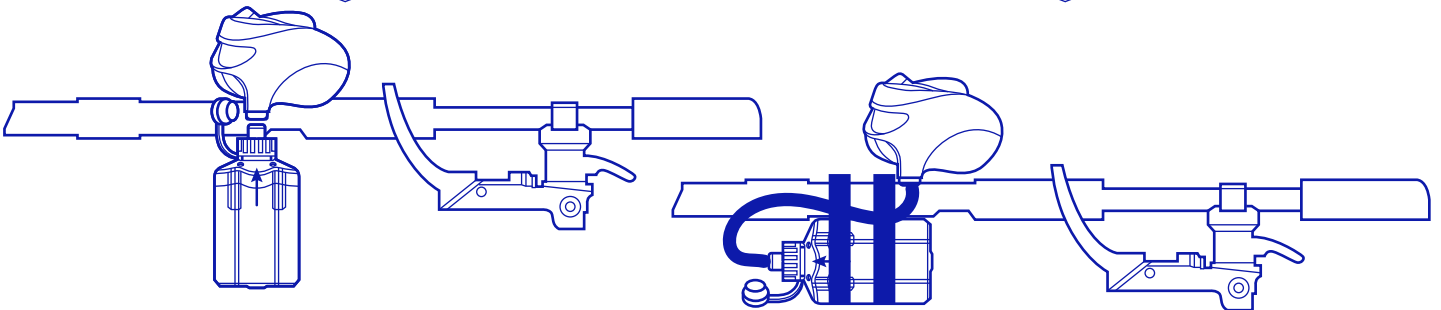

- Do not rotate the battery.
- The position of the battery and the pole stand:
- The battery must not interfere with the fishing rod and the boat's edge.

After using the battery, please fasten the electrode protection cover, if there is any moisture, please dry it before buckling and storing the battery.

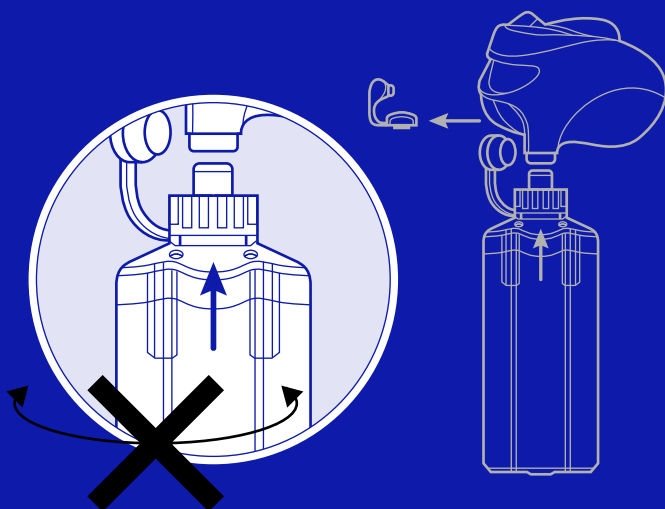

“ ATTENTION:

DO NOT leave the battery connected while underway.

DO NOT put too much pressure on the battery.

DO NOT operate beyond intended specifications.

STORAGE & MAINTENANCE:

If you plan on storing the battery for a long period of time, please keep it at a temperature of at $-20^{\circ}\text{C} \sim 25^{\circ}\text{C}$ dry and in a corrosive-free environment.

- Since the battery will self-discharge during storage, please charge it once every 6 months when it is stored for a long time or not in use.
- When the battery is installed on the electric reel, the connecting part of the battery and the electric reel cannot be forced.
- The electrode protection cover is not completely waterproof. Please do not immerse the electrode part in water.
- Please do not use organic solvents such as gasoline. If there is abnormal heating, peculiar smell, smoke, and other abnormalities occur during use, charging, or storage, please stop using it immediately and contact Abyss Battery.
- Please wipe the dirt off the battery (except the electrode part) with a clean towel dampened with clean water.
- When cleaning the electrode, please be careful not to damage the protective film of the electrode surface.

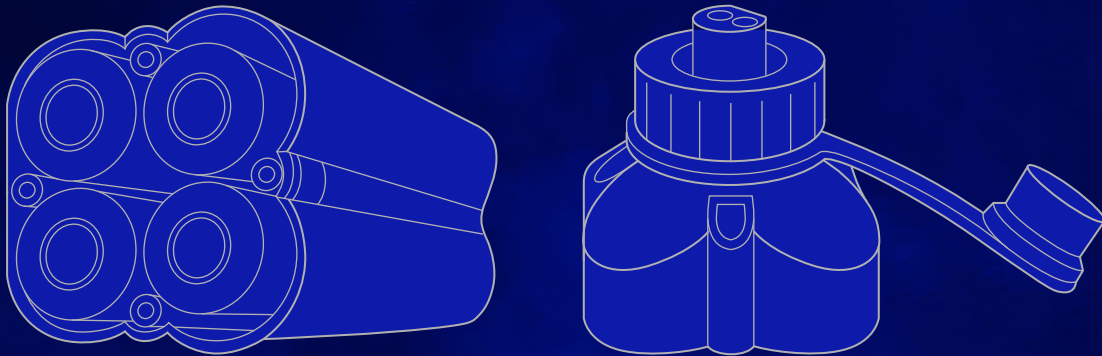

SAFETY INSTRUCTIONS:

To use safely and avoid hazards, please follow the instructions and warning labels.

Charger Safety Instructions:

- Don't break, heat, decompose or modify the charger.
- Please use AC100~220V 50Hz/60Hz socket.
- Please keep the room temperature at $0^{\circ}\text{C} \sim 45^{\circ}\text{C}$. Unplug the power plug from the socket when not charging.
- Don't break, heat, decompose or modify the battery.

WARNINGS:

Don't use the battery in a hot, hyperbaric, or sealed environment. Don't put the battery in fire or water.

- Don't break, heat, decompose or modify the battery.
- Please avoid direct sunlight and do not put the battery in the car.
- When using the battery, please keep the temperature at - 20°C ~ 60°C.
- Please use the designated charger and comply with the charging manual.
- Don't apply for other items except for the electric reel. It's specifically designed for fishing reels.
- Please avoid the battery from impacting strongly or dropping from heights.
- Cell damage, liquid flow, please take precautions. If the battery fluid contaminates the skin, please immediately wash with water. If it results in cystitis, please go to the hospital immediately.

TROUBLESHOOTING:

PROBLEM	FAULT AND POSSIBLE SOLUTIONS
BATTERY HEAT	<p>Charging and discharging heat is normal.</p> <p>If the battery is too hot to touch, the battery may be abnormal. Stop using it immediately and check at the dealer.</p>
THE ELECTRIC REEL DOES NOT WORK, OR THE WORKING TIME BECOMES SHORTER	<p>Battery exhausted, please charge.</p> <p>Please confirm whether there is any other matter in the electrode contact point.</p> <p>The battery protection function is activated, please disconnect the battery 5 seconds before reconnecting. (In the case of high-temperature protection, it takes about 15 minutes to restart Temperature at 25°C).</p> <p>The battery has a service life. If the discharge time is significantly lower after normal charging, please replace it with a new battery.</p>
BATTERY CAN'T BE CHARGED	<p>Please confirm whether [battery and charger] [charger and power cord] [power cord and plug] are connected correctly.</p> <p>Charging temperature protection (Charging temperature is between 0°C -45°C, it may not be able to charge if it exceeds this range.)</p>

WARRANTY:

CHARGING:

Thank you for taking interest in the products we offer at Abyss Battery. This Limited Warranty applies to physical goods, and only physical goods purchased from Abyss Battery. Unlike other Lithium battery companies, Abyss Battery has additional support through the purchase of our Extended Warranty program.

MANUFACTURER'S LIMITED WARRANTY

WARRANTY COVERAGE	2-YEAR FREE REPLACEMENT	AFTER 3 YEARS, 35% OFF A NEW REPLACEMENT UP TO 10-YEARS
-------------------	-------------------------	---



WHAT DOES LIMITED WARRANTY COVER?

- We guarantee that every battery sold by us or any of our authorized dealers and OEM distributors is defect-free from the date of purchase.
- Our Li-ion batteries are designed to be a drop-in replacement for lead-acid and AGM battery applications.
- This Limited Warranty covers any defects in materials and workmanship under normal use during the Warranty Period.
- During the Warranty Period, Abyss Battery will repair or replace, at no charge, products or parts of a product that proves defective because of improper workmanship, under normal use and maintenance.

THIS LIMITED WARRANTY DOES NOT COVER ANY PROBLEM THAT IS CAUSED BY:

- Conditions, malfunctions, or damage not resulting from defects in material or workmanship.
- Damages from shipping.
- Loose terminal bolts.
- Corroded hardware.
- Failure to improperly install the battery.
- Tampering or removal of manufacturer codes.
- Properly charging and maintaining the battery.
- Breakage from a collision.
- Improper storage, which includes damage from water, extreme heat, or freezing temperatures.
- All bolts must be tightened with a torque wrench and NOT by hand to avoid overheating caused by a loose connection.
- Use approved and authorized chargers only.



DISPOSAL AND RECYCLING:

- Lithium-Ion batteries are subject to disposal and recycling regulations that vary by country and region. Always check and follow your applicable regulations before disposing of any battery.
- Contact Rechargeable Battery Recycling Corporation (www.rbrc.org) for the U.S.A. and Canada, or your local battery recycling organization.
- Many countries prohibit the disposal of waste electronic equipment in standard waste receptacles.
- Place only discharged batteries in a battery collection container. Use electrical tape or other approved covering over the battery connection points to prevent short circuits.



Abyss Battery®

Tel: 1+(727)-306-2059

E-mail: Info@abyssbattery.com

Address: 1920 W Bay Dr, Largo, FL 33770



WWW.ABYSSBATTERY.COM