

2 x
AA

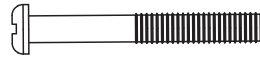

2 x
BB



4 x
CC

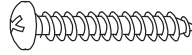

2 x
DD

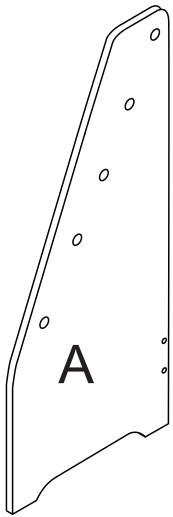

A

(R & L)

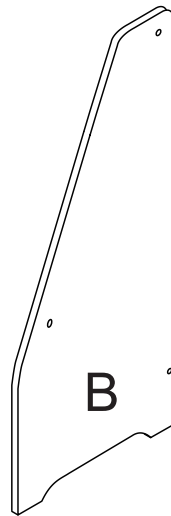

B

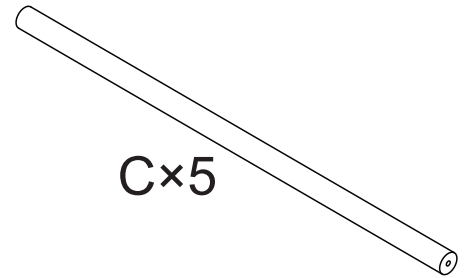

C x 5

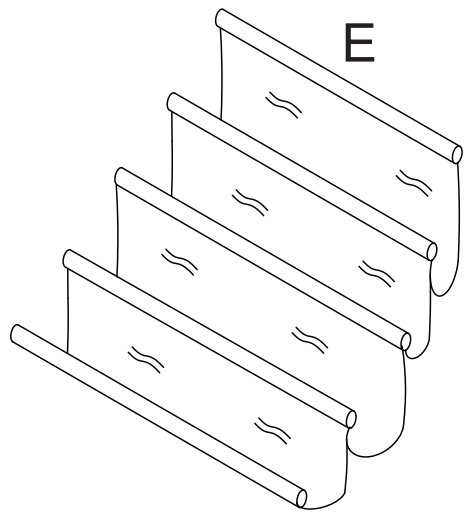

E

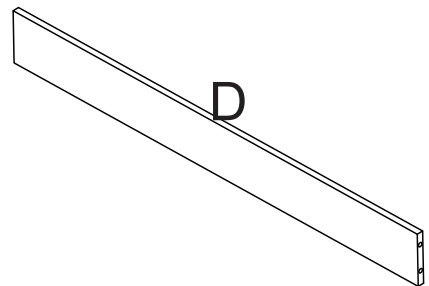

D

