

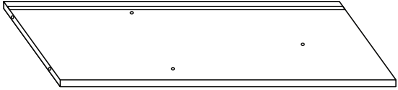









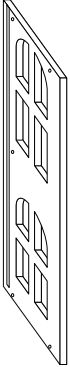
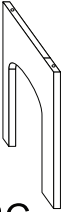

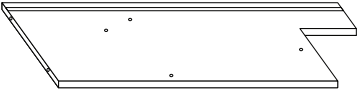

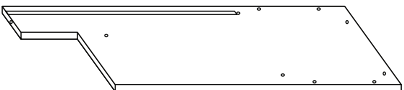
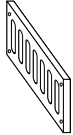

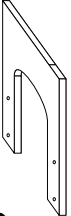
 1: 1PC	 2: 1PC	 5: 1PC	 7: 1PC	
	 3: 1PC	 4: 2PCS	 6: 1PC	
 8: 1PC	 9: 1PC	 10: 1PC	 11: 2PCS	
 12: 1PC	 13: 1PC	 14: 1PC	 15: 1PC	
 16: 1PC	 17: 1PC	 18: 1PC	 19: 1PC	 20: 1PC
4x40mm  A: 24PCS	4x20mm  B: 4PCS	4x30mm  C: 18PCS	 D: 1PC	

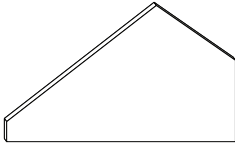
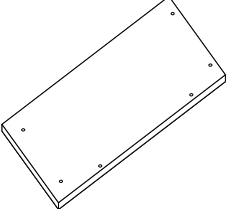
Step 1

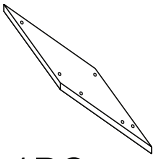
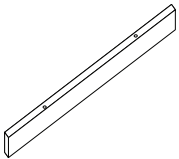

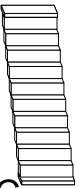
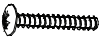
Secure Side Panel 1 to Panel 2 using 2 x Screws A.

Step 2

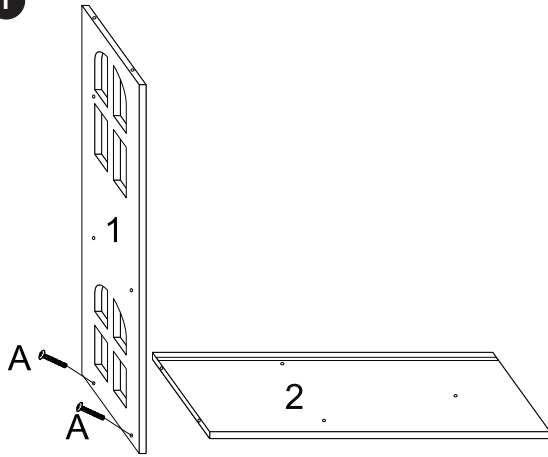
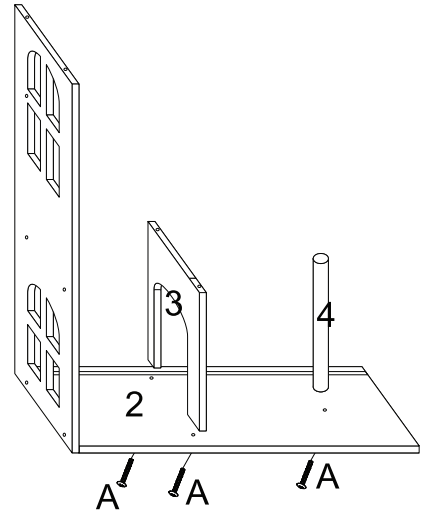

Secure Panel 3 to Panel 2 using 2 x Screws A. Secure Support Column 4 to Panel 2 using 1 x Screw A.

Step 3

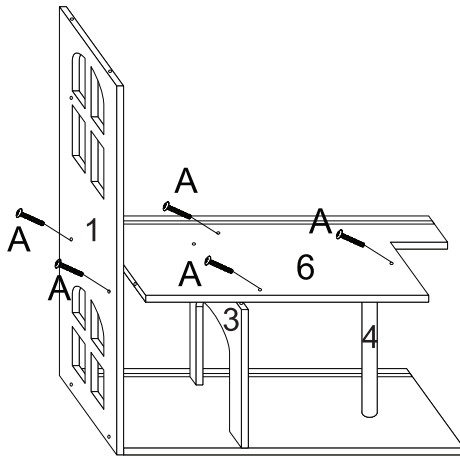

Use 2 x Screws A to secure Panel 6 to Side Panel 1. Use Screws A to Secure Panel 6 to Panel 3 and Support Column 4.

Step 4

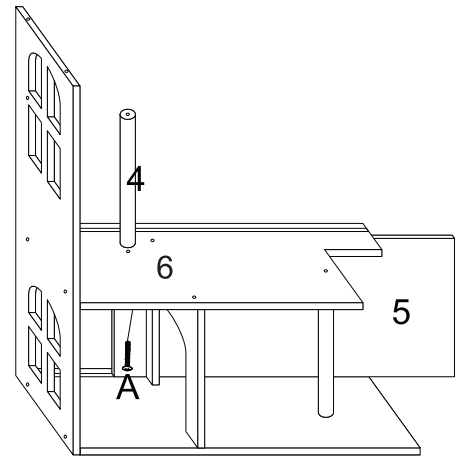

Insert Back Panel 5 in backside groove. Secure Support Column 4 to Panel 6 using 1 x Screw A.

Step 5

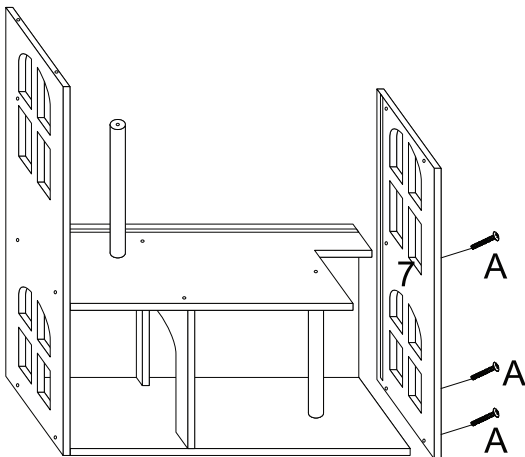

Secure Panel 7 on right side using 3 x Screws A.

Step 6

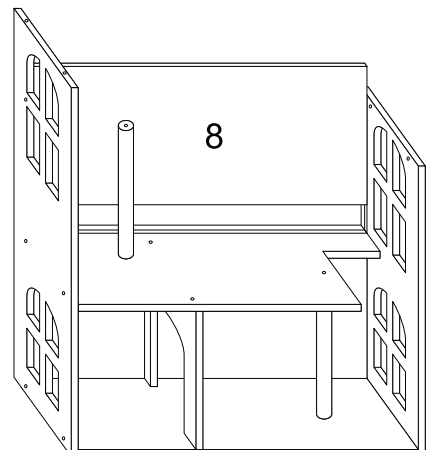

Insert Back Panel 8 in backside groove.

Step 7

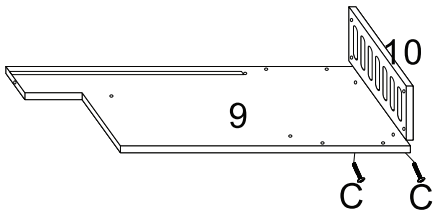

Secure Panel 10 to Panel 9 using 2 x Screws C.

Step 8

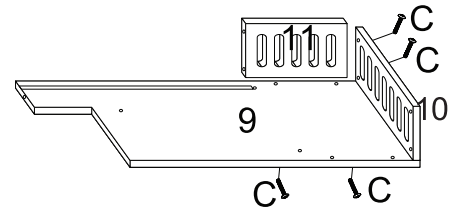

Secure Panel 11 to Panel 9 using 2 x Screws C.
Secure Panel 10 to Panel 11 using 2 x Screws C.

Step 9

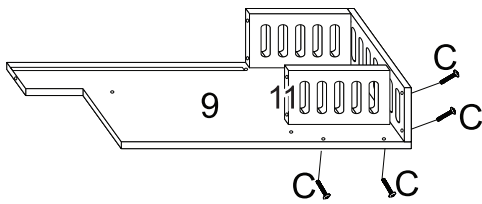

Secure Panel 11 to Panel 9 using 2 x Screws C.
Secure Panel 10 to Panel 11 using 2 x Screws C.

Step 10

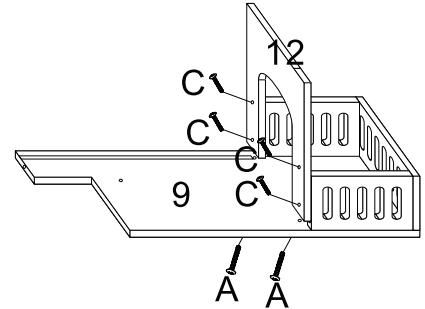

Secure Panel 12 to Panels 11 using 4 x Screws C.
Secure Panel 12 to Panel 9 using 2 x Screws A.

Step 11

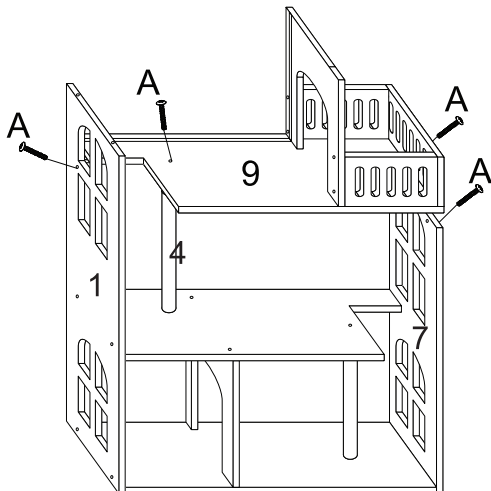

Use 1 x Screw A to secure Panel 9 to Support Column 4.
Use Screws A to secure Panel 9 to side Panels 1 and 7.

Step 12

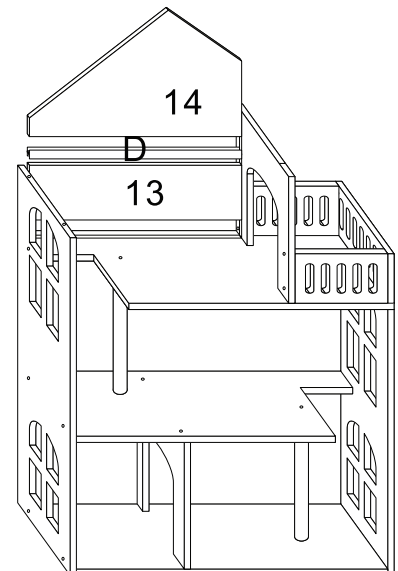

Insert Back Panel 13 in to groove.
Attach Plastic Bar D to Panel 13.
Insert Back Panel 14 in to Plastic Bar D.

Step 13

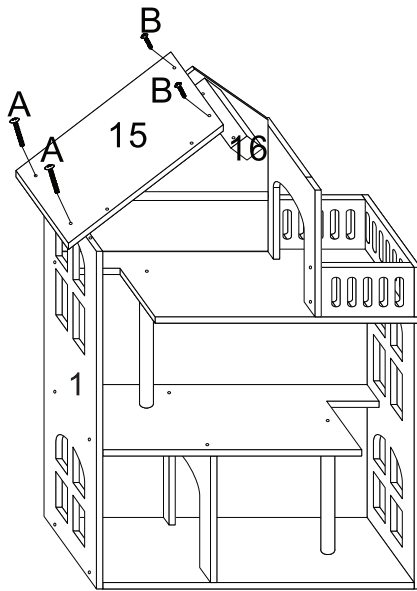

Use 2 x Screws A to secure Panel 15 to Panel 1.
Use 2 x Screws B to secure Panel 15 to Apex Panel 16.

Step 14

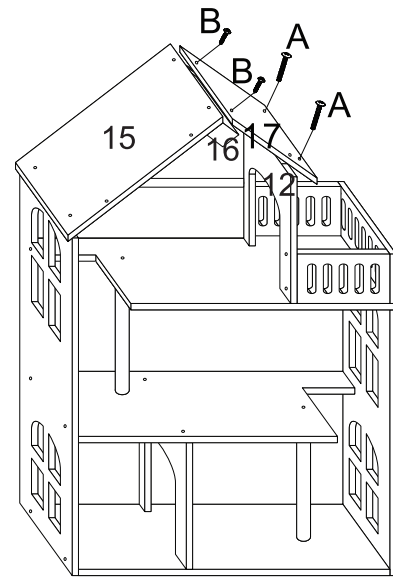

Use 2 x Screws A to secure Panel 17 to Panel 12.
NB: Squeeze Panel 15 and Panel 17 together when screwing Panel 17 to ensure a tight fix to Apex Panel 16.
Use 2 x Screws B to secure Panel 17 to Apex Panel 16.

Step 15

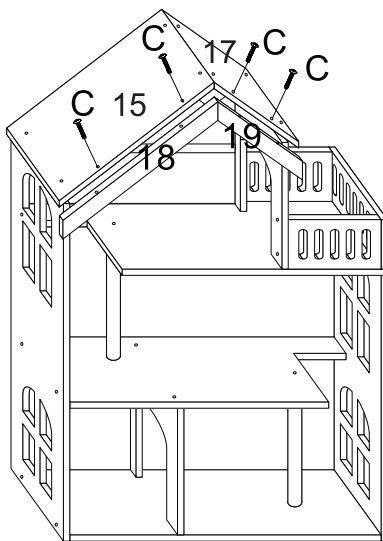

Use 2 x Screws C to secure Panel 15 to Panel 18.
Use 2 x Screws C to secure Panel 17 to Panel 19.

Step 16

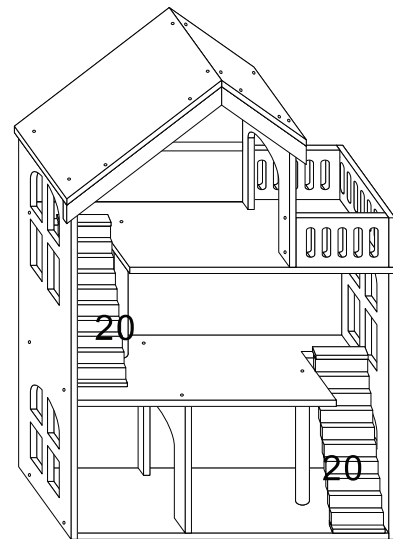

Insert 2 x Staircase 20.
Assembly is complete.