



# SPORTING PANEL MY-PLAY GYM

BABY KIT  
#1139

DEVELOP

- Can make a slide or furniture.
- Safe & Tough!
- 10 different models can be build!
- Environmental protection!

so much fun!!

fun & Safe!!



1+

● Locking joints disassemble in seconds using included pliers!

★ Parental or guardian's supervision required!!

# Jungle 1-3 years



# Slide 1-5 years



# Furniture 1&up



Furniture 1



Furniture 4

▶ The storage bag is not included. You may use laundry bag or poly bag for it.



Furniture 3



Furniture 2

# CATEGORY

Parts List.....	4
Assembly & Disassembly.....	5-6
Assembly Illustration	
Jungle.....	7-10
Slide.....	11-18
Furniture.....	19-26

# #1139 PARTS LIST

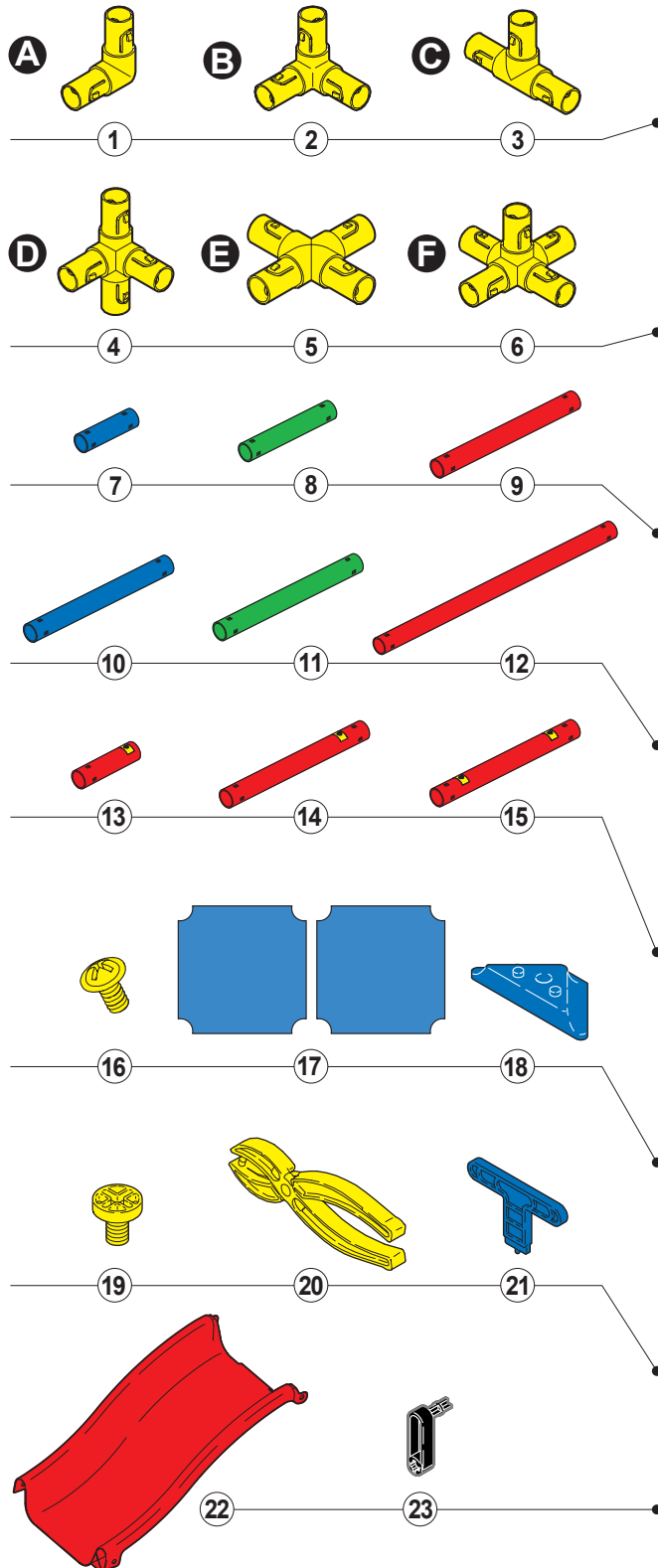

NO.	PARTS NAME	Q'TY
1	Corner Connector	8
2	3-Way Connector	12
3	T-Connector	4
4	4-Way Connector	10
5	Cross Connector	1
6	5-Way Connector	3
7	Tube (105mm / Blue )	8
8	Tube (143mm / Green )	8
9	Tube (300mm / Red )	10
10	Tube (300mm / Blue )	10
11	Tube (300mm / Green )	10
12	Tube (550mm / Red )	2
13	Single Locking Tube (95mm / Red )	2
14	Single Locking Tube (300mm / Red )	2
15	Double Locking Tube (300mm / Red )	1
16	Tube Screw	6
17	Square Flat	2
18	Fixture	8
19	Screw	8
20	Release Pliers	2
21	T Wrench	1
22	Slide	1
23	Screw Driver	2

**Total : 121**

# #1139 ASSEMBLY & DISASSEMBLY 1

## • How to Assemble & Disassemble Tube and Connector

### ⚠ Note:

Do not hold tube and connectors where you insert each piece as finger may be pinched.

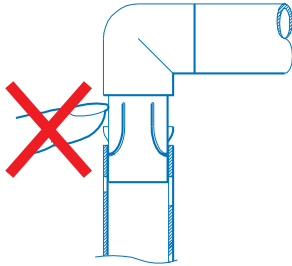

Fig. 1

(1) Push the connector into tube and turn the tube until a "click" is heard.

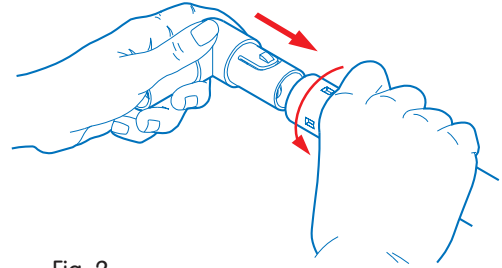

Fig. 2

(2) Finish the assembly of both connectors with the tube in between. Then insert the connectors into two separate tubes to complete a panel. (Fig. 3-1)

⚠ not assemble the tubes and connectors one by one. (Fig. 3-2)

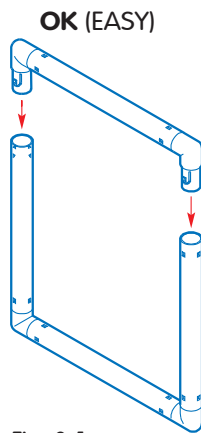

Fig. 3-1

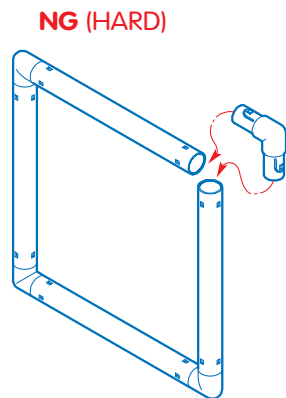

Fig. 3-2

(3) Put release pliers into holes that have safety lock pins coming through and squeeze the pliers to release the tube from the connector.

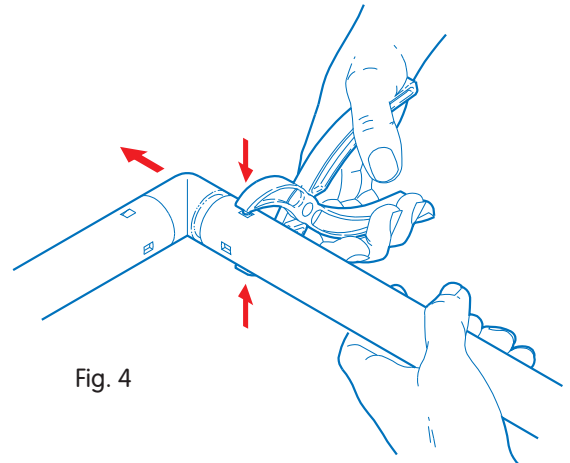

Fig. 4

## • How to fix square flat onto tube frame

(1) Use fixture and screw to fix square flat onto tube frame and then screw them together with T wrench as Fig. 5 shows.

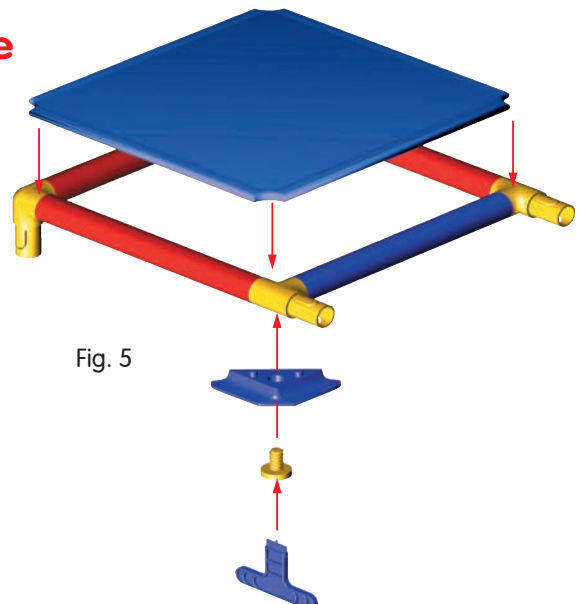

Fig. 5

## ASSEMBLY & DISASSEMBLY 2

### ● How to Fasten the Slide

(1) After the model is constructed make sure to fasten all the ends of slide to the tubes with the tube screws and screw driver as Fig. 6-1 shows or double screw driver as Fig. 6-2 shows.

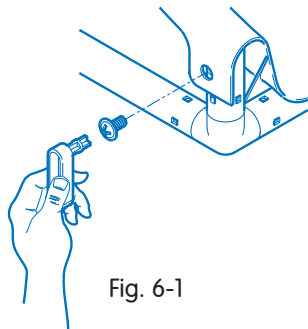

Fig. 6-1

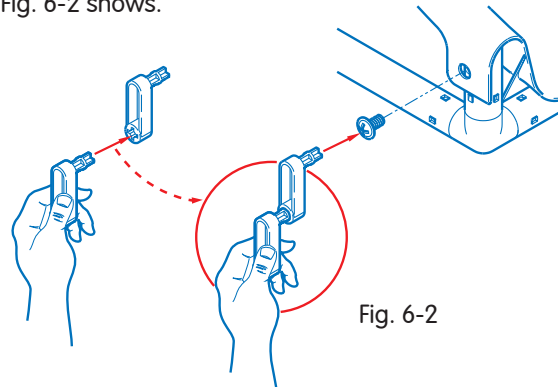

Fig. 6-2

(2) Double Locking Tube (300mm/Red) is the part used to fix the bottom of slide, the nuts on the tube are fixed in a definite angle. If the tube is misplaced, the tube screws can't fasten the tube to the bottom of slide in a proper condition. Please do place Double Locking Tube correctly as Fig. 7-1 shows while assembly.

1. The Double Locking Tube must be placed so that the arrow mark on the label would face upward when it is looked from inside of the model. Please refer to the Fig. 7-2.

2. Fasten the Double Locking Tube to the bottom of slide with 2 tube screws and double screw driver.

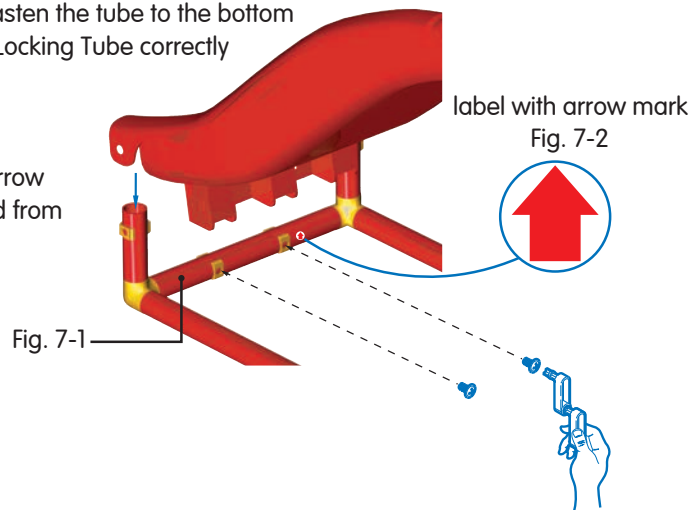

Fig. 7-1

label with arrow mark  
Fig. 7-2

### ● Safety notice

Parents or guardians must read the instruction manual and the following notice carefully before use in order to assure safety. And retain them for future reference.

#### 1. Notice for assembly and settlement

- Parents or guardians must read the instruction manual carefully and assemble gyms accordingly.
- During assembly, be sure to keep small parts away from young kids so that they would not be swallowed.
- The gyms are specially designed for indoor use. Please settle it on a flat floor.
- Don't settle gyms near a stove or fire.

#### 2. Notice for use

- To be used only under parental or guardian's supervision.
- To inspect tubes, connectors and fixing parts periodically to make sure they are always well fixed.
- To use it only if the structure is stable.
- To use it with bare feet to avoid slip.
- Don't jump over gym, or from a high position of gym to floor.
- Don't play it rudely.
- Don't have two or more kids stand or sit on the same single tube at the same time.
- These gyms are specially designed for young kids aged one year up to 5 years.  
Don't have them used by the ones beyond this age range.

# #1139 ASSEMBLY ILLUSTRATION

## Jungle 1

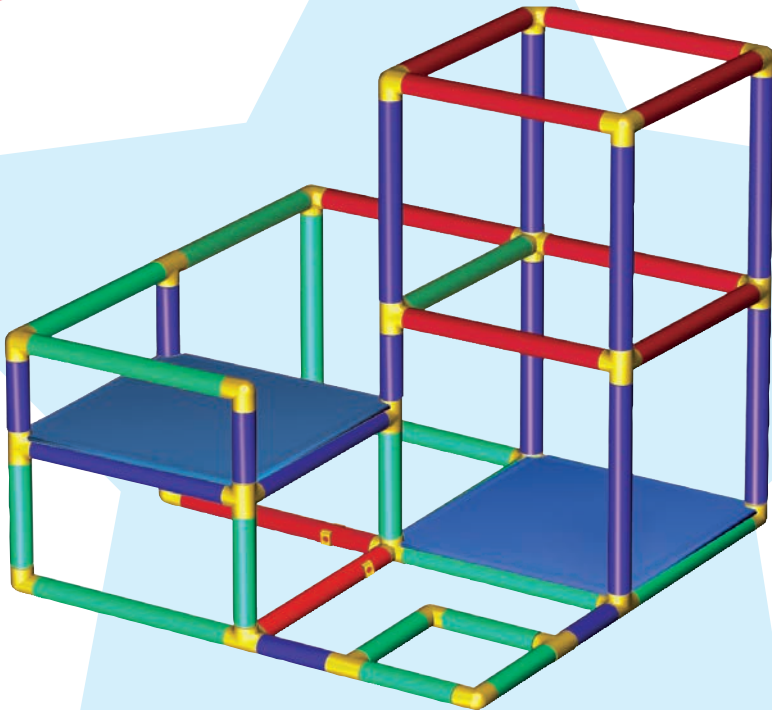

**COMPLETED**

716mm W x 716mm D x 716mm H

1

2

3

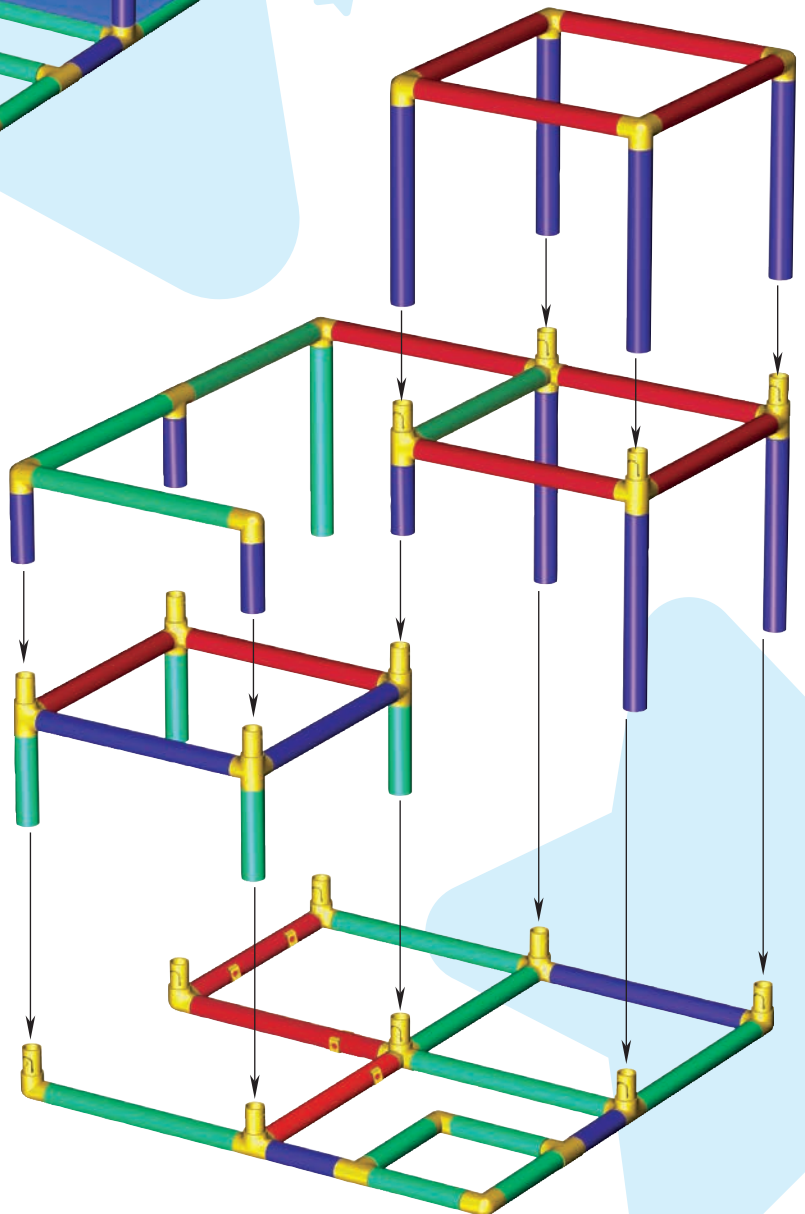
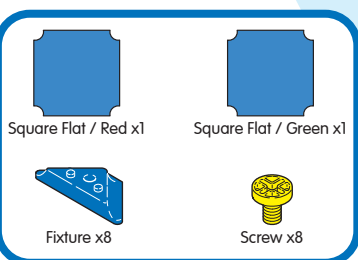

4











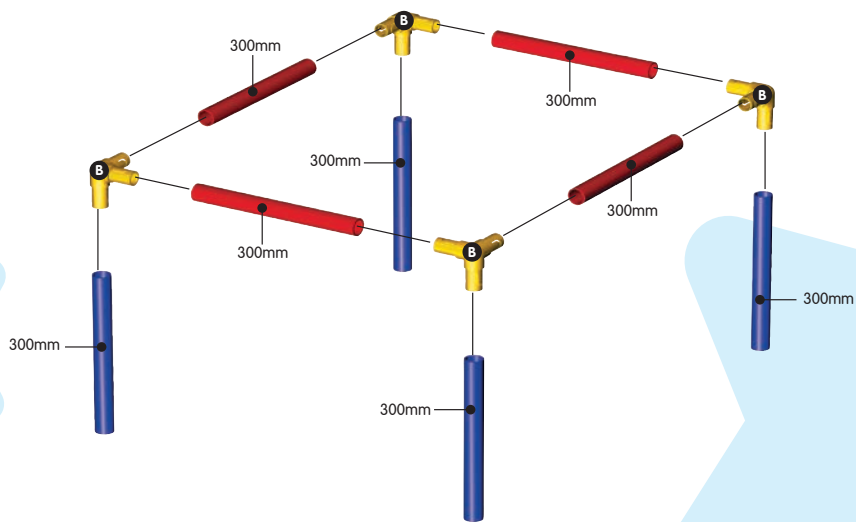



# ASSEMBLY ILLUSTRATION

1

-  x4
-  Tube (300mm / Red) x4
-  Tube (300mm / Blue) x4





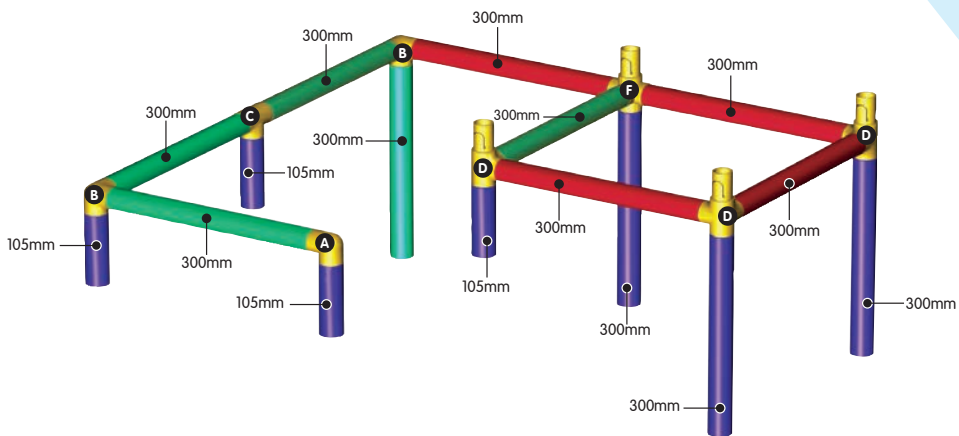

2

-  x1
-  x2
-  x1
-  x3
-  x1
-  Tube (105mm / Blue) x4
-  Tube (300mm / Red) x4
-  Tube (300mm / Blue) x3
-  Tube (300mm / Green) x5







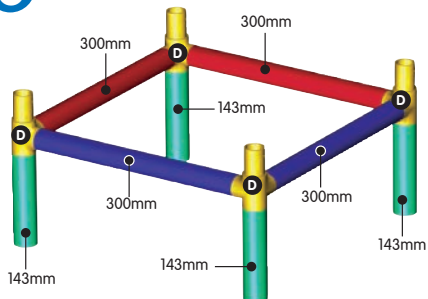





3

-  x4
-  Tube (143mm / Green) x4
-  Tube (300mm / Red) x2
-  Tube (300mm / Blue) x2



4

-  x3
-  x3
-  x2
-  x3
-  x1
-  Tube (105mm / Blue) x2
-  Tube (143mm / Green) x4
-  Tube (300mm / Blue) x1
-  Tube (300mm / Green) x5
-  Single Locking Tube (300mm / Red) x2
-  Double Locking Tube (300mm / Red) x1

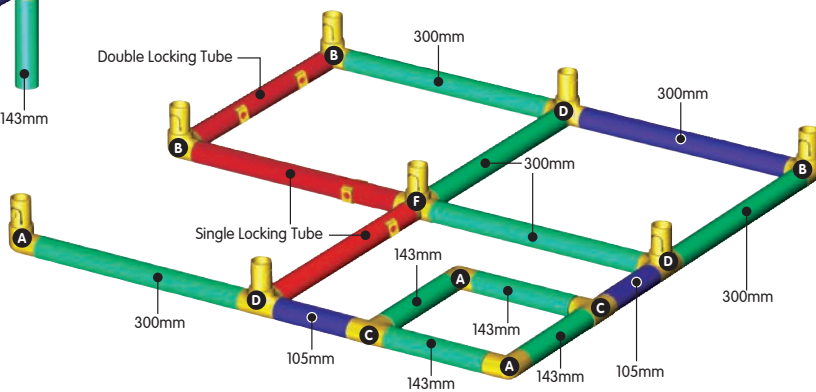

# #1139 ASSEMBLY ILLUSTRATION

## Jungle 2

**COMPLETED**

1068mm W x 716mm D x 716mm H

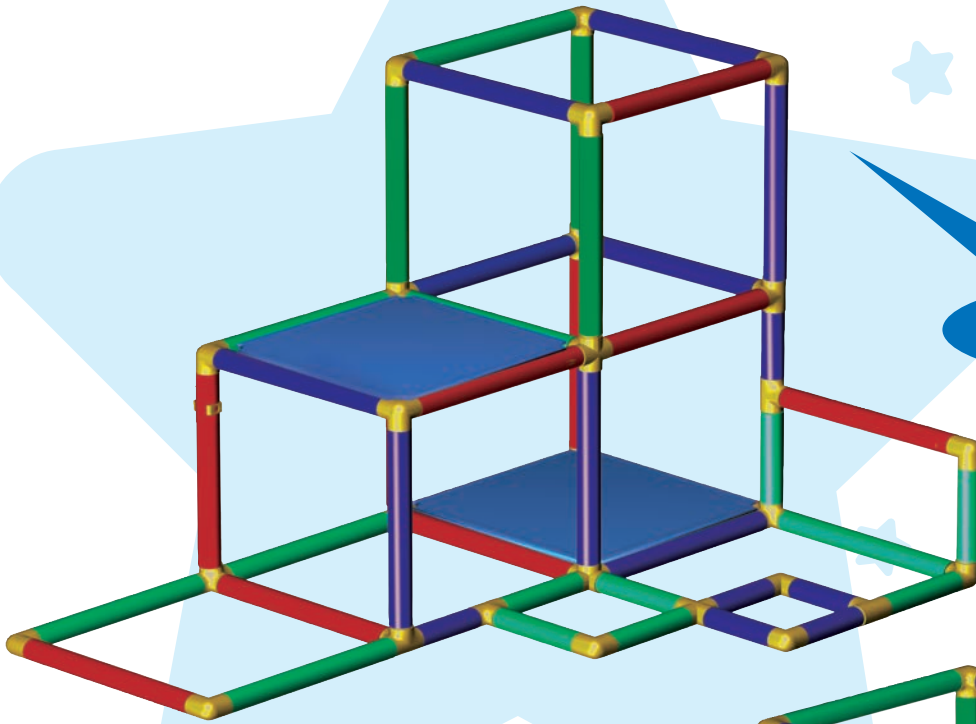

1

2

3

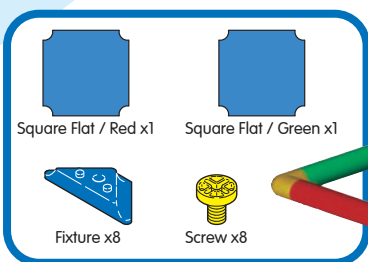

9

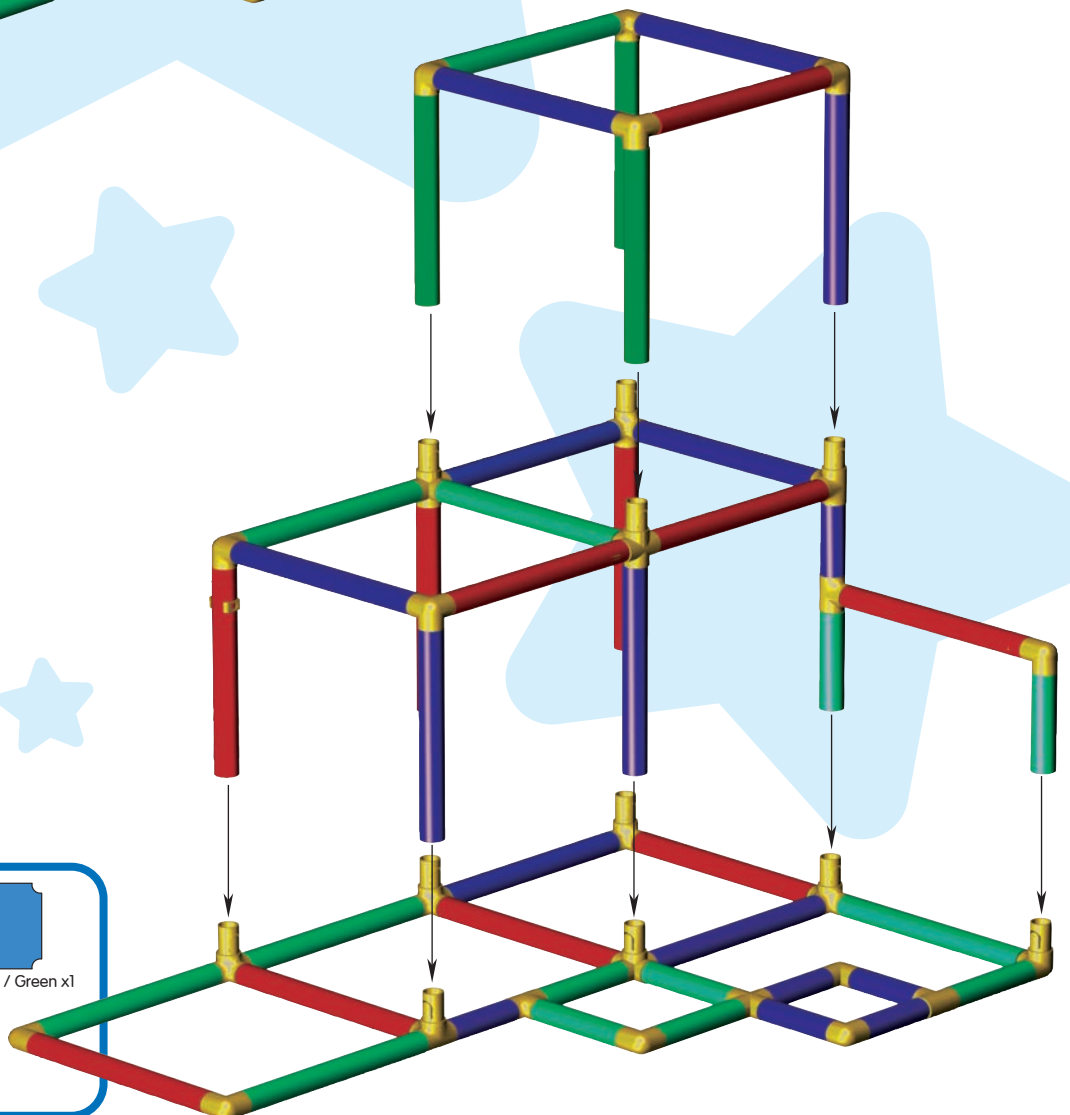

# ASSEMBLY ILLUSTRATION

1

**B**  x4

 Tube (300mm / Red) x1

 Tube (300mm / Blue) x3

 Tube (300mm / Green) x4

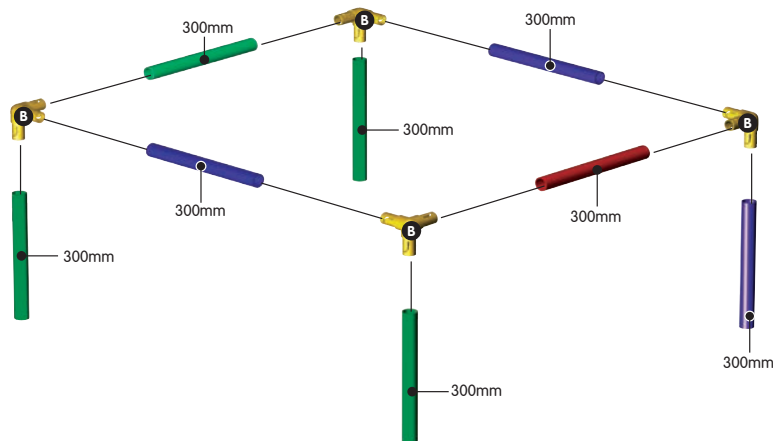

2

**A**  x1

**B**  x2

**C**  x1

**D**  x2

**F**  x2

 Tube (105mm / Blue) x1

 Tube (143mm / Green) x2

 Tube (300mm / Red) x5

 Tube (300mm / Blue) x5

 Tube (300mm / Green) x2

 Single Locking Tube (300mm / Red) X1

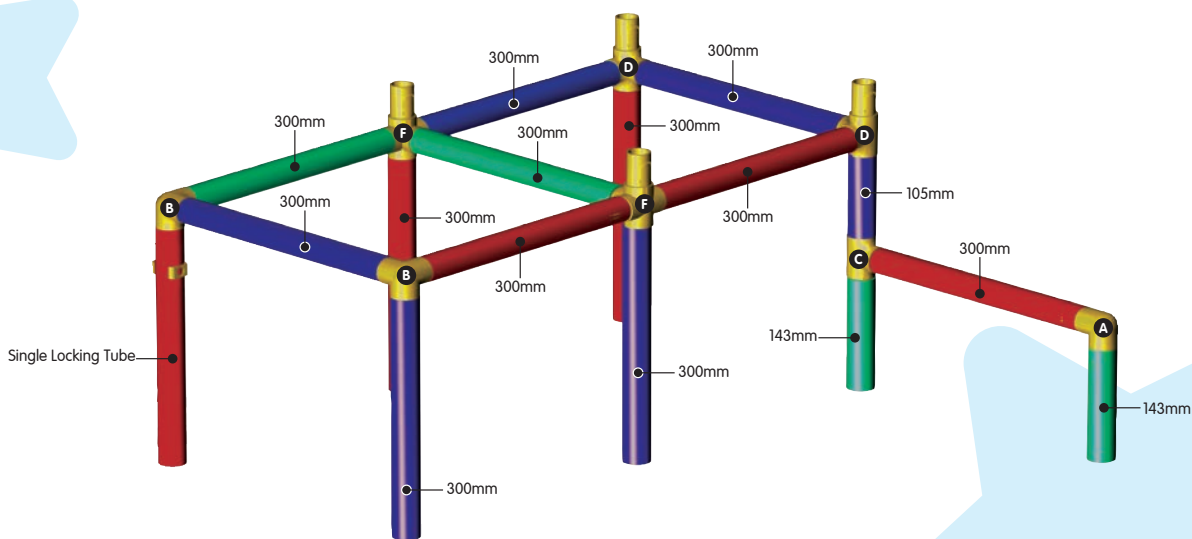

3

**A**  x5

**B**  x2

**C**  x2

**D**  x4

**E**  x1

**F**  x1

 Tube (105mm / Blue) x5

 Tube (143mm / Green) x5

 Tube (300mm / Red) x4

 Tube (300mm / Blue) x2

 Tube (300mm / Green) x4

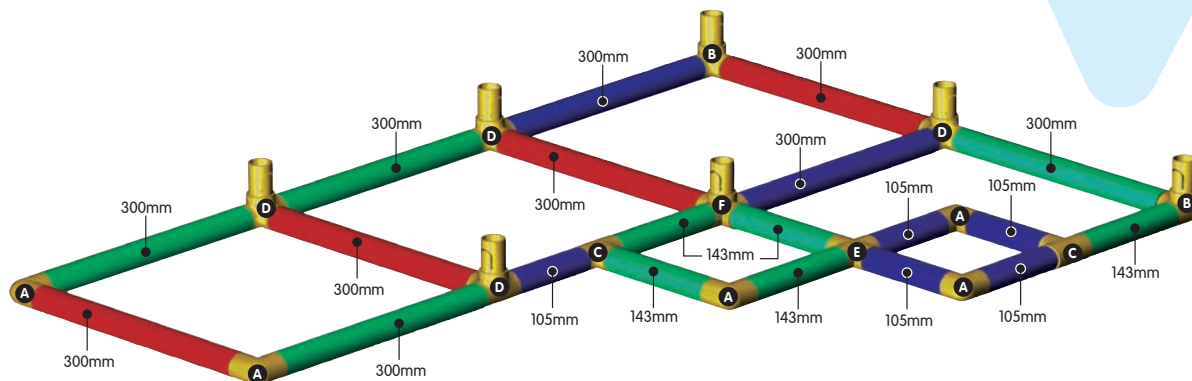

# #1139 ASSEMBLY ILLUSTRATION

Slide 1

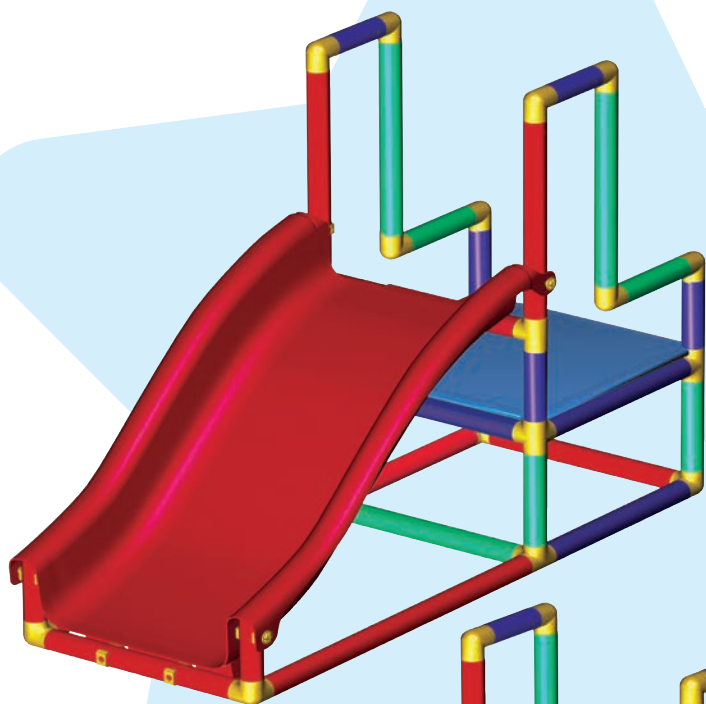

966mm W x 364mm D x 716mm H

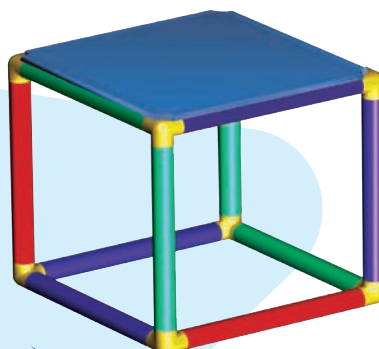

364mm W x 364mm D x 364mm H

COMPLETED

1

2

3

4

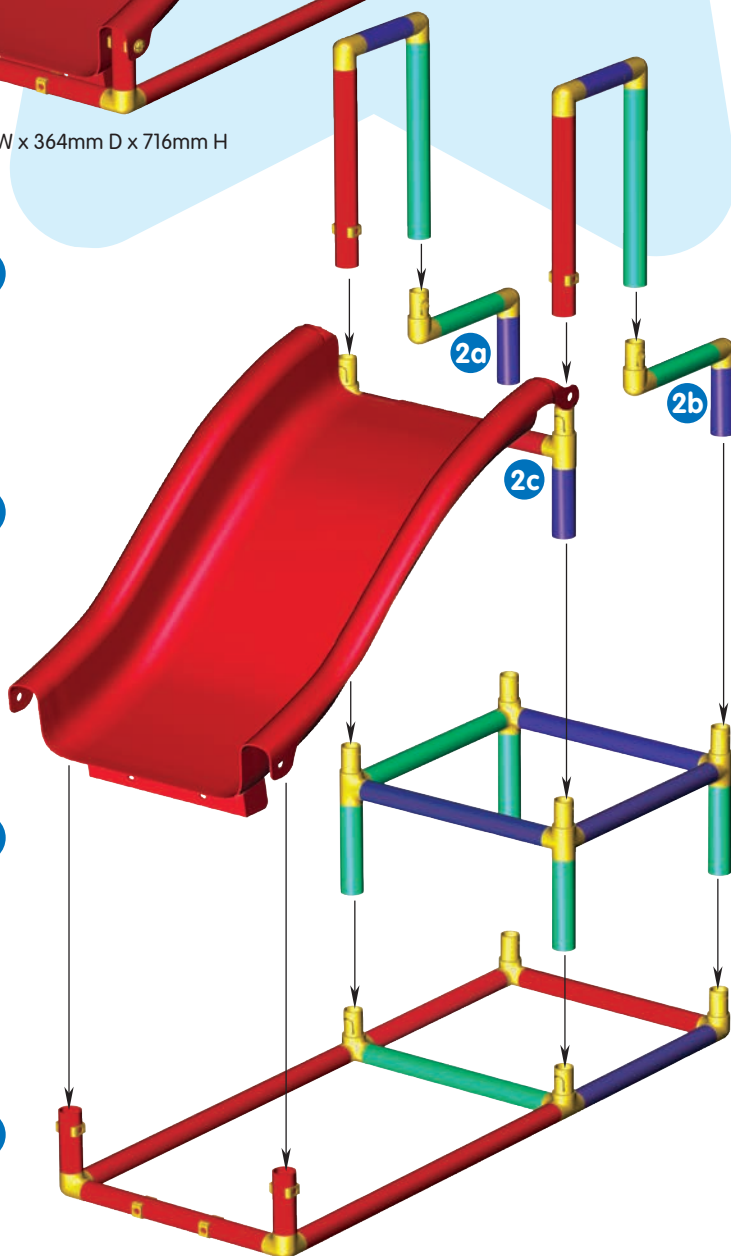

5

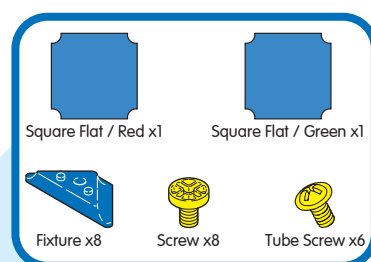
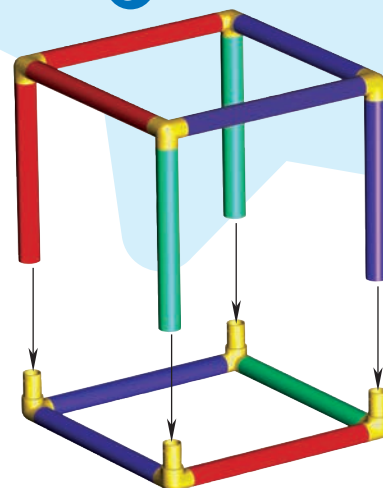

# ASSEMBLY ILLUSTRATION

1

A  x4

 Tube (105mm / Blue) x2

 Tube (300mm / Green) x2

 Single Locking Tube (300mm / Red) x2

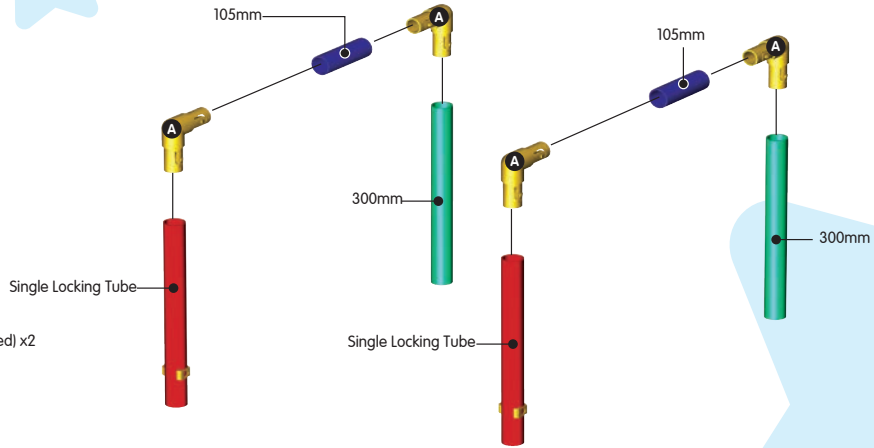

2

A  x4

C  x2

 Tube (105mm / Blue) x4

 Tube (143mm / Green) x2

 Tube (300mm / Red) x1



2c

C

105mm

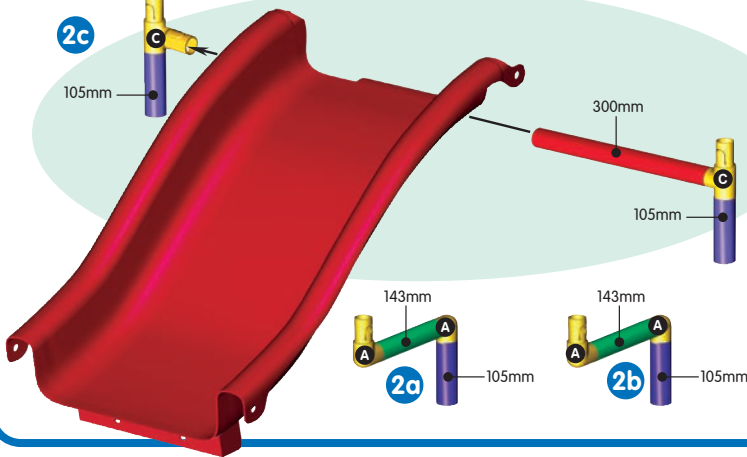

3

D  x4

 Tube (143mm / Green) x4

 Tube (300mm / Blue) x3

 Tube (300mm / Green) x1

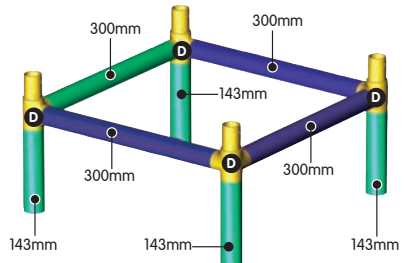

4

B  x4

D  x2

 Tube (300mm / Red) x2

 Tube (300mm / Blue) x1

 Tube (300mm / Green) x1

 Tube (550mm / Red) x2

 Single Locking Tube (95mm / Red) x2

 Double Locking Tube (300mm / Red) x1

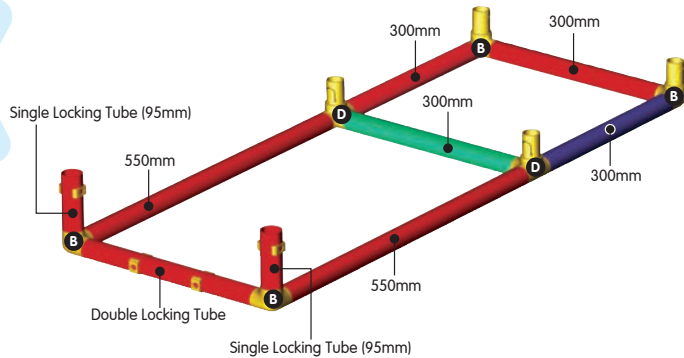

5

B  x8

 Tube (300mm / Red) x4

 Tube (300mm / Blue) x5

 Tube (300mm / Green) x3

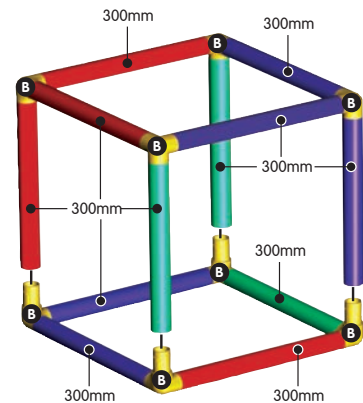

# #1139 ASSEMBLY ILLUSTRATION

Slide 2

COMPLETED

1318mm W x 364mm D x 716mm H



1

2

3

4

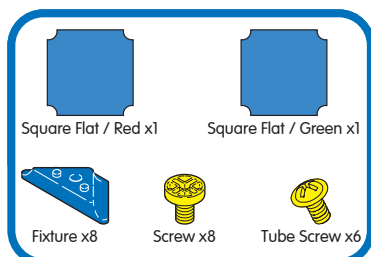
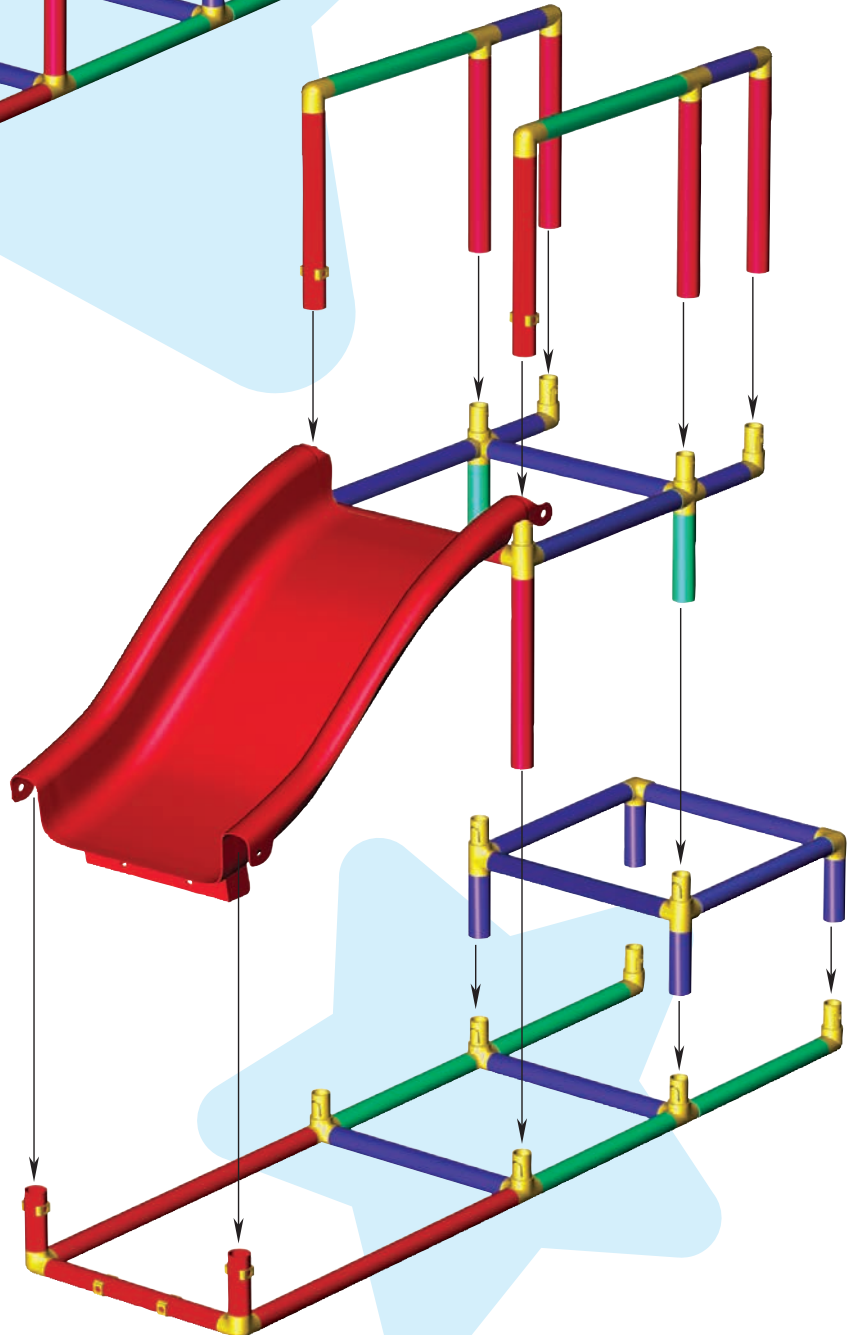

# ASSEMBLY ILLUSTRATION

1

A  x4

C  x2

 Tube (105mm / Blue) x2

 Tube (300mm / Red) x4

 Tube (300mm / Green) x2

 Single Locking Tube (300mm / Red) X2

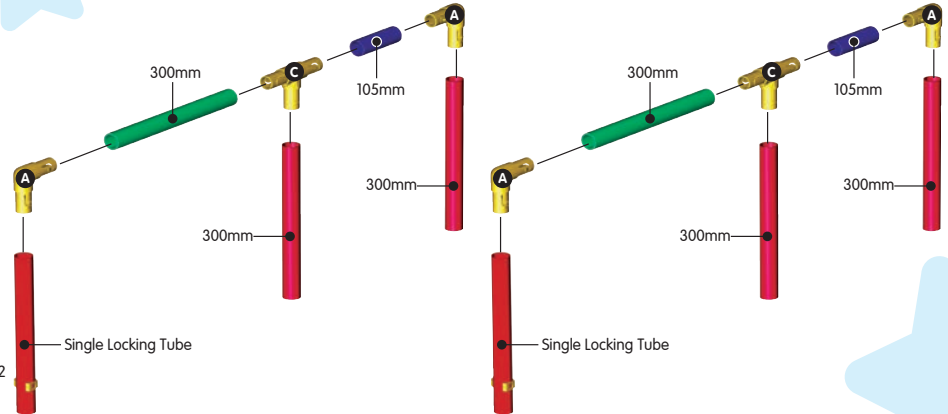

2

A  x2

D  x2

F  x2

 Tube (105mm / Blue) x2

 Tube (143mm / Green) x2

 Tube (300mm / Red) x3

 Tube (300mm / Blue) x3

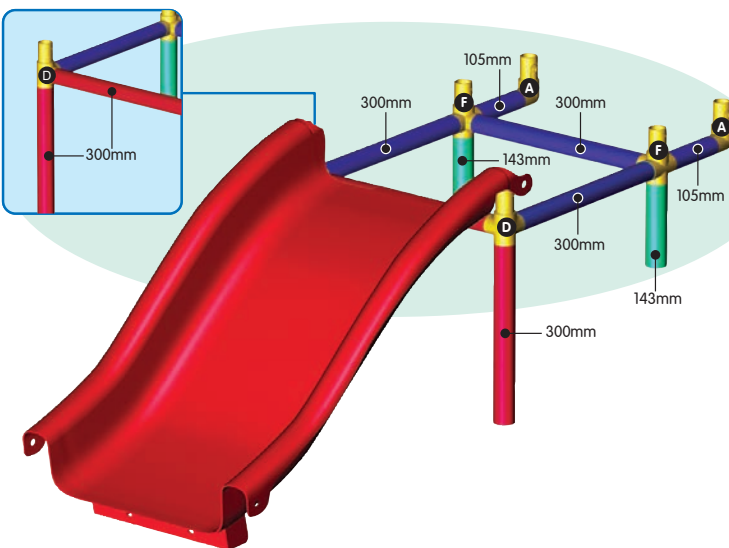

3

B  x2

D  x2

 Tube (105mm / Blue) x4

 Tube (300mm / Blue) x4

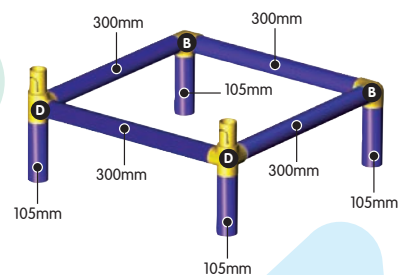

4

A  x2

B  x2

D  x4

 Tube (300mm / Blue) x2

 Tube (300mm / Green) x4

 Tube (550mm / Red) X2

 Single Locking Tube (95mm / Red) X2

 Double Locking Tube (300mm / Red) X1

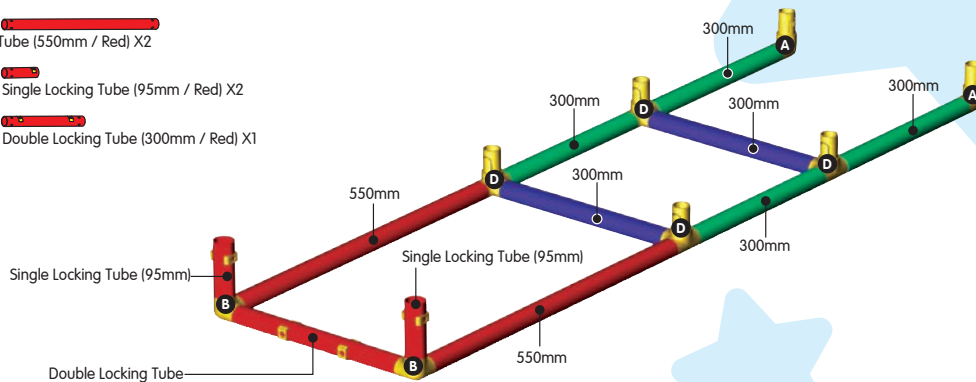

# #1139 ASSEMBLY ILLUSTRATION

Slide 3

COMPLETED

966mm W x 716mm D x 716mm H

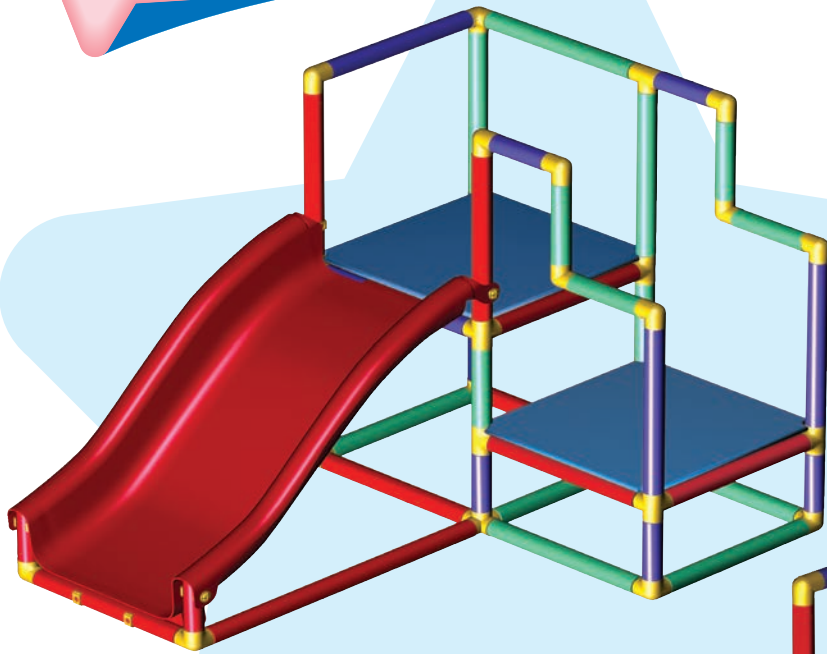

1

2

3

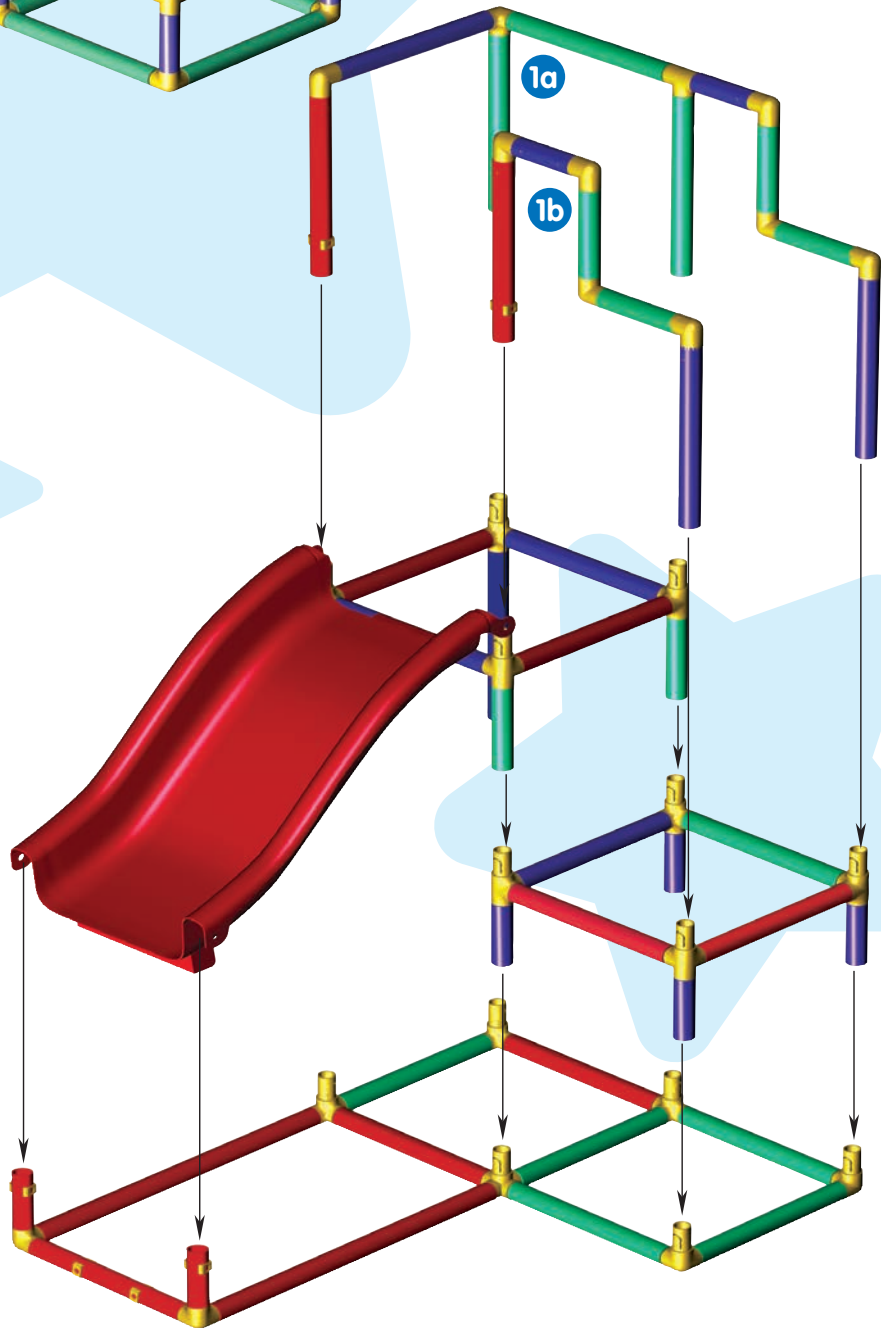
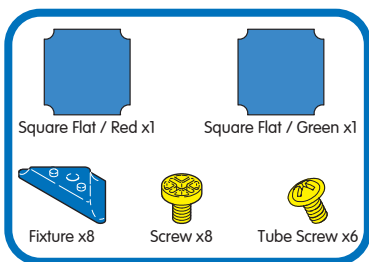

4







# ASSEMBLY ILLUSTRATION



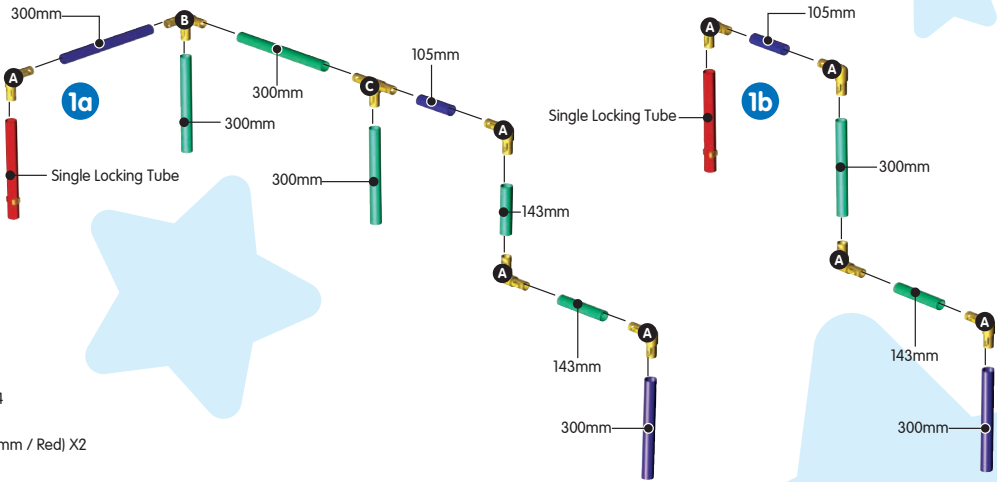

1

- A  x8
- B  x1
- C  x1

-  Tube (105mm / Blue) x2
-  Tube (143mm / Green) x3
-  Tube (300mm / Blue) x3
-  Tube (300mm / Green) x4
-  Single Locking Tube (300mm / Red) X2





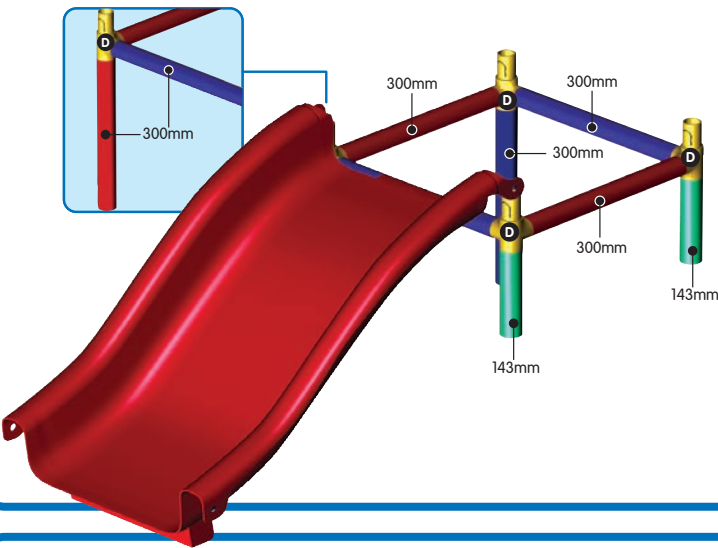

2

- D  x4
-  Tube (143mm / Green) x2
-  Tube (300mm / Red) x3
-  Tube (300mm / Blue) x3
-  Slide X1







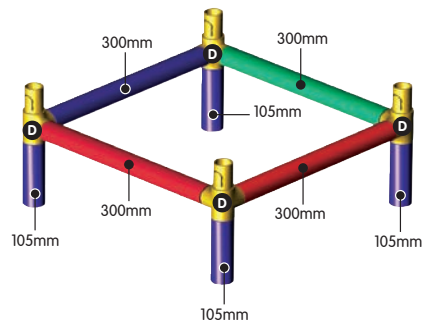



3

- D  x4
-  Tube (105mm / Blue) x4
-  Tube (300mm / Red) x2
-  Tube (300mm / Blue) x1
-  Tube (300mm / Green) x1



4

- B  x5
- D  x2
- F  x1
-  Tube (300mm / Red) x2
-  Tube (300mm / Green) x5
-  Tube (550mm / Red) X2
-  Single Locking Tube (95mm / Red) X2
-  Double Locking Tube (300mm / Red) X1

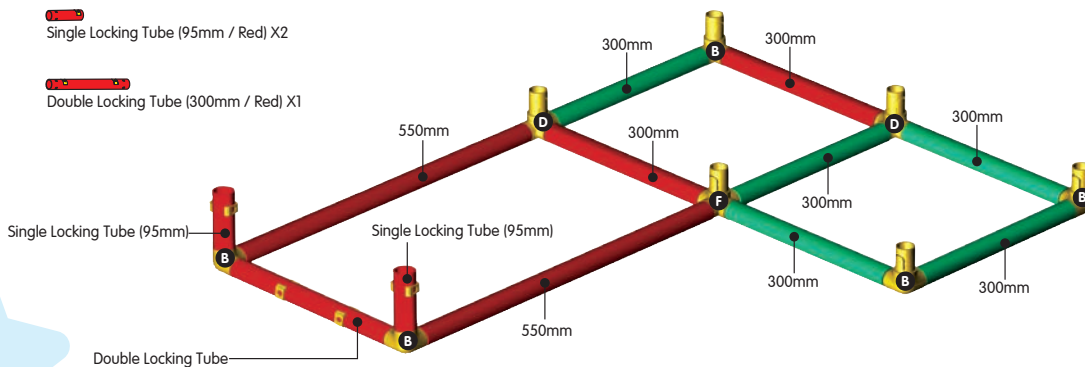

# #1139 ASSEMBLY ILLUSTRATION

Slide 4

**COMPLETED**

966mm W x 716mm D x 716mm H

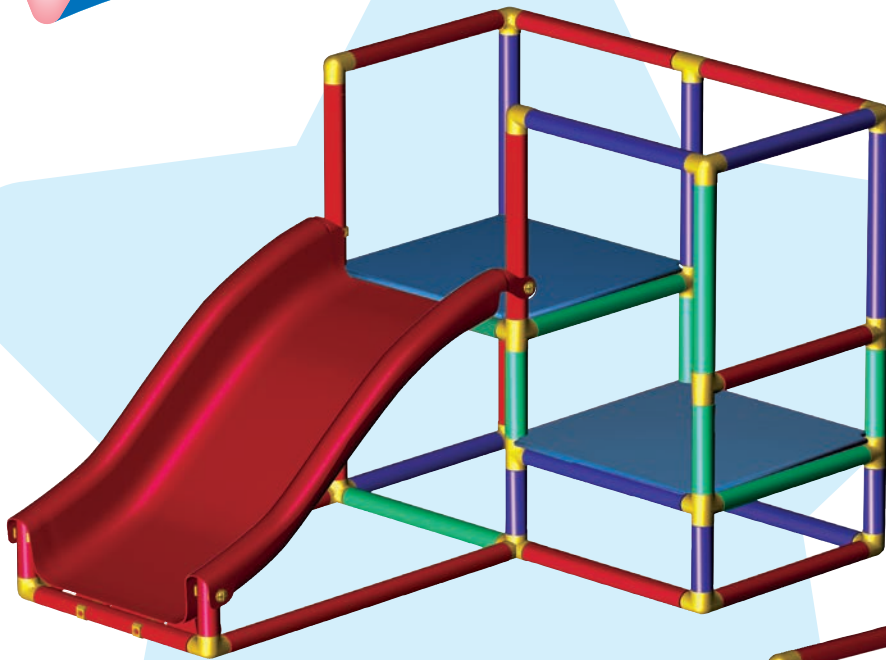

1

2

3

4

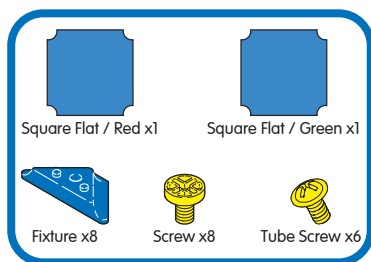
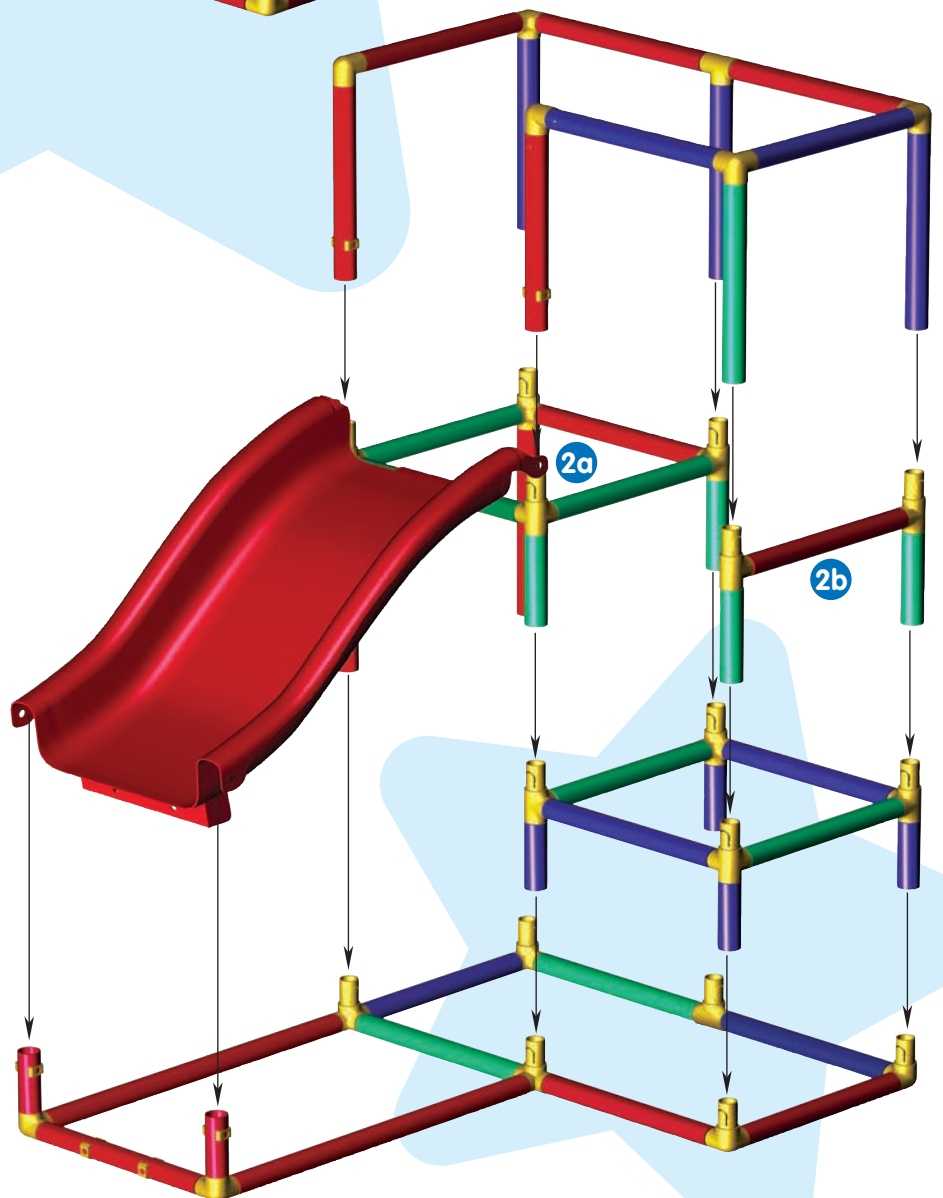

# ASSEMBLY ILLUSTRATION

1

A  x2

B  x3

C  x1

 Tube (300mm / Red) x3

 Tube (300mm / Blue) x5

 Tube (300mm / Green) x1

 Single Locking Tube (300mm / Red) X2

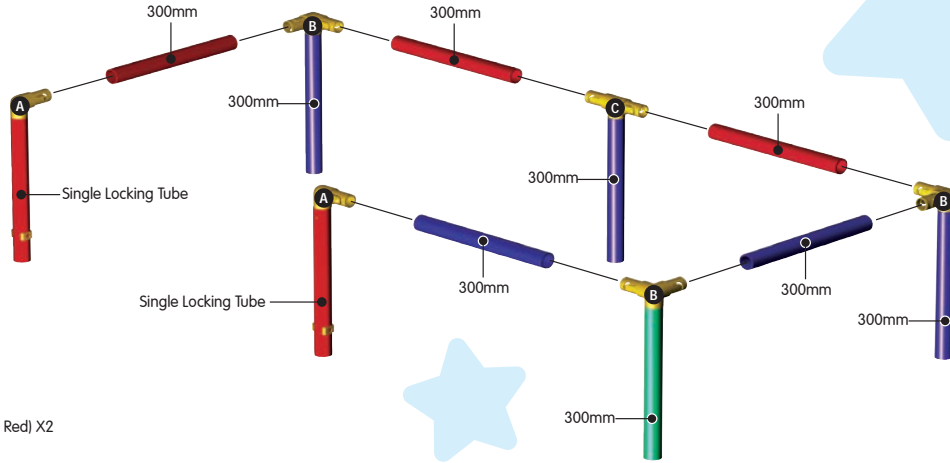

2

C  x2

D  x4

 Tube (143mm / Green) x4

 Tube (300mm / Green) x3

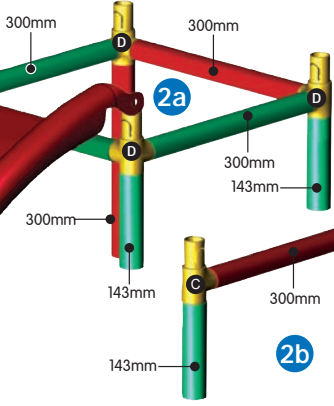
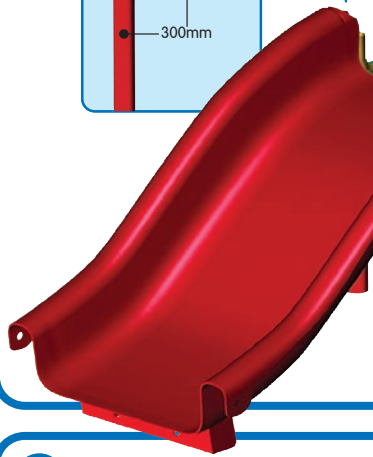
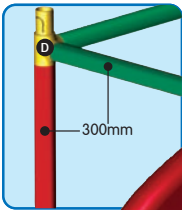

2b

3

D  x4

 Tube (105mm / Blue) x4

 Tube (300mm / Blue) x2

 Tube (300mm / Green) x2

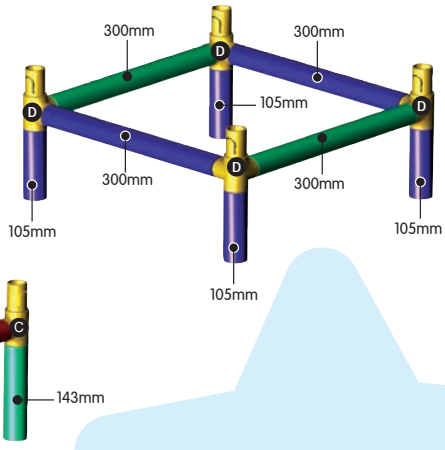

4

B  x5

C  x1

D  x2

 Tube (300mm / Red) x2

 Tube (300mm / Blue) x2

 Tube (300mm / Green) x2

 Tube (550mm / Red) X2

 Single Locking Tube (95mm / Red) X2

 Double Locking Tube (300mm / Red) X1

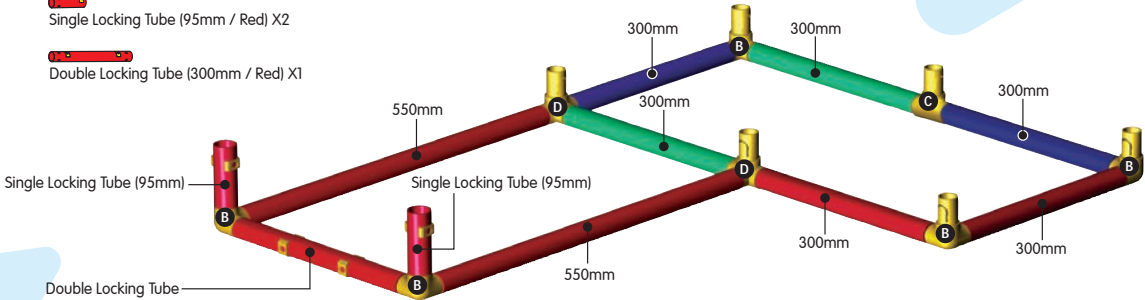

# #1139 ASSEMBLY ILLUSTRATION

## Furniture 1

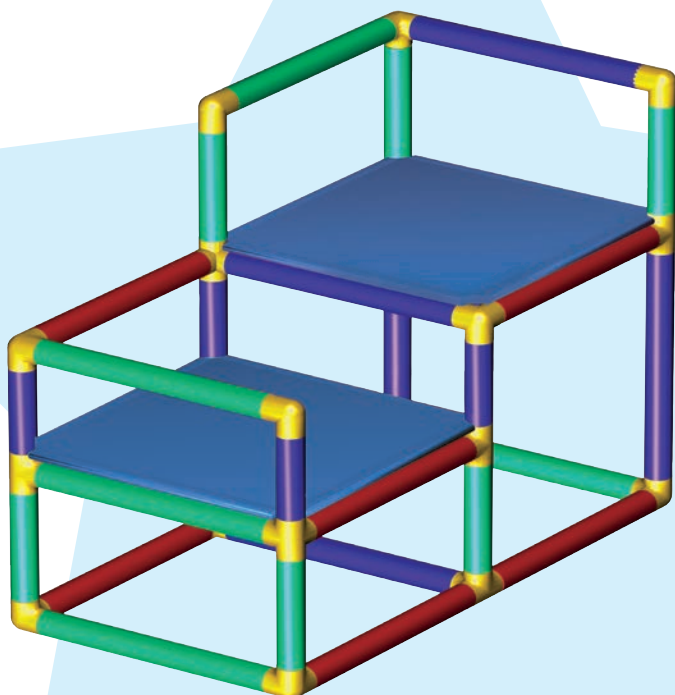

**COMPLETED**

716mm W x 364mm D x 559mm H

1

2



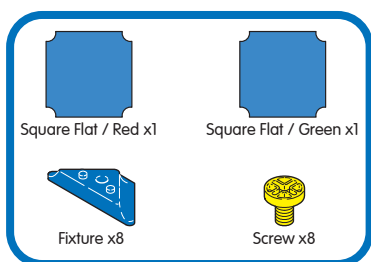

3

4









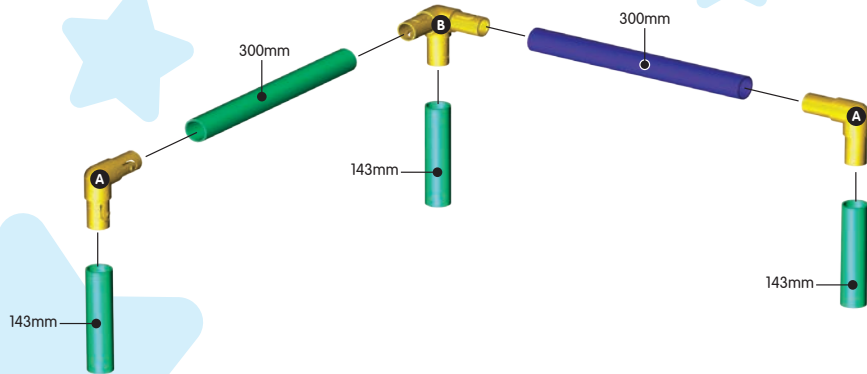

# ASSEMBLY ILLUSTRATION

1

-  x2
-  x1
-  Tube (143mm / Green) x3
-  Tube (300mm / Blue) x1
-  Tube (300mm / Green) x1





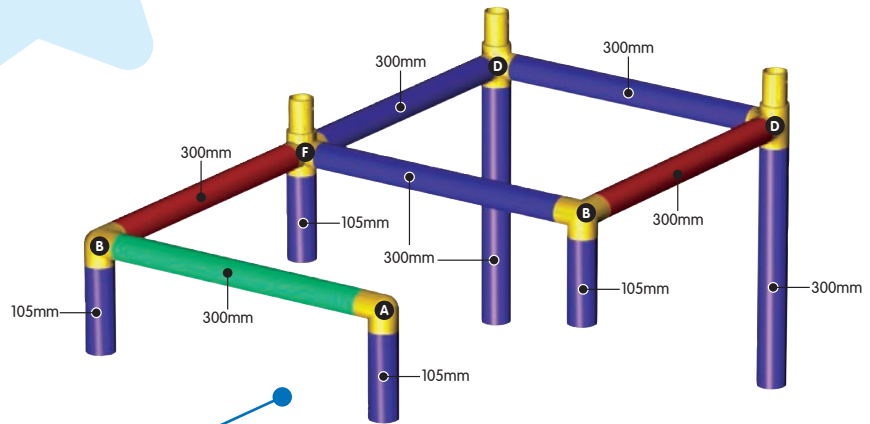

2

-  x1
-  x2
-  x2
-  x1
-  Tube (105mm / Blue) x4
-  Tube (300mm / Red) x2
-  Tube (300mm / Blue) x5
-  Tube (300mm / Green) x1





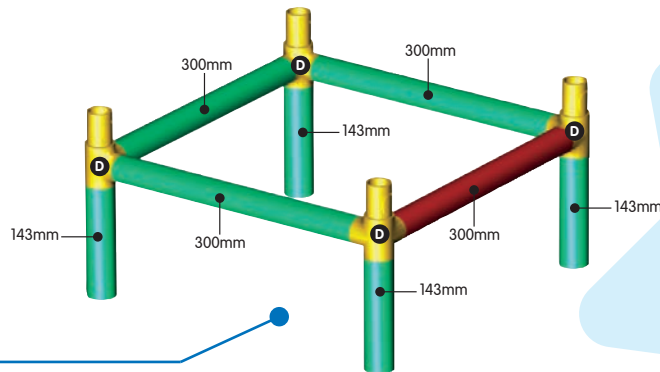

3

-  x4
-  Tube (143mm / Green) x4
-  Tube (300mm / Red) x1
-  Tube (300mm / Green) x3



4

-  x4
-  x2
-  Tube (300mm / Red) x4
-  Tube (300mm / Blue) x1
-  Tube (300mm / Green) x2

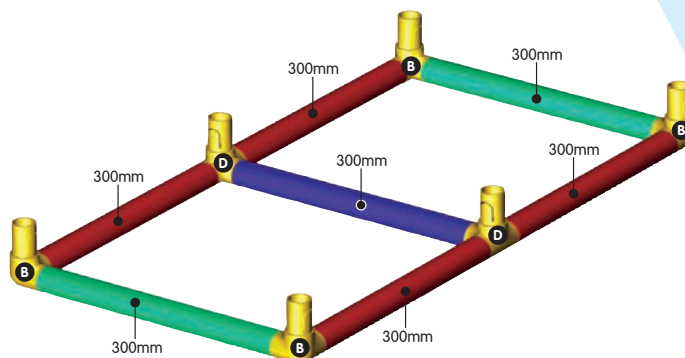

# #1139 ASSEMBLY ILLUSTRATION

## Furniture 2

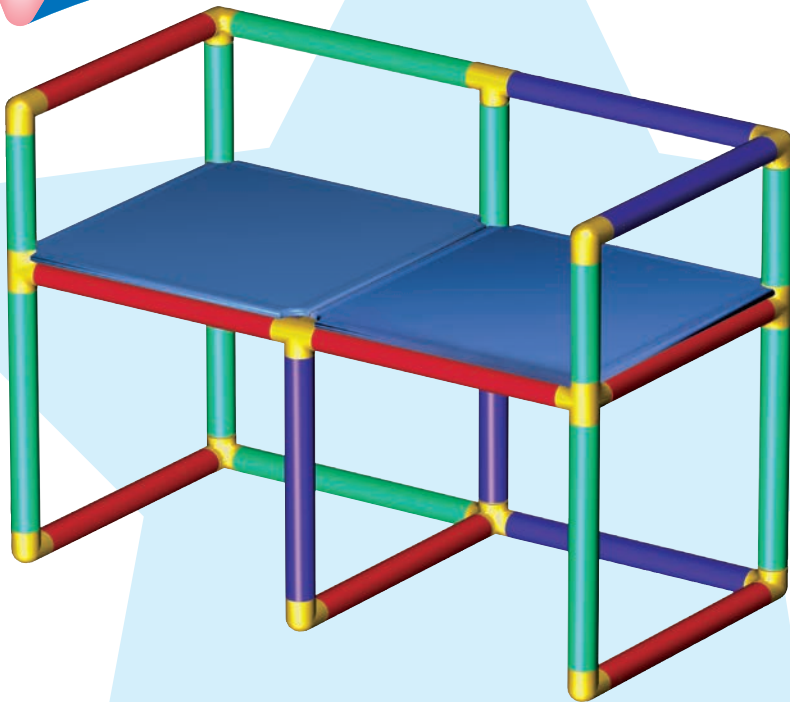

**COMPLETED**

716mm W x 364mm D x 559mm H

1

2

3

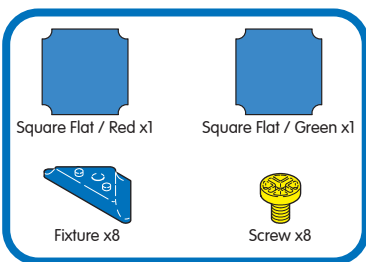
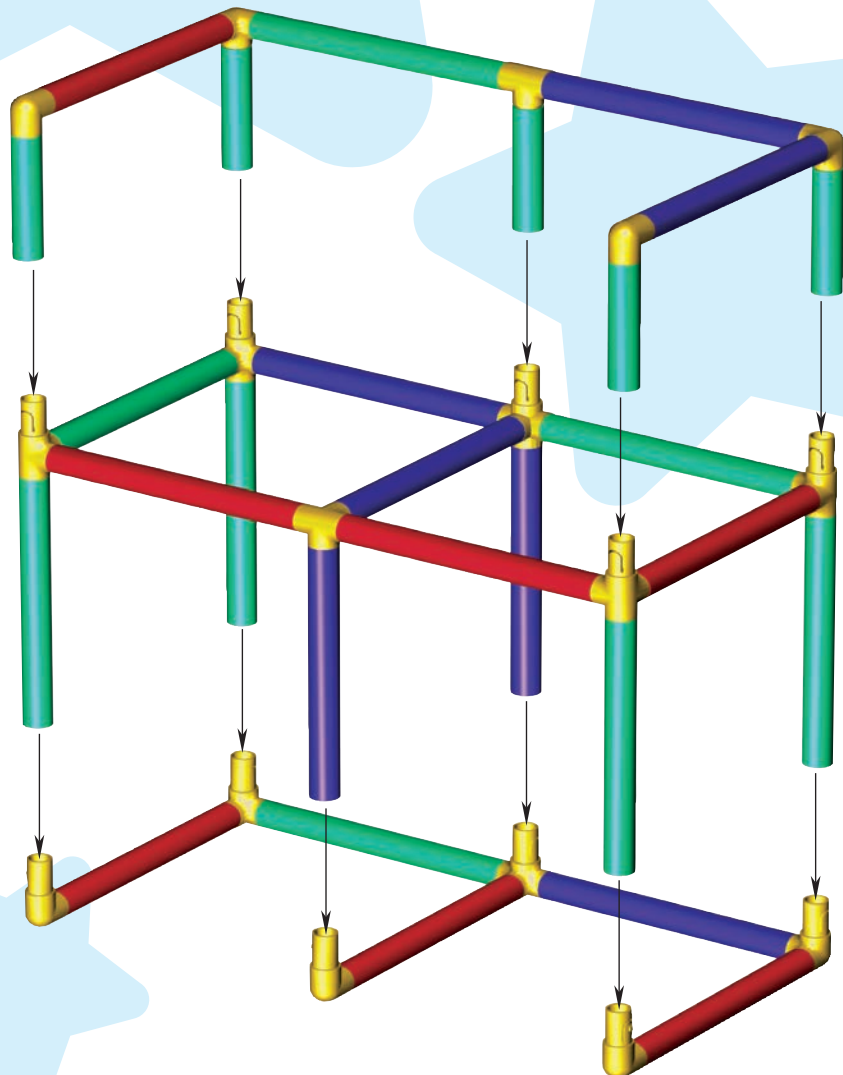

# ASSEMBLY ILLUSTRATION

1

A x2

B x2

C x1

Tube (143mm / Green) x5

Tube (300mm / Red) x1

Tube (300mm / Blue) x2

Tube (300mm / Green) x1

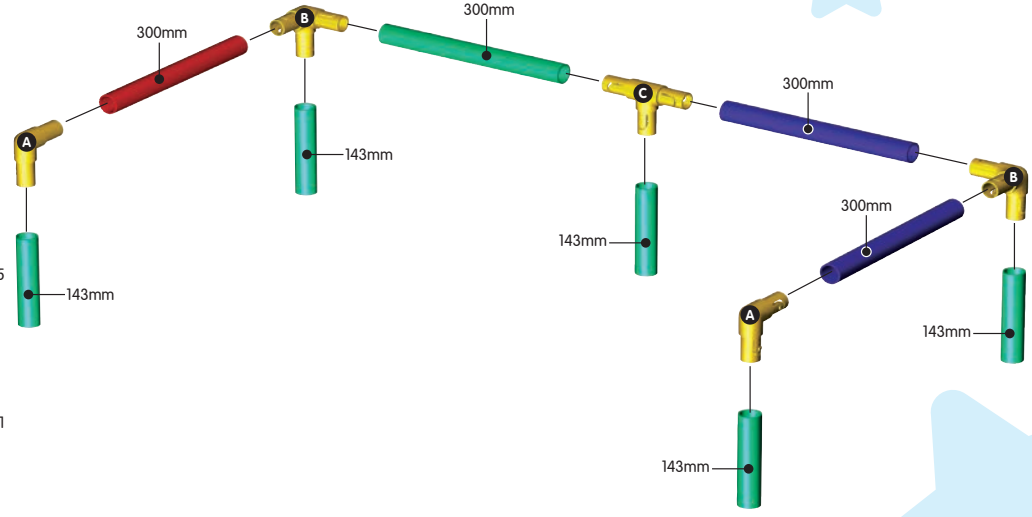

2

D x5

F x1

Tube (300mm / Red) x3

Tube (300mm / Blue) x4

Tube (300mm / Green) x6

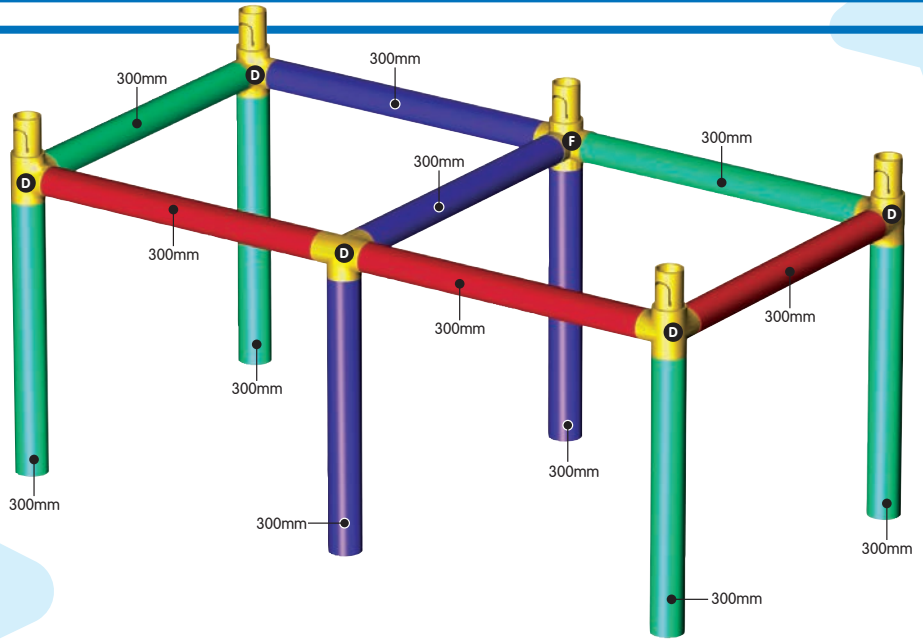

3

A x3

B x2

D x1

Tube (300mm / Red) x3

Tube (300mm / Blue) x1

Tube (300mm / Green) x1

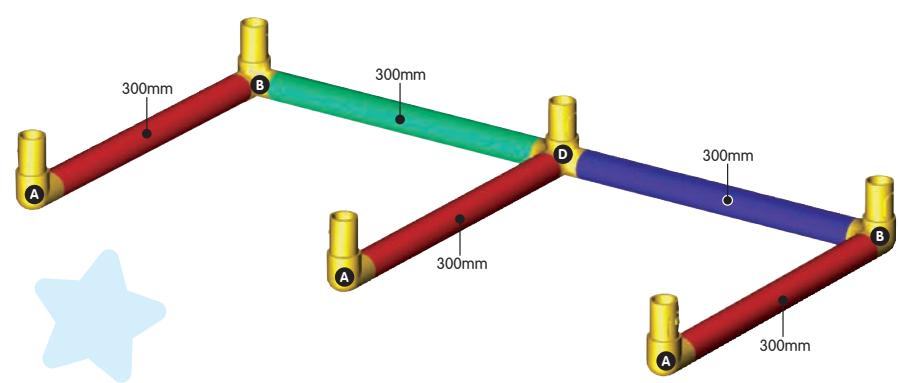

# #1139 ASSEMBLY ILLUSTRATION

## Furniture 3

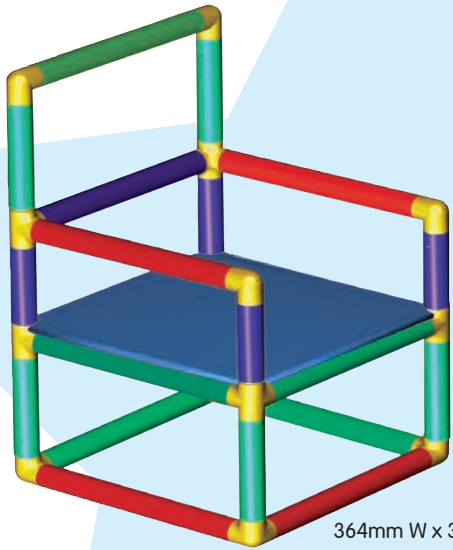

364mm W x 364mm D x 559mm H

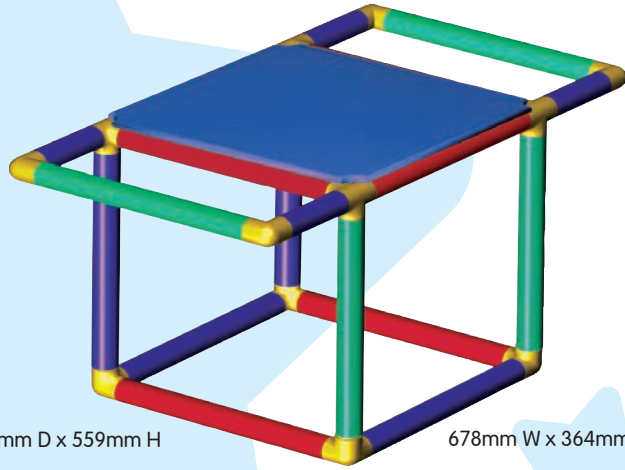

678mm W x 364mm D x 364mm H

COMPLETED

3

4

5

6

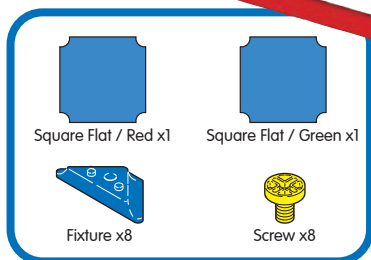

1



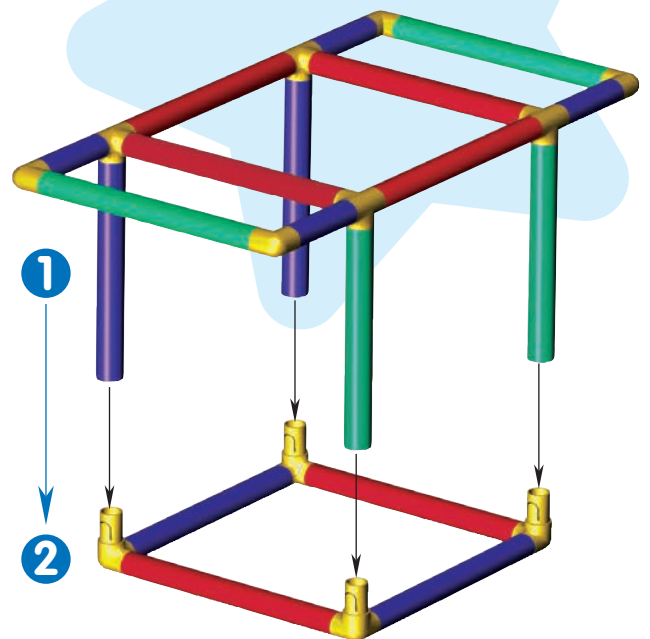



2





# ASSEMBLY ILLUSTRATION

1

- A**  x4
- D**  x4
-  Tube (105mm / Blue) x4
-  Tube (300mm / Red) x4
-  Tube (300mm / Blue) x2
-  Tube (300mm / Green) x4

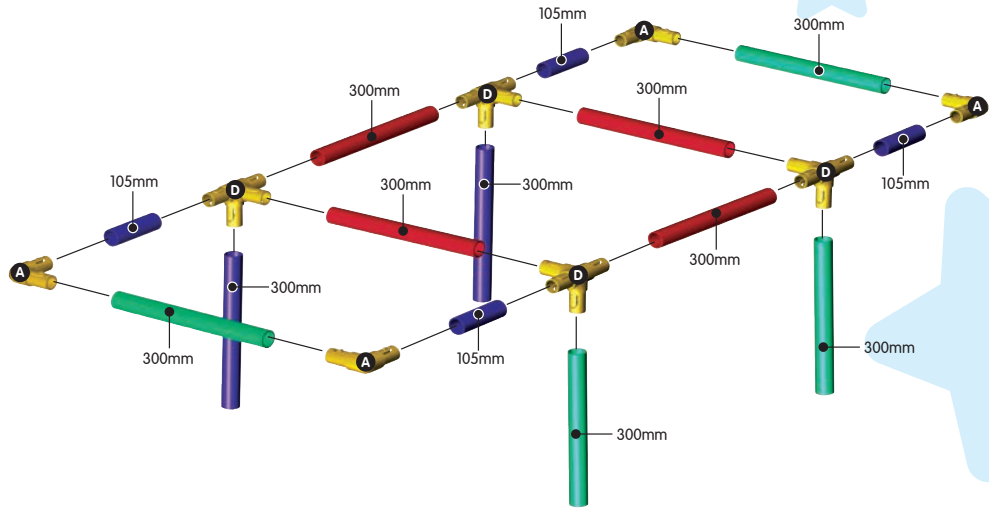

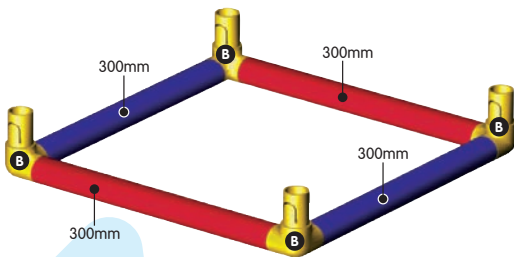

2

- B**  x4
-  Tube (300mm / Red) x2
-  Tube (300mm / Blue) x2





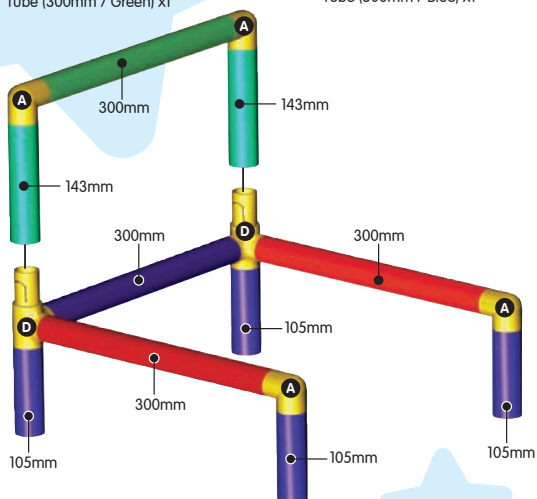

3

- A**  x2
-  Tube (143mm / Green) x2
-  Tube (300mm / Green) x1



4



- A**  x2
- D**  x2
-  Tube (105mm / Blue) x4
-  Tube (300mm / Red) x2
-  Tube (300mm / Blue) x1

5

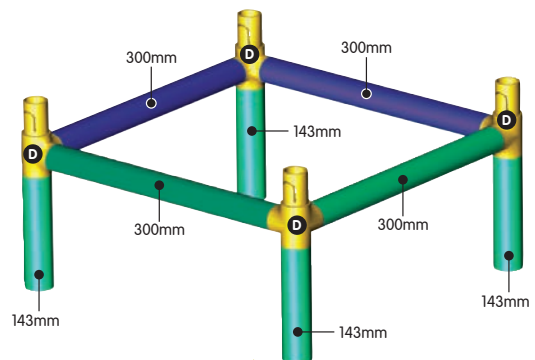
- D**  x4
-  Tube (143mm / Green) x4
-  Tube (300mm / Blue) x2
-  Tube (300mm / Green) x2



6

- B**  x4
-  Tube (300mm / Red) x2
-  Tube (300mm / Green) x2

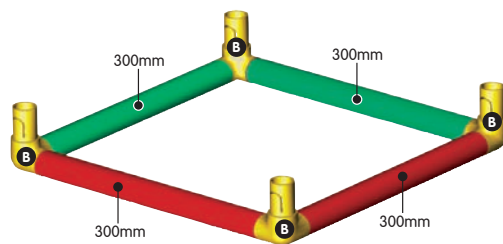

# #1139 ASSEMBLY ILLUSTRATION

## Furniture 4

COMPLETED

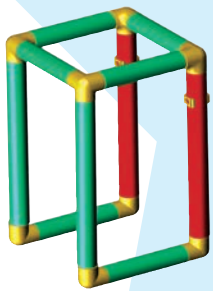

207mm W x 207mm D x 364mm H

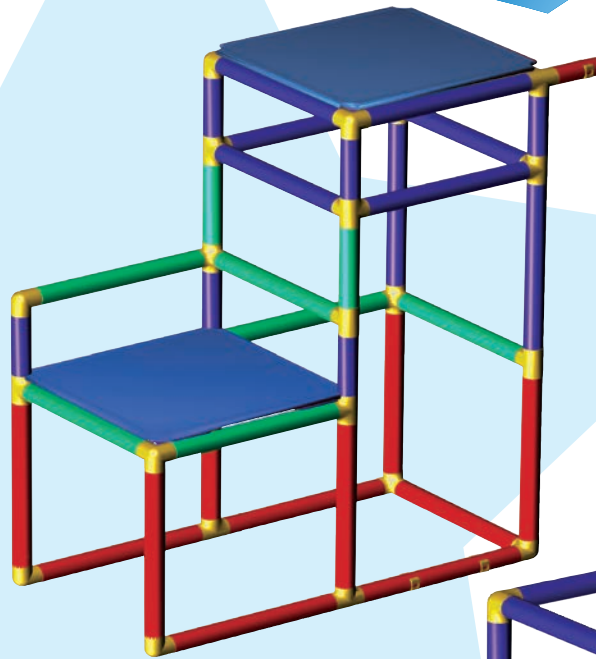

831mm W x 364mm D x 873mm H

6

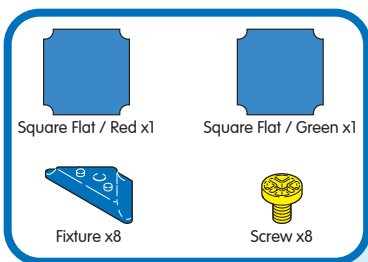
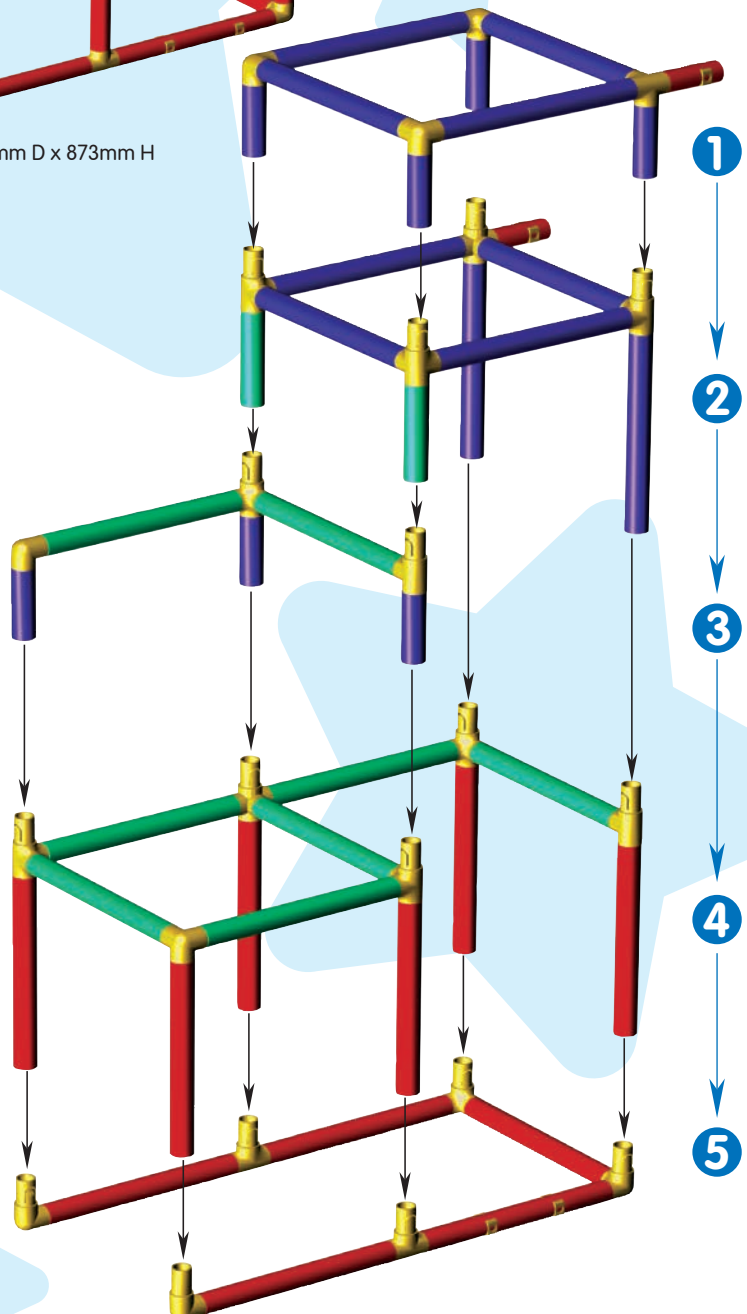
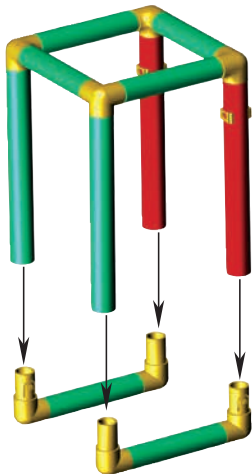

Square Flat / Red x1

Square Flat / Green x1

Fixture x8

Screw x8

# ASSEMBLY ILLUSTRATION

**1**

- B** x3
- D** x1
- Tube (105mm / Blue) x4
- Tube (300mm / Blue) x4
- Single Locking Tube (95mm / Red) X1

**2**

- D** x3
- F** x1
- Tube (143mm / Green) x2
- Tube (300mm / Blue) x6
- Single Locking Tube (95mm / Red) X1

**3**

- A** x1
- C** x1
- D** x1
- Tube (105mm / Blue) x3
- Tube (300mm / Green) x2

**4**

- B** x1
- C** x1
- D** x3
- F** x1
- Tube (300mm / Red) x6
- Tube (300mm / Green) x6

**6**

- A** x4
- B** x4
- Tube (143mm / Green) x6
- Tube (300mm / Green) x2
- Single Locking Tube (300mm / Red) X2

**5**

- A** x2
- B** x2
- C** x2
- Tube (300mm / Red) x4
- Double Locking Tube (300mm / Red) X1



**GENIUS TOY TAIWAN CO., LTD.**  
<http://www.gigo.com.tw> e-mail: [gigotoys@ms8.hinet.net](mailto:gigotoys@ms8.hinet.net)



**CE ST**

● U.S.A PAT. NO. 6413004 ● JAPAN PAT. NO. 3078464 ● TAIWAN PAT. NO. 167633