

## Features

- Rectangular basin with curved bottom.
- Overflow drain.

## Material

- Vitreous china.

## Installation

- No faucet holes; requires wall-or counter-mount faucet.
- Undermount.

## Recommended Products/Accessories

K-8998 P-Trap  
K-23726 Drain treatment  
K-23725 Cast iron cleaner

## Included Components

Additional Components:  
1193643 Basin clamps



ADA

## Codes/Standards











ASME A112.19.2/CSA B45.1  
ADA  
ICC/ANSI A117.1

## KOHLER® One-Year Limited Warranty

See website for detailed warranty information.

## Available Colors/Finishes

*Color tiles intended for reference only.*

Color	Code	Description
	0	White
	HW1	Honed White
	96	Biscuit
	47	Almond
	NY	Dune
	95	Ice™ Grey
	G9	Sandbar
	33	Mexican Sand™
	K4	Cashmere
	58	Thunder™ Grey
	7	Black Black™

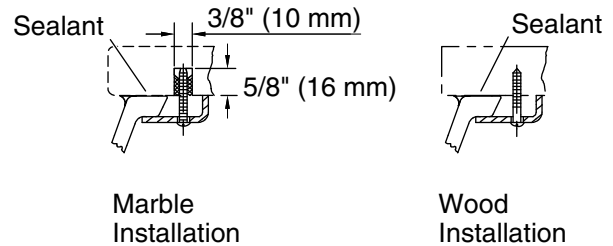
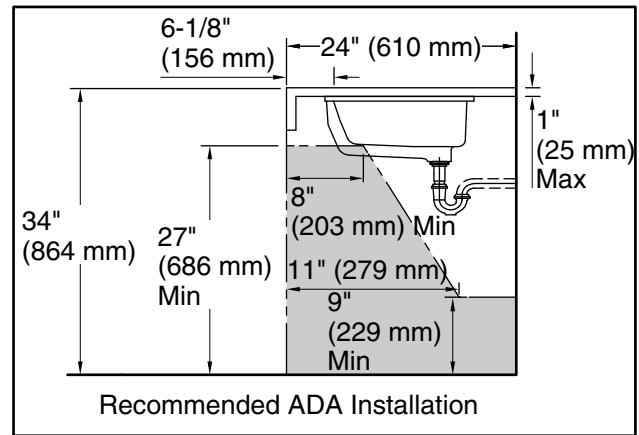
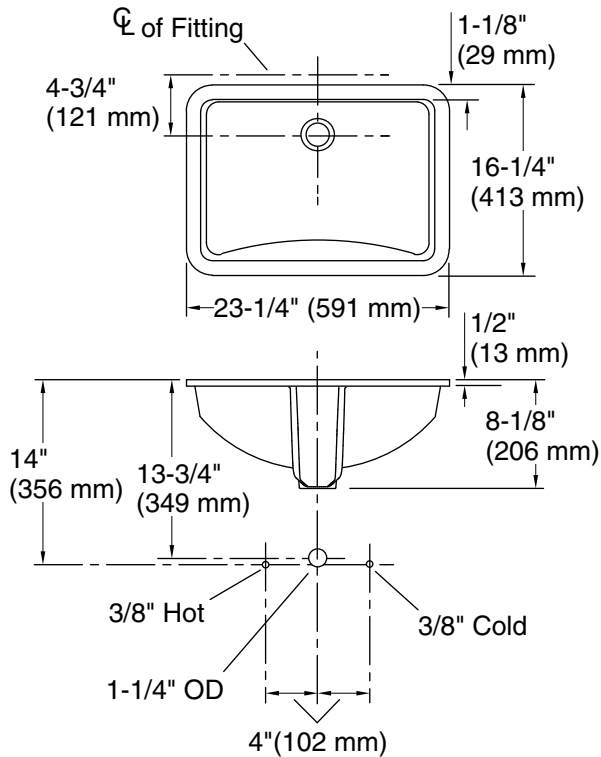

## Technical Information

All product dimensions are nominal.

Installation:	Under-mount
Bowl area:	Length: 20-5/8" (524 mm) Width: 13-5/8" (346 mm) Water depth: 4-5/8" (117 mm)
Drain hole:	1-3/4" (44 mm)
Template:	1002977-7, required, not included

## Notes

Install this product according to the installation instructions.

The product diagram is based on the K-8998 adjustable P-trap with 1" (25 mm) of tailpiece exposed.

**NOTICE:** Countertop manufacturer or cutter must use the current product template available at [www.kohler.com](http://www.kohler.com), or by calling 1-800-4KOHLER. Kohler Co. is not responsible for cutout errors when the incorrect cutout template is used.

ADA compliant when installed to the specific requirements of these regulations.