

Features

- Oval basin with unglazed underside.
- Overflow drain.
- Unglazed bottom of bowl.

Material

- Vitreous china.

Installation

- No faucet holes; requires wall-or counter-mount faucet.
- Undermount.

Recommended Products/Accessories

K-8998 P-Trap
K-23726 Drain treatment
K-23725 Cast iron cleaner

Included Components

Additional Components:
1193643 Basin clamps



ADA

Codes/Standards











ASME A112.19.2/CSA B45.1
ADA
ICC/ANSI A117.1

KOHLER® One-Year Limited Warranty

See website for detailed warranty information.

Available Colors/Finishes

Color tiles intended for reference only.

Color	Code	Description
	0	White
	96	Biscuit
	47	Almond
	NY	Dune
	55	Innocent Blush™
	95	Ice™ Grey
	G9	Sandbar
	33	Mexican Sand™
	K4	Cashmere
	58	Thunder™ Grey
	7	Black Black™

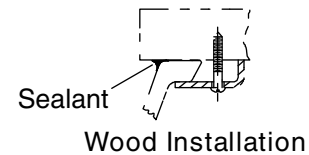
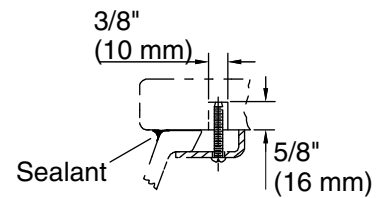
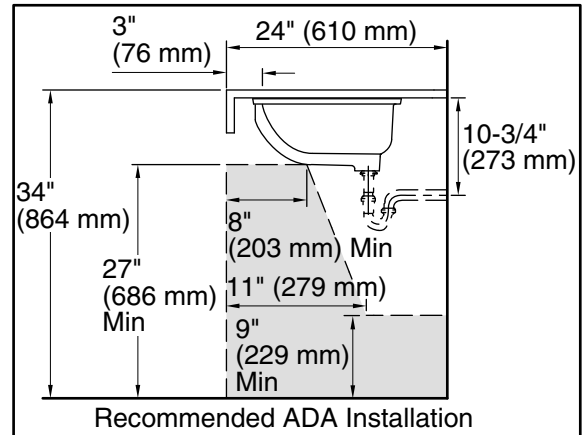
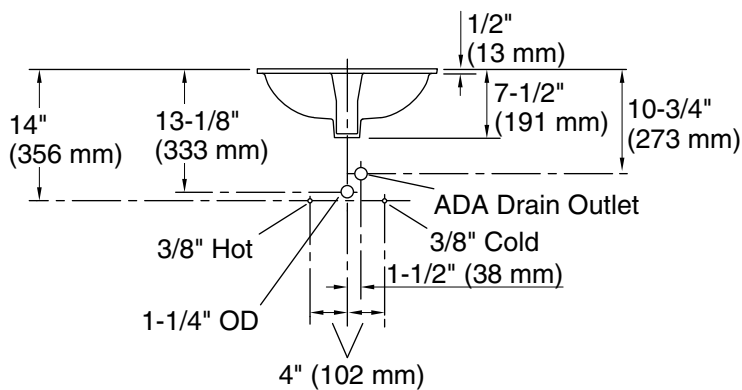
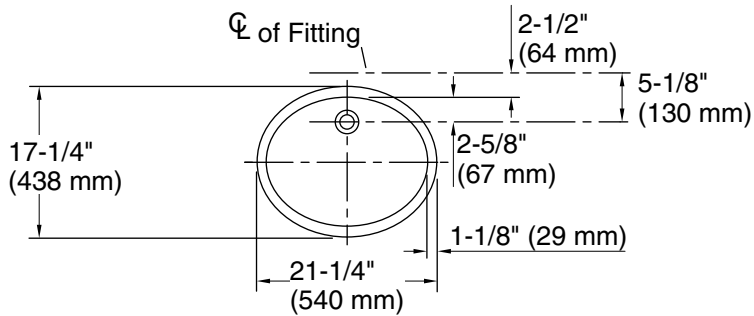

Technical Information

All product dimensions are nominal.

Installation:	Under-mount
Bowl area:	Length: 19" (483 mm) Width: 15" (381 mm) Water depth: 4" (102 mm)
Drain hole:	1-3/4" (44 mm)
Template:	1018997-7, required, not included

Notes

Install this product according to the installation instructions.

NOTICE: Countertop manufacturer or cutter must use the current product template available at www.kohler.com, or by calling 1-800-4KOHLER. Kohler Co. is not responsible for cutout errors when the incorrect cutout template is used.

ADA compliant when installed to the specific requirements of these regulations.