



CHARGit

INTELLIGENT WIRELESS CHARGING

Under Surface Long Distance 10W Wireless CHARGhub



Please read these instructions carefully before use

www.chargitstore.com hello@chargitstore.com 0333 700 8889

Component list

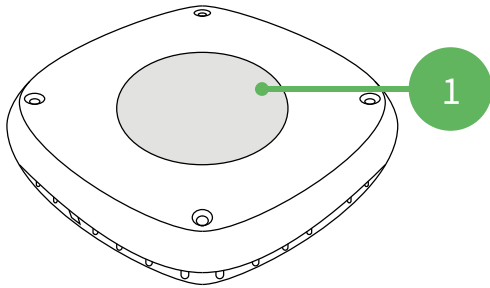

Wireless charger IC30 x1
pre-fitted with double
sided sticking pad

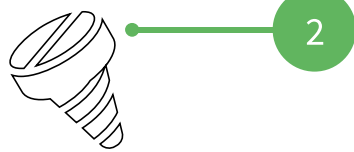

Anti-theft (optional)
fixing screws x4

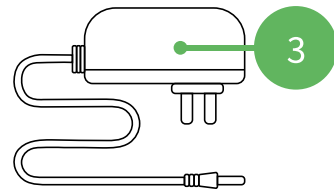

Power adapter x1

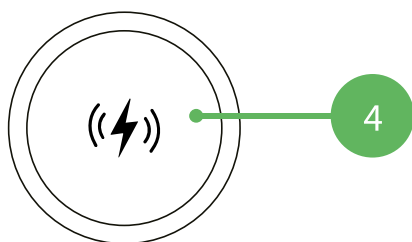

Marker sticker
(optional)

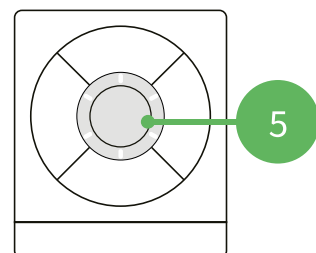

LED alignment
sensor x1

CHARGit Wireless Charger

The IC30 Invisible Wireless Charger is compatible with all Qi/ MagSafe devices

Charging distance can reach up to a maximum of 30mm*. Through wood, glass, acrylic, marble, granite and all other non-metallic surfaces.

WARNING: Please do not use through metal surfaces. Please do not place a device directly on to the charging unit, always keep a minimum distance of 15mm between the IC30 and the compatible Qi/MagSafe smartphone.

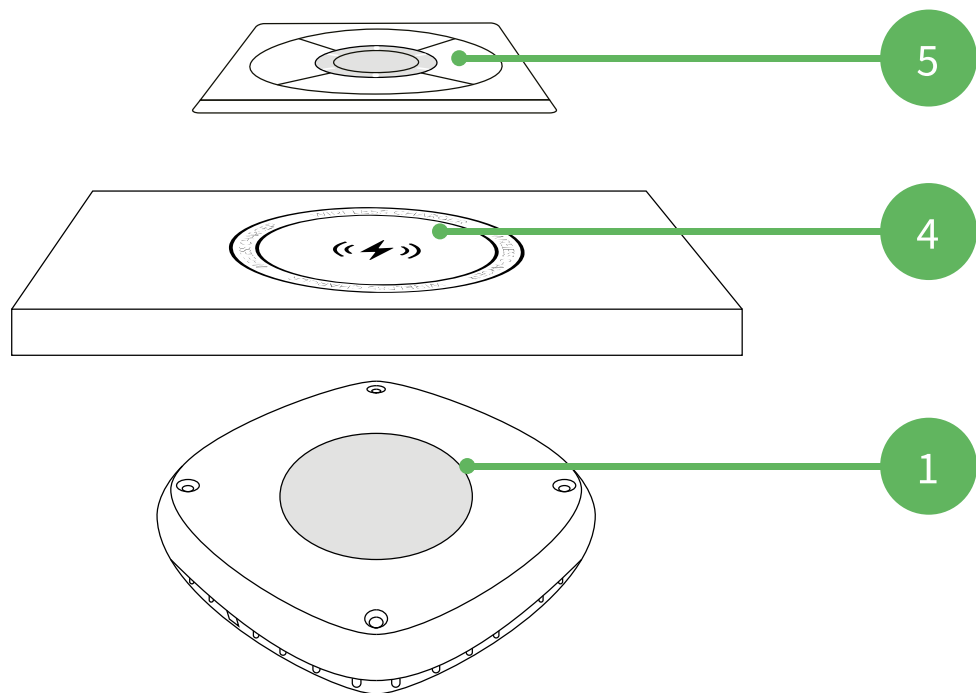

Installation steps

1. Select on your chosen surface where you would like to position your invisible charger. We suggest that you test that a compatible phone can charge through the surface before proceeding. **Please do not place device directly onto unit, always keep a minimum distance of 15mm.**
2. Plug the adaptor into the charger and attach the IC30 under the surface of your chosen location using the sticking pad and/or the anti theft screws.
3. Plug the power adaptor into the mains, a green light will indicate power is on.
4. If using a marker/sticker use the LED alignment sensor to identify the optimum location.
5. Place the LED sensor on top of the surface directly above the charger, move around until all 6 LED lights are illuminated. Lift the bottom section & remove the adhesive tape to stick in place. Lift & push out the round centre, lower back onto the surface and place your marker in the middle of the circle.
6. Place your device to charge, a solid green light will indicate it is charging.

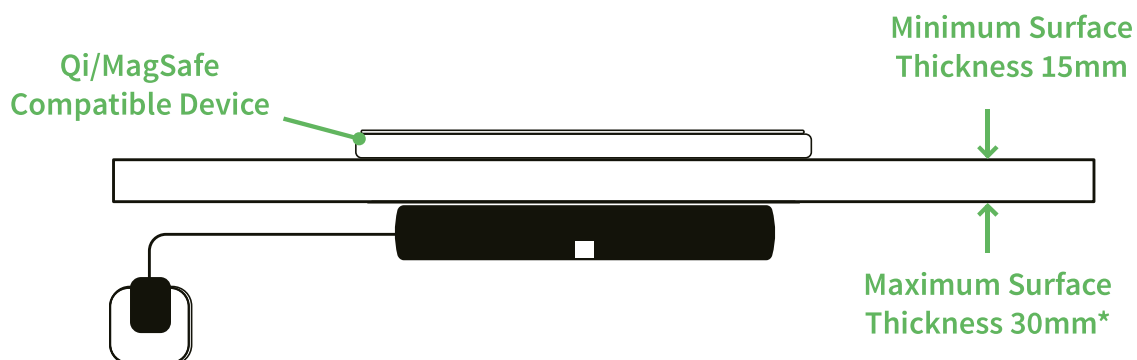

For surfaces thicker than 30mm*

For surfaces more than 30mm* thick we advise to route an area of 120 x 160mm.

*Whilst we state that the maximum distance is 30mm, please note that this can be exceeded when a device has a protective case on it. Therefore, if routing is an option, we would recommend that the depth between the IC30 Invisible Wireless Charger and the device is 25mm.

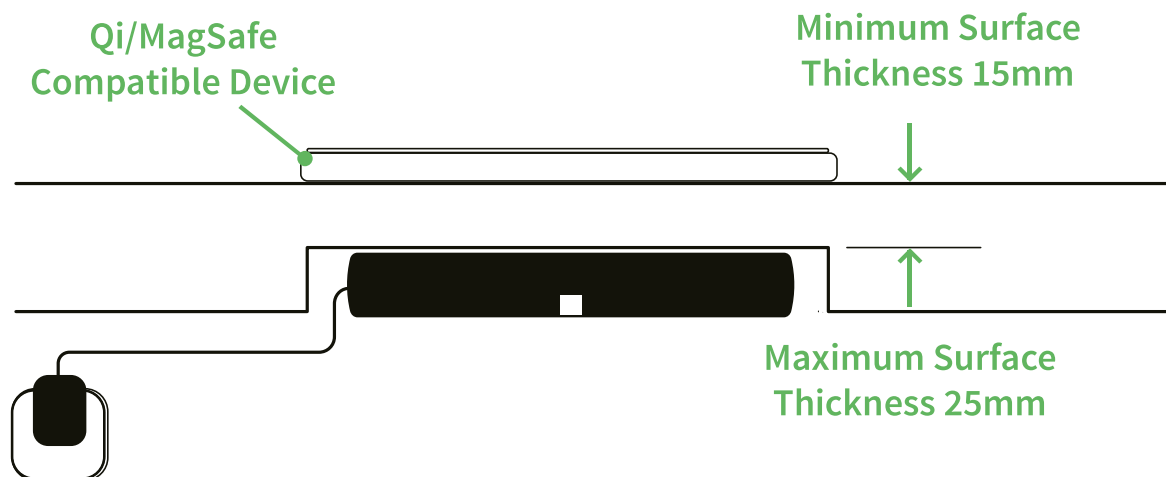

Power indicator lights

Power On	Orange light for a couple of seconds, then Red light
Stand-by	Red Light
Charging	Green Light
Abnormal (FOD)	Flashing

Warnings

1. Install the charger according to the instructions.
2. Do not install the charger under any metal object.
3. Do not place any metal objects or magnetic fields such as credit debit cards etc onto the charging area.
4. Keep away from humidity and heat.
5. Do not cover the fan when using.
6. Unplug this device when unused for long periods of time.
7. Disconnect the power before cleaning the charger.
8. Keep it beyond the reach of children.
9. Please always use the original power adapter.

Trouble shooting

If your device is not charging

1. Please ensure your device is compatible with Qi/MagSafe wireless charging.
2. Make sure your device is correctly aligned on the charging area.
3. Remove your case from your phone.
4. Ensure the charger is connected to power and switched on.
5. Allow 3-5 seconds between placing devices to charge.
6. Use the power cable supplied.
7. To reset the wireless charger, unplug from either the device or the mains, wait 30 seconds before powering back up.

Product specification

Model No.	CISIC30
Input	24V/1A
Wireless Output	Max 10W
Charging Distance	15-30mm
Charging Area	20mm
Working Frequency	125-135kHz
Dimensions	107 x 107 x 23mm
Protection	OTP, OVP, OCP
Material	ABS+PC
Weight	186g

The images in this manual are for illustration purposes only, the actual product may vary.

- In accordance with the FCC rules, this equipment has been tested and found to comply with the limits for a Class B digital devices. This equipment may cause interference to other equipment if not installed and used in accordance with these instructions.

Warranty

Your purchase includes 12 months warranty from the date of purchase.

Please call or email us for any further information,
hello@chargetstore.com 0333 700 8889.

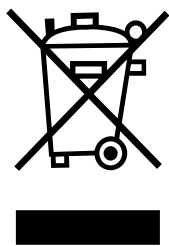

RoHS
compliant

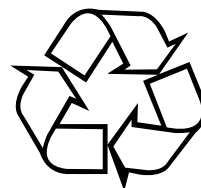



CHARGit
INTELLIGENT WIRELESS CHARGING

www.chargitstore.com

hello@chargitstore.com

0333 700 8889