

Product Data Sheet

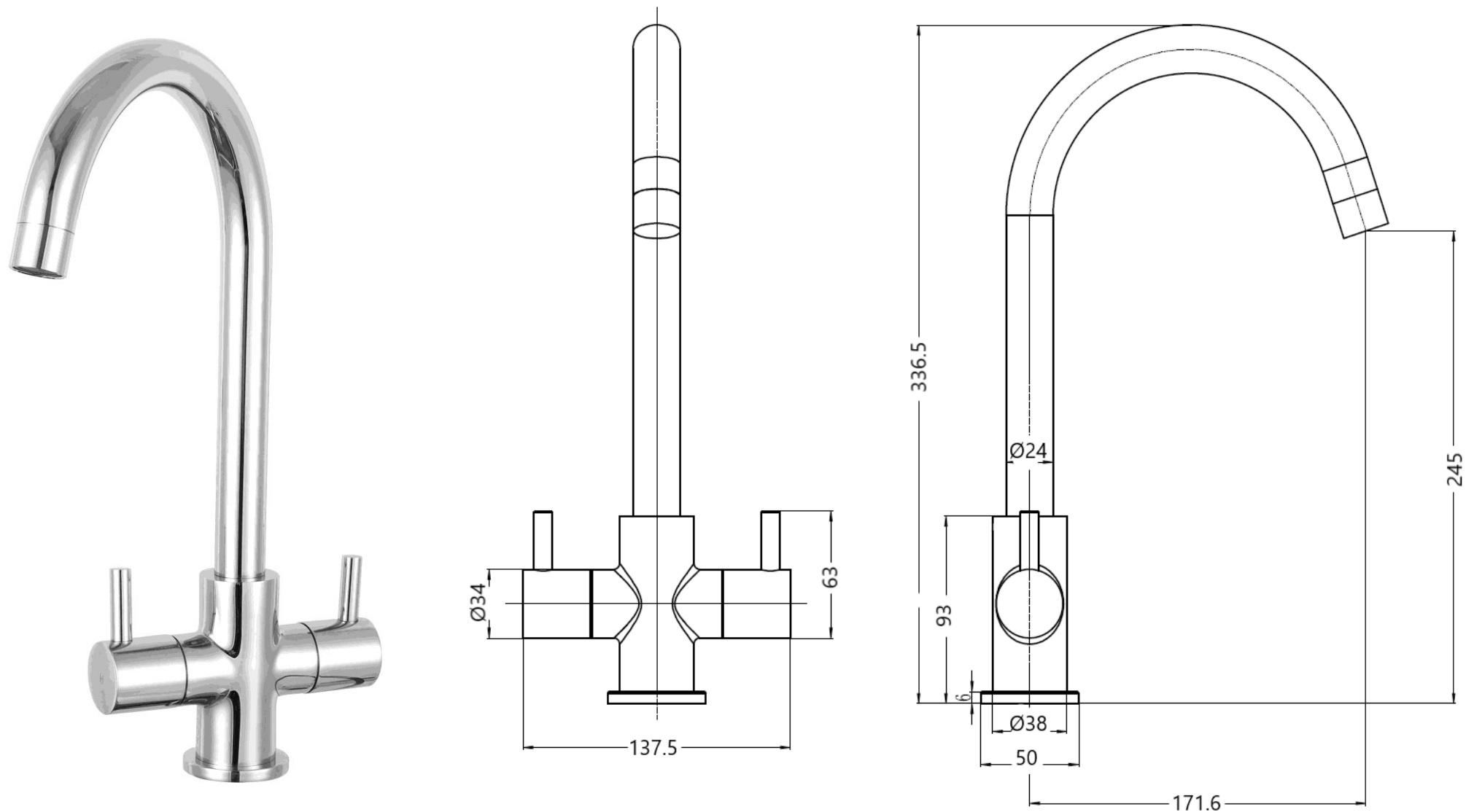

Prima Code	BPR2203
Description	Staten Dual Mixer Tap
Colour	Chrome
Material	Chrome
Minimum Pressure	0.5 bar
Maximum Pressure	6 bar
Spout Type	Swivel
Operation	Quarter turn
Spout Reach(mm)	171.6
Spout Height (mm)	245
Product Height (mm)	336.5
Base/Handle Width (mm)	137.5
Base Diameter (mm)	50
Tap Hole requirement (mm)	30
Guarantee	10 years
WRAS approved (/certificate)	NO