



User Manual
Oven

EN

KOFGH40TW
KOFGH40TX



electrolux.com/register

 **Electrolux**

Welcome to Electrolux! Thank you for choosing our appliance.



For Customer Care support, repair information and webshop visit:
www.electrolux.com/support



For extended version of User Manual visit:
www.electrolux.com/manuals

Subject to change without notice.

CONTENTS

1. SAFETY INFORMATION.....	2
2. SAFETY INSTRUCTIONS.....	4
3. INSTALLATION.....	6
4. PRODUCT DESCRIPTION.....	8
5. CONTROL PANEL.....	8
6. BEFORE FIRST USE.....	9
7. DAILY USE.....	9
8. CLOCK FUNCTIONS.....	10
9. USING THE ACCESSORIES.....	11
10. ADDITIONAL FUNCTIONS.....	13
11. HINTS AND TIPS.....	13
12. CARE AND CLEANING.....	21
13. TROUBLESHOOTING.....	23
14. ENERGY EFFICIENCY.....	24

1. ⚠ SAFETY INFORMATION

Before the installation and use of the appliance, carefully read the supplied instructions. The manufacturer is not responsible for any injuries or damage that are the result of incorrect installation or usage. Always keep the instructions in a safe and accessible location for future reference.

1.1 Children and vulnerable people safety

- This appliance can be used by children aged from 8 years and above and persons with reduced physical, sensory or mental capabilities or lack of experience and knowledge if they have been given supervision or instruction concerning the use of the appliance in a safe way and understand the hazards involved. Children of less than 8 years of age and persons with very extensive and complex disabilities shall

be kept away from the appliance unless continuously supervised.

- Do not let children play with the appliance.
- Keep all packaging away from children and dispose of it appropriately.
- **WARNING:** Keep children and pets away from the appliance when it operates or when it cools down. Accessible parts become hot during use.
- If the appliance has a child safety device, it should be activated.
- Children shall not carry out cleaning and user maintenance of the appliance without supervision.

1.2 General Safety

- Only a qualified person must install this appliance and replace the cable.
- **WARNING:** The appliance and its accessible parts become hot during use. Care should be taken to avoid touching heating elements.
- Always use oven gloves to remove or put in accessories or ovenware.
- Before carrying out any maintenance, disconnect the appliance from the power supply.
- **WARNING:** Ensure that the appliance is switched off before replacing the lamp to avoid the possibility of electric shock.
- Do not use the appliance before installing it in the built-in structure.
- Do not use a steam cleaner to clean the appliance.
- Do not use harsh abrasive cleaners or sharp metal scrapers to clean the glass door since they can scratch the surface, which may result in shattering of the glass.
- If the mains power supply cable is damaged, it must be replaced by the manufacturer, its Authorised Service Centre or similarly qualified persons to avoid an electrical hazard.
- To remove the shelf supports first pull the front of the shelf support and then the rear end away from the side walls. Install the shelf supports in the opposite sequence.

- The means for disconnection must be incorporated in the fixed wiring in accordance with the wiring rules.

2. SAFETY INSTRUCTIONS

2.1 Installation



WARNING!

Only a qualified person must install this appliance.

- Remove all the packaging.
- Do not install or use a damaged appliance.
- Follow the installation instructions supplied with the appliance.
- Always take care when moving the appliance as it is heavy. Always use safety gloves and enclosed footwear.
- Do not pull the appliance by the handle.
- Install the appliance in a safe and suitable place that meets installation requirements.
- Keep the minimum distance from other appliances and units.
- Before mounting the appliance, check if the oven door opens without restraint.
- The appliance is equipped with an electric cooling system. It must be operated with the electric power supply.

Cabinet minimum height (Cabinet under the worktop minimum height)	590 (600) mm
---	--------------

Cabinet width	560 mm
---------------	--------

Cabinet depth	550 (550) mm
---------------	--------------

Height of the front of the appliance	594 mm
---	--------

Height of the back of the appliance	576 mm
--	--------

Width of the front of the ap- pliance	595 mm
--	--------

Width of the back of the appliance	559 mm
---------------------------------------	--------

Depth of the appliance	569 mm
------------------------	--------

Built in depth of the appli- ance	548 mm
--------------------------------------	--------

Depth with open door	1022 mm
----------------------	---------

Ventilation opening mini- mum size. Opening placed on the bottom rear side	560x20 mm
--	-----------

Mounting screws

4x25 mm

2.2 Electrical connection



WARNING!

Risk of fire and electric shock.

- All electrical connections should be made by a qualified electrician.
- The appliance must be earthed.
- Make sure that the parameters on the rating plate are compatible with the electrical ratings of the mains power supply.
- Always use a correctly installed shockproof socket.
- Do not use multi-plug adapters and extension cables.
- Make sure not to cause damage to the mains plug and to the mains cable. Should the mains cable need to be replaced, this must be carried out by our Authorised Service Centre.
- Do not let mains cables touch or come near the appliance door or the niche below the appliance, especially when it operates or the door is hot.
- The shock protection of live and insulated parts must be fastened in such a way that it cannot be removed without tools.
- Connect the mains plug to the mains socket only at the end of the installation. Make sure that there is access to the mains plug after the installation.
- If the mains socket is loose, do not connect the mains plug.
- Do not pull the mains cable to disconnect the appliance. Always pull the mains plug.
- Use only correct isolation devices: line protecting cut-outs, fuses (screw type fuses removed from the holder), earth leakage trips and contactors.
- The electrical installation must have an isolation device which lets you disconnect the appliance from the mains at all poles. The isolation device must have a contact opening width of minimum 3 mm.

- This appliance is supplied without a main plug and a main cable.

Cable types applicable for installation or replacement for Europe:

H07 RN-F, H05 RN-F, H05 RRF, H05 VV-F, H05 V2V2-F (T90), H05 BB-F

For the section of the cable refer to the total power on the rating plate. You can also refer to the table:

Total power (W)	Section of the cable (mm ²)
maximum 1380	3 x 0.75
maximum 2300	3 x 1
maximum 3680	3 x 1.5

The earth cord (green / yellow cable) must be 2 cm longer than phase and neutral cables (blue and brown cables).

Cable types applicable for installation or replacement for UK only

Connection via	Min. size cable / flex	Cable / flex type / Fuse
Oven Control Circuit	2,5 mm ²	PVC / PVC twin and earth / 15 A min. PVC / PVC twin and earth / 20 A max.

2.3 Use



WARNING!

Risk of injury, burns and electric shock or explosion.

- This appliance is for household use only.
- Do not change the specification of this appliance.
- Make sure that the ventilation openings are not blocked.
- Do not let the appliance stay unattended during operation.
- Deactivate the appliance after each use.
- Be careful when you open the appliance door while the appliance is in operation. Hot air can release.
- Do not operate the appliance with wet hands or when it has contact with water.
- Do not apply pressure on the open door.

- Do not use the appliance as a work surface or as a storage surface.
- Open the appliance door carefully. The use of ingredients with alcohol can cause a mixture of alcohol and air.
- Do not let sparks or open flames to come in contact with the appliance when you open the door.
- Do not put flammable products or items that are wet with flammable products in, near or on the appliance.



WARNING!

Risk of damage to the appliance.

- To prevent damage or discoloration to the enamel:
 - do not put ovenware or other objects in the appliance directly on the bottom.
 - do not put aluminium foil directly on the bottom of cavity of the appliance.
 - do not put water directly into the hot appliance.
 - do not keep moist dishes and food in the appliance after you finish the cooking.
 - be careful when you remove or install the accessories.
- Discoloration of the enamel or stainless steel has no effect on the performance of the appliance.
- Use a deep pan for moist cakes. Fruit juices cause stains that can be permanent.
- This appliance is for cooking purposes only. It must not be used for other purposes, for example room heating.
- Always cook with the oven door closed.
- If the appliance is installed behind a furniture panel (e.g. a door) make sure the door is never closed when the appliance operates. Heat and moisture can build up behind a closed furniture panel and cause subsequent damage to the appliance, the housing unit or the floor. Do not close the furniture panel until the appliance has cooled down completely after use.

2.4 Care and cleaning



WARNING!

Risk of injury, fire, or damage to the appliance.

- Before maintenance, deactivate the appliance and disconnect the mains plug from the mains socket.
- Make sure the appliance is cold. There is the risk that the glass panels can break.
- Replace immediately the door glass panels when they are damaged. Contact the Authorised Service Centre.
- Be careful when you remove the door from the appliance. The door is heavy!
- Clean regularly the appliance to prevent the deterioration of the surface material.
- Clean the appliance with a moist soft cloth. Use only neutral detergents. Do not use abrasive products, abrasive cleaning pads, solvents or metal objects.
- If you use an oven spray, follow the safety instructions on its packaging.

2.5 Internal lighting



WARNING!

Risk of electric shock.

- Concerning the lamp(s) inside this product and spare part lamps sold separately: These lamps are intended to withstand extreme physical conditions in household

appliances, such as temperature, vibration, humidity, or are intended to signal information about the operational status of the appliance. They are not intended to be used in other applications and are not suitable for household room illumination.

- Use only lamps with the same specifications.

2.6 Service

- To repair the appliance contact the Authorised Service Centre.
- Use original spare parts only.

2.7 Disposal



WARNING!

Risk of injury or suffocation.

- Disconnect the appliance from the mains supply.
- Cut off the mains electrical cable close to the appliance and dispose of it.
- Remove the door catch to prevent children or pets from becoming trapped in the appliance.

3. INSTALLATION



WARNING!

Refer to Safety chapters.

3.1 Building in



www.youtube.com/electrolux
www.youtube.com/aeg

How to install your AEG/Electrolux
Oven - Column installation



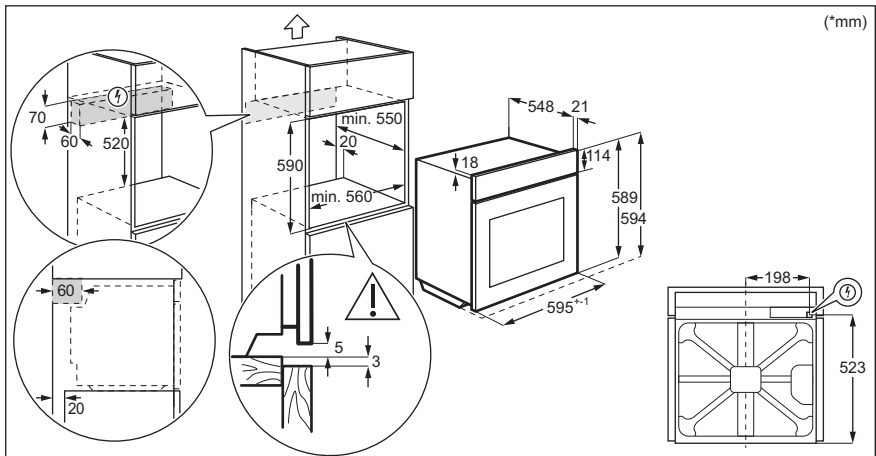
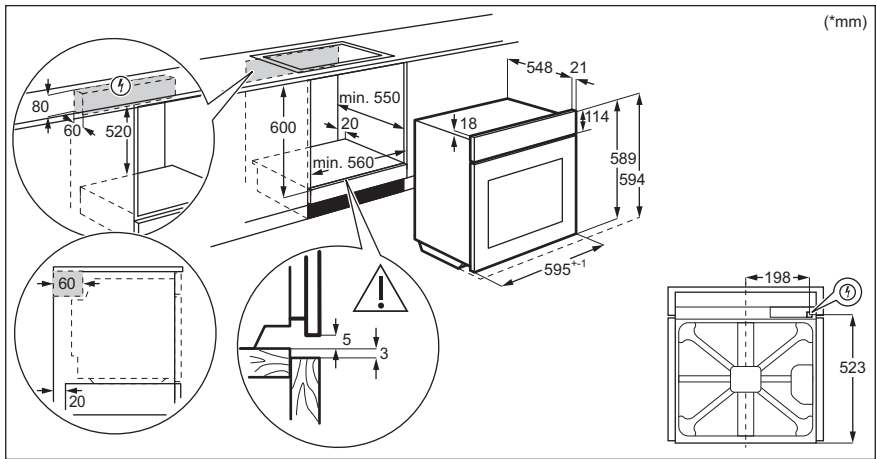

3.2 Securing the oven to the cabinet

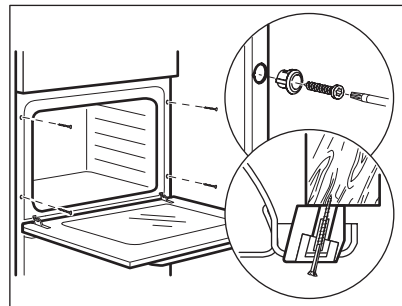

4. PRODUCT DESCRIPTION

4.1 General overview

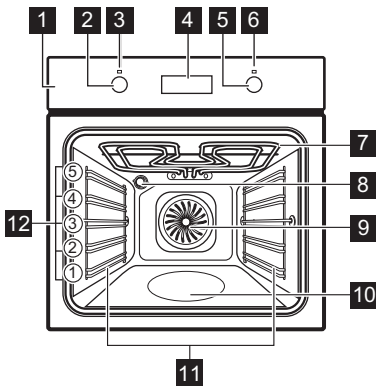

- 1 Control panel
- 2 Knob for the heating functions
- 3 Power lamp / symbol
- 4 Display
- 5 Control knob (for the temperature)
- 6 Temperature indicator / symbol
- 7 Heating element
- 8 Lamp
- 9 Fan
- 10 Cavity embossment - Aqua cleaning container
- 11 Shelf support, removable
- 12 Shelf positions

4.2 Accessories

- **Wire shelf**
For cookware, cake tins, roasts.
- **Grill- / Roasting pan**
To bake and roast or as pan to collect fat.

• Trivet

For roasting and grilling.



Use the trivet only with the Grill- / roasting pan.

5. CONTROL PANEL

5.1 Retractable knobs

To use the appliance press the knob. The knob comes out.

5.2 Sensor fields / Buttons

—	To set the time.
⌚	To set a clock function.
+	To set the time.

5.3 Display

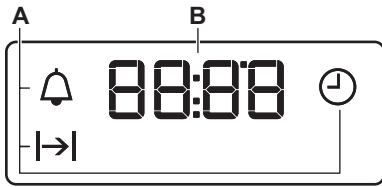

- A. Clock functions
- B. Timer

6. BEFORE FIRST USE



WARNING!

Refer to Safety chapters.

6.1 Before first use

The oven can emit an odour and smoke during preheating. Make sure that the room is ventilated.



Step 1

Set the clock

1. Press:
2. - press to set the hour.
Press:
3. - press to set the minutes. Press:



Step 2

Clean the oven

1. Remove all accessories and removable shelf supports from the oven.
2. Clean the oven and the accessories with a soft cloth, warm water and a mild detergent.



Step 3

Preheat the empty oven

1. Set the maximum temperature for the function:
- Time: 1 h.
2. Set the maximum temperature for the function:
- Time: 15 min.
3. Set the maximum temperature for the function:
- Time: 15 min.

Turn off the oven and wait until it is cold. Place the accessories and the removable shelf supports in the oven.

7. DAILY USE



WARNING!

Refer to Safety chapters.







7.1 How to set: Heating function



- Step 1** Turn the knob for the heating functions to select a heating function.

- Step 2** Turn the control knob to select the temperature.

- Step 3** When the cooking ends, turn the knobs to the off position to turn off the oven.

7.2 Heating functions

Heating function	Application
 Off position	The oven is off.
 Light	To turn on the lamp.
 True Fan Cooking	To bake on up to three shelf positions at the same time and to dry food. Set the temperature 20 - 40 °C lower than for Conventional Cooking.
 Moist Fan Baking	This function is designed to save energy during cooking. When you use this function, the temperature in the cavity may differ from the set temperature. The heating power may be reduced. For more information refer to "Daily Use" chapter, Notes on: Moist Fan Baking.
 Bottom Heat	To bake cakes with crispy bottom and to preserve food.
 Grill	To grill thin pieces of food and to toast bread.
 Fast Grilling	To grill thin pieces of food in large quantities and to toast bread.

Heating function	Application
 Turbo Grilling	To roast large meat joints or poultry with bones on one shelf position. To make gratins and to brown.
 Pizza Function	To bake pizza. To make intensive browning and a crispy bottom.
 Conventional Cooking / Aqua Clean	To bake and roast food on one shelf position. Refer to "Care and cleaning" chapter for more information about: Aqua Clean.

7.3 Notes on: Moist Fan Baking



This function was used to comply with the energy efficiency class and ecodesign requirements according to EU 65/2014 and EU 66/2014. Tests according to EN 60350-1.

The oven door should be closed during cooking so that the function is not interrupted and the oven operates with the highest energy efficiency possible.

For the cooking instructions refer to "Hints and tips" chapter, Moist Fan Baking. For general energy saving recommendations refer to "Energy Efficiency" chapter, Energy Saving.

8. CLOCK FUNCTIONS

8.1 Clock functions



Clock function	Application
 Time of Day	To set, change or check the time of day.
 Duration	To set how long the oven works.
 Minute Minder	To set a countdown. This function has no effect on the operation of the oven. You can set this function at any time, also when the oven is off.



8.2 How to set: Clock functions

How to change: Time of Day

 - flashes when you connect the oven to the electrical supply, when there was a power cut or when the timer is not set.



Step 1  - press repeatedly.  - starts to flash.





Step 2  ,  - press to set the time.
After approximately 5 sec., the flashing stops and the display shows the time.

 - press repeatedly to change the time of day.  - starts to flash.

How to set: Duration

Step 1 Set an oven function and the temperature.

Step 2  - press repeatedly.  - starts to flash.



Step 3  ,  - press to set the duration.
The display shows: .
 - flashes when the set time ends. The signal sounds and the oven turns off.

Step 4 Press any button to stop the signal.

Step 5 Turn the knobs to the off position.

How to set: Minute Minder

Step 1  - press repeatedly.  - starts to flash.

Step 2  ,  - press to set the time.
The function starts automatically after 5 sec.
When the set time ends, the signal sounds.

Step 3 Press any button to stop the signal.

Step 4 Turn the knobs to the off position.

How to cancel: Clock functions

Step 1  - press repeatedly until the clock function symbol starts to flash.

Step 2 Press and hold: .
The clock function turns off after few seconds.

9. USING THE ACCESSORIES



WARNING!

Refer to Safety chapters.

A small indentation at the top increases safety. The indentations are also anti-tip devices. The high rim around the shelf prevents cookware from slipping of the shelf.

9.1 Inserting accessories

Wire shelf:

Push the shelf between the guide bars of the shelf support and make sure that the feet point down.

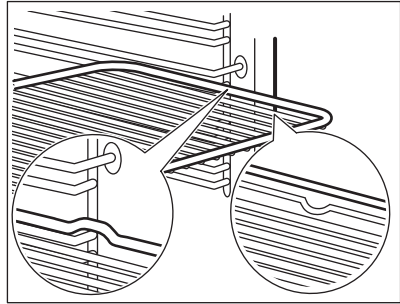

Deep pan:

Push the tray between the guide bars of the shelf support.

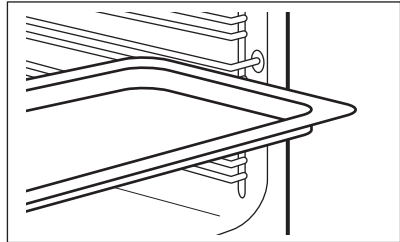

Wire shelf, Deep pan:

Push the tray between the guide bars of the shelf support and the wire shelf on the guide bars above.

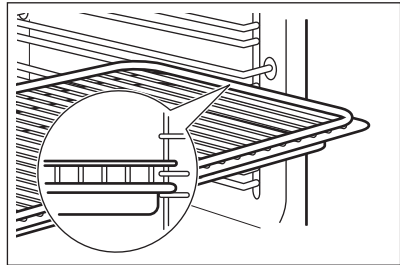

9.2 Trivet and Grill- / Roasting pan

Step 1 Put the trivet into a deep pan.

Step 2 Put the deep pan on the recommended shelf position.

Roasting larger pieces of meat or poultry on one shelf position.

Grilling and toasting thin pieces of food in large quantities.

Make sure the supports of the wire shelf point up.

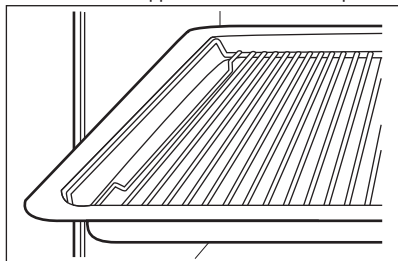

Make sure the supports of the wire shelf point down.

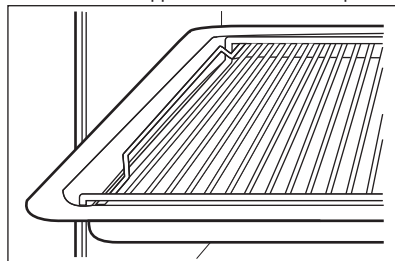

10. ADDITIONAL FUNCTIONS

10.1 Cooling fan

When the oven operates, the cooling fan turns on automatically to keep the surfaces of the oven cool. If you turn off the oven, the cooling fan can continue to operate until the oven cools down.

10.2 Safety thermostat

Incorrect operation of the oven or defective components can cause dangerous overheating. To prevent this, the oven has a safety thermostat which interrupts the power supply. The oven turns on again automatically when the temperature drops.

11. HINTS AND TIPS



WARNING!

Refer to Safety chapters.

11.1 Cooking recommendations

The oven has five shelf positions.

Count the shelf positions from the bottom of the oven floor.

Your oven may bake or roast differently to the oven you had before. The below tables provide you with the standard settings for temperature, cooking time and shelf position.

If you cannot find the settings for a special recipe, look for the similar one.

The oven has a special system which circulates the air and constantly recycles the steam. With this system you can cook in a steamy environment and keep the food soft inside and crusty outside. It decreases the cooking time and energy consumption.

Baking cakes

Do not open the oven door before 3/4 of the set cooking time is up.

If you use two baking trays at the same time, keep one empty level between them.

Cooking meat and fish

Use a deep pan for very fatty food to prevent the oven from stains that can be permanent.

Leave the meat for approximately 15 minutes before carving so that the juice does not seep out.







To prevent too much smoke in the oven during roasting, add some water into the deep pan. To prevent the smoke condensation, add water each time after it dries up.

Cooking times







Cooking times depend on the type of food, its consistency, and volume.

Initially, monitor the performance when you cook. Find the best settings (heat setting, cooking time, etc.) for your cookware, recipes and quantities when you use this appliance.

11.2 Baking and roasting







 CAKES	Conventional Cooking		True Fan Cooking		 (min)	
	 (°C)		 (°C)			
Whisked recipes	170	2	160	3 (2 and 4)	45 - 60	Cake mould
Shortbread dough	170	2	160	3 (2 and 4)	20 - 30	Cake mould
Buttermilk cheese-cake	170	1	165	2	60 - 80	Cake mould, Ø 26 cm
Strudel	175	3	150	2	60 - 80	Baking tray
Jam tart	170	2	165	2	30 - 40	Cake mould, Ø 26 cm
Christmas cake, preheat the empty oven	160	2	150	2	90 - 120	Cake mould, Ø 20 cm
Plum cake, pre-heat the empty oven	175	1	160	2	50 - 60	Bread tin
Muffins	170	3	140 - 150	3	20 - 30	Baking tray
Muffins, two levels	-	-	140 - 150	2 and 4	25 - 35	Baking tray
Muffins, three levels	-	-	140 - 150	1, 3 and 5	30 - 45	Baking tray
Biscuits	140	3	140 - 150	3	30 - 35	Baking tray
Biscuits, two levels	-	-	140 - 150	2 and 4	35 - 40	Baking tray
Biscuits, three levels	-	-	140 - 150	1, 3 and 5	35 - 45	Baking tray
Meringues	120	3	120	3	80 - 100	Baking tray
Meringues, two levels, preheat the empty oven	-	-	120	2 and 4	80 - 100	Baking tray
Buns, preheat the empty oven	190	3	190	3	12 - 20	Baking tray
Eclairs	190	3	170	3	25 - 35	Baking tray
Eclairs, two levels	-	-	170	2 and 4	35 - 45	Baking tray
Plate tarts	180	2	170	2	45 - 70	Cake mould, Ø 20 cm
Rich fruit cake	160	1	150	2	110 - 120	Cake mould, Ø 24 cm

Preheat the empty oven.

 BREAD AND PIZZA	Conventional Cooking		True Fan Cooking		 (min)	
	 (°C)		 (°C)			
White bread, 1 - 2 pieces, 0.5 kg each	190	1	190	1	60 - 70	-
Rye bread, preheating is not needed	190	1	180	1	30 - 45	Bread tin
Bread rolls, 6 - 8 rolls	190	2	180	2 (2 and 4)	25 - 40	Baking tray
Pizza	230 - 250	1	230 - 250	1	10 - 20	Enamelled tray
Scones	200	3	190	3	10 - 20	Baking tray





Preheat the empty oven.





Use the cake mould.







 FLANS	Conventional Cooking		True Fan Cooking		 (min)
	 (°C)		 (°C)		
Pasta flan, preheating is not needed	200	2	180	2	40 - 50
Vegetable flan, preheating is not needed	200	2	175	2	45 - 60
Quiches	180	1	180	1	50 - 60
Lasagne	180 - 190	2	180 - 190	2	25 - 40
Cannelloni	180 - 190	2	180 - 190	2	25 - 40

Use the second shelf position.





Use the wire shelf.

 MEAT	Conventional Cooking		True Fan Cooking		 (min)
	 (°C)		 (°C)		
Beef	200		190		50 - 70
Pork	180		180		90 - 120
Veal	190		175		90 - 120
English roast beef, rare	210		200		50 - 60
English roast beef, medium	210		200		60 - 70

 MEAT	Conventional Cook- ing	True Fan Cook- ing	 (min)
	 (°C)	 (°C)	
English roast beef, well done	210	200	70 - 75

 MEAT	Conventional Cooking		True Fan Cooking		 (min)
	 (°C)		 (°C)		
Pork shoulder, with rind	180	2	170	2	120 - 150
Pork shin, 2 pieces	180	2	160	2	100 - 120
Leg of lamb	190	2	175	2	110 - 130
Whole chicken	220	2	200	2	70 - 85
Whole turkey	180	2	160	2	210 - 240
Whole duck	175	2	220	2	120 - 150
Whole goose	175	2	160	1	150 - 200
Rabbit, cut in pieces	190	2	175	2	60 - 80
Hare, cut in pieces	190	2	175	2	150 - 200
Whole pheasant	190	2	175	2	90 - 120

Use the second shelf position.





 FISH	Conventional Cooking	True Fan Cooking	 (min)
	 (°C)	 (°C)	
Trout / Sea bream, 3 - 4 fish	190	175	40 - 55
Tuna / Salmon, 4 - 6 fillets	190	175	35 - 60

11.3 Grill

Preheat the empty oven.

Use the fourth shelf position.

Grill with the maximum temperature setting.



 GRILL	 (kg)	 (min) 1st side	 (min) 2nd side
Fillet steaks, 4 pieces	0.8	12 - 15	12 - 14
Beef steak, 4 pieces	0.6	10 - 12	6 - 8
Sausages, 8	-	12 - 15	10 - 12
Pork chops, 4 pieces	0.6	12 - 16	12 - 14
Chicken, half, 2	1	30 - 35	25 - 30
Kebabs, 4	-	10 - 15	10 - 12
Chicken breast, 4 pieces	0.4	12 - 15	12 - 14
Burgers, 6	0.6	20 - 30	-
Fish fillet, 4 pieces	0.4	12 - 14	10 - 12
Toasted sandwiches, 4 - 6	-	5 - 7	-
Toast, 4 - 6	-	2 - 4	2 - 3



11.4 Turbo Grilling



Preheat the empty oven.



Use the first or the second shelf position.



To calculate the roasting time multiply the time given in the table below by the centimetres of thickness of the fillet.



 BEEF	 (°C)	 (min)
Roast beef or fillet, rare	190 - 200	5 - 6
Roast beef or fillet, medium	180 - 190	6 - 8
Roast beef or fillet, well done	170 - 180	8 - 10



 PORK	 (°C)	 (min)
Shoulder / Neck / Ham joint, 1 - 1.5 kg	160 - 180	90 - 120
Chops / Spare rib, 1 - 1.5 kg	170 - 180	60 - 90
Meatloaf, 0.75 - 1 kg	160 - 170	50 - 60

 PORK	 (°C)	 (min)
Pork knuckle, pre-cooked, 0.75 - 1 kg	150 - 170	90 - 120

 VEAL	 (°C)	 (min)
Roast veal, 1 kg	160 - 180	90 - 120
Veal knuckle, 1.5 - 2 kg	160 - 180	120 - 150

 LAMB	 (°C)	 (min)
Lamb leg / Roast lamb, 1 - 1.5 kg	150 - 170	100 - 120
Lamb saddle, 1 - 1.5 kg	160 - 180	40 - 60

 POULTRY	 (°C)	 (min)
Poultry, portions, 0.2 - 0.25 kg each	200 - 220	30 - 50
Chicken, half, 0.4 - 0.5 kg each	190 - 210	35 - 50
Chicken, poulard, 1 - 1.5 kg	190 - 210	50 - 70
Duck, 1.5 - 2 kg	180 - 200	80 - 100
Goose, 3.5 - 5 kg	160 - 180	120 - 180
Turkey, 2.5 - 3.5 kg	160 - 180	120 - 150
Turkey, 4 - 6 kg	140 - 160	150 - 240

 FISH (STEAMED)	 (°C)	 (min)
Whole fish, 1 - 1.5 kg	210 - 220	40 - 60

11.5 Dehydrating - True Fan Cooking

Cover trays with grease proof paper or baking parchment.

For a better result, stop the oven halfway through the drying time, open the door and let it cool down for one night to complete the drying.

For 1 tray use the third shelf position.



Pizza pan

Dark, non-reflective
28 cm diameter

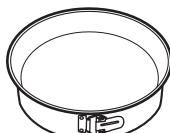

Baking dish

Dark, non-reflective
26 cm diameter



Ramekins

Ceramic
8 cm diameter, 5
cm height





Flan base tin



Dark, non-reflective
28 cm diameter

11.7 Moist Fan Baking

For 2 trays use the first and fourth shelf position.

 VEGETABLES	 (°C)	 (h)
Beans	60 - 70	6 - 8
Peppers	60 - 70	5 - 6
Vegetables for soup	60 - 70	5 - 6
Mushrooms	50 - 60	6 - 8
Herbs	40 - 50	2 - 3





Set the temperature to 60 - 70 °C.

 FRUIT	 (h)
Plums	8 - 10
Apricots	8 - 10
Apple slices	6 - 8
Pears	6 - 9

11.6 Moist Fan Baking - recommended accessories







Use the dark and non-reflective tins and containers. They have better heat absorption than the light colour and reflective dishes.

For the best results follow suggestions listed in the table below.

		 (°C)		 (min)
Sweet rolls, 12 pieces	baking tray or dripping pan	175	3	40 - 50
Rolls, 9 pieces	baking tray or dripping pan	180	2	35 - 45
Pizza, frozen, 0.35 kg	wire shelf	180	2	45 - 55
Swiss roll	baking tray or dripping pan	170	2	30 - 40
Brownie	baking tray or dripping pan	170	2	45 - 50
Soufflé, 6 pieces	ceramic ramekins on wire shelf	190	3	45 - 55
Sponge flan base	flan base tin on wire shelf	180	2	35 - 45
Victoria sandwich	baking dish on wire shelf	170	2	35 - 50
Poached fish, 0.3 kg	baking tray or dripping pan	180	2	35 - 45
Whole fish, 0.2 kg	baking tray or dripping pan	180	3	25 - 35
Fish fillet, 0.3 kg	pizza pan on wire shelf	170	3	30 - 40
Poached meat, 0.25 kg	baking tray or dripping pan	180	3	35 - 45
Shashlik, 0.5 kg	baking tray or dripping pan	180	3	40 - 50
Cookies, 16 pieces	baking tray or dripping pan	150	2	30 - 45
Macaroons, 20 pieces	baking tray or dripping pan	180	2	45 - 55
Muffins, 12 pieces	baking tray or dripping pan	170	2	30 - 40
Savory pastry, 16 pieces	baking tray or dripping pan	170	2	35 - 45
Short crust biscuits, 20 pieces	baking tray or dripping pan	150	2	40 - 50
Tartlets, 8 pieces	baking tray or dripping pan	170	2	30 - 40
Vegetables, poached, 0.4 kg	baking tray or dripping pan	180	2	35 - 45
Vegetarian omelette	pizza pan on wire shelf	180	3	35 - 45
Mediterranean vegetables, 0.7 kg	baking tray or dripping pan	180	4	35 - 45

11.8 Information for test institutes

Tests according to IEC 60350-1.

				 (°C)	 (min)	
Small cakes, 20 per tray	Conventional Cooking	Baking tray	3	170	20 - 30	-
Small cakes, 20 per tray	True Fan Cooking	Baking tray	3	150 - 160	20 - 35	-
Small cakes, 20 per tray	True Fan Cooking	Baking tray	2 and 4	150 - 160	20 - 35	-
Apple pie, 2 tins Ø20 cm	Conventional Cooking	Wire shelf	2	180	70 - 90	-
Apple pie, 2 tins Ø20 cm	True Fan Cooking	Wire shelf	2	160	70 - 90	-
Sponge cake, cake mould Ø26 cm	Conventional Cooking	Wire shelf	2	170	40 - 50	Preheat the oven for 10 minutes.
Sponge cake, cake mould Ø26 cm	True Fan Cooking	Wire shelf	2	160	40 - 50	Preheat the oven for 10 minutes.
Sponge cake, cake mould Ø26 cm	True Fan Cooking	Wire shelf	2 and 4	160	40 - 60	Preheat the oven for 10 minutes.
Short bread	True Fan Cooking	Baking tray	3	140 - 150	20 - 40	-
Short bread	True Fan Cooking	Baking tray	2 and 4	140 - 150	25 - 45	-
Short bread	Conventional Cooking	Baking tray	3	140 - 150	25 - 45	-
Toast, 4 - 6 pieces	Grill	Wire shelf	4	max.	2 - 3 minutes first side; 2 - 3 minutes second side	Preheat the oven for 3 minutes.
Beef burger, 6 pieces, 0.6 kg	Grill	Wire shelf and dripping pan	4	max.	20 - 30	Put the wire shelf on the fourth level and the dripping pan on the third level of the oven. Turn the food halfway through the cooking time. Preheat the oven for 3 minutes.

12. CARE AND CLEANING



WARNING!

Refer to Safety chapters.

12.1 Notes on cleaning



Cleaning Agents

Clean the front of the oven with a soft cloth with warm water and a mild detergent. Clean and check the door gasket around the frame of the cavity.

Use a cleaning solution to clean metal surfaces.

Clean stains with a mild detergent.



Everyday Use

Clean the cavity after each use. Fat accumulation or other residue may cause fire.

Moisture can condense in the oven or on the door glass panels. To decrease the condensation, let the oven work for 10 minutes before cooking. Do not store the food in the oven for longer than 20 minutes. Dry the cavity with a soft cloth after each use.



Accessories

Clean all accessories after each use and let them dry. Use a soft cloth with warm water and a mild detergent. Do not clean the accessories in a dishwasher.

Do not clean the non-stick accessories using abrasive cleaner or sharp-edged objects.

12.2 How to remove: Shelf supports

Remove the shelf supports to clean the oven.

Step 1 Turn off the oven and wait until it is cold.

Step 2 Pull the front of the shelf support away from the side wall.

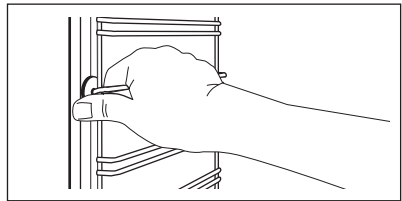

Step 3 Pull the rear end of the shelf support away from the side wall and remove it.

Step 4 Install the shelf supports in the opposite sequence.

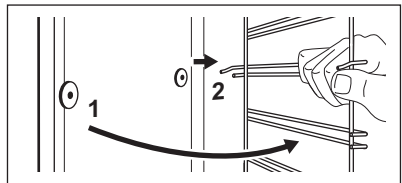

12.3 How to use: Aqua Clean

This cleaning procedure uses humidity to remove remaining fat and food particles from the oven.

Step 1 Pour water into the cavity embossment: 300 ml.

Step 2 Set the function: 

Step 3 Set the temperature to 90 °C.

Step 4 Let the oven work for 30 min.

Step 5 Turn off the oven.

Step 6 Wait until the oven is cold. Dry the cavity with a soft cloth.

12.4 How to remove and install: Door

The oven door has two glass panels. You can remove the oven door and the internal glass panel to clean it. Read the whole "Removing and installing door" instruction before you remove the glass panels.



CAUTION!

Do not use the oven without the glass panels.

Step 1 Open the door fully and hold both hinges.

Step 2 Lift and turn the levers fully on both hinges.

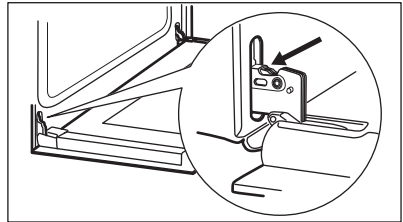

Step 3 Close the oven door halfway to the first opening position. Then lift and pull forward and remove the door from its seat.

Step 4 Put the door on a soft cloth on a stable surface.

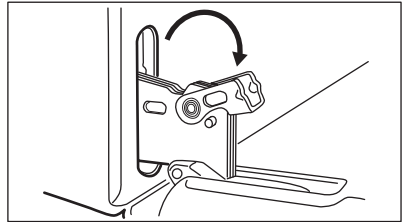

Step 5 Hold the door trim (B) on the top edge of the door at the two sides and push inwards to release the clip seal.

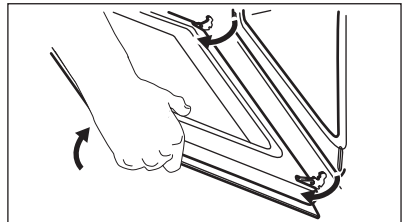

Step 6 Pull the door trim to the front to remove it.

Step 7 Hold the door glass panel by its top edge and carefully pull it out. Make sure the glass slides out of the supports completely.

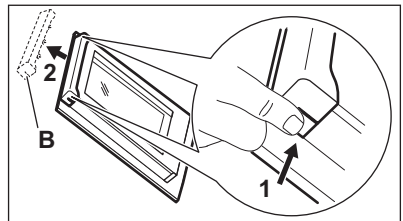

Step 8 Clean the glass panels with water and soap. Dry the glass panels carefully. Do not clean the glass panels in the dishwasher.

Step 9 After cleaning, install the glass panel and the oven door.

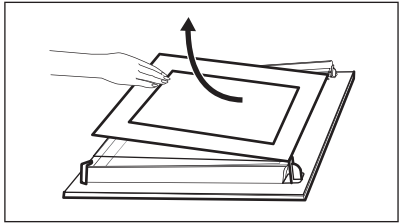

The screen-printing zone must face the inner side of the door. Make sure that after the installation the surface of the glass panel frame on the screen-printing zones is not rough when you touch it. When installed correctly the door trim clicks. Make sure that you install the internal glass panel in the seats correctly.

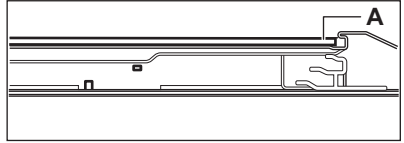

12.5 How to replace: Lamp



WARNING!
Risk of electric shock.
The lamp can be hot.

Always hold the halogen lamp with a cloth to prevent grease residue from burning on the lamp.

Before you replace the lamp:

Step 1	Step 2	Step 3
Turn off the oven. Wait until the oven is cold.	Disconnect the oven from the mains.	Put a cloth on the bottom of the cavity.

Back lamp

- Step 1** Turn the glass cover to remove it.
- Step 2** Clean the glass cover.
- Step 3** Replace the lamp with a suitable 300 °C heat-resistant lamp.
- Step 4** Install the glass cover.

13. TROUBLESHOOTING



WARNING!
Refer to Safety chapters.

13.1 What to do if...

In any cases not included in this table please contact with an Authorised Service Centre.

Problem	Check if...
The oven does not heat up.	The fuse is blown.
The door gasket is damaged.	Do not use the oven. Contact an Authorised Service Centre.

Problem	Check if...
The display shows "12.00".	There was a power cut. Set the time of day.
The lamp does not work.	The lamp is burnt out.

If you cannot find a solution to the problem yourself, contact your dealer or an Authorised Service Centre.

The necessary data for the service centre is on the rating plate. The rating plate is on the front frame of the oven cavity. Do not remove the rating plate from the oven cavity.

13.2 Service data

We recommend that you write the data here:

Model (MOD.)
Product number (PNC)
Serial number (S.N.)

14. ENERGY EFFICIENCY

14.1 Product Information and Product Information Sheet*

Supplier's name	Electrolux	
Model identification	KOFGH40TW 949496295 KOFGH40TX 949496296	
Energy Efficiency Index	95.3	
Energy efficiency class	A	
Energy consumption with a standard load, conventional mode	0.93 kWh/cycle	
Energy consumption with a standard load, fan-forced mode	0.81 kWh/cycle	
Number of cavities	1	
Heat source	Electricity	
Volume	72 l	
Type of oven	Built-In Oven	
Mass	KOFGH40TW	27.4 kg
	KOFGH40TX	27.4 kg

* For European Union according to EU Regulations 65/2014 and 66/2014.
For Republic of Belarus according to STB 2478-2017, Appendix G; STB 2477-2017, Annexes A and B.
For Ukraine according to 568/32020.

Energy efficiency class is not applicable for Russia.

EN 60350-1 - Household electric cooking appliances - Part 1: Ranges, ovens, steam ovens and grills - Methods for measuring performance.

14.2 Energy saving



The oven has features which help you save energy during everyday cooking.

Make sure that the oven door is closed when the oven operates. Do not open the oven door too often during cooking. Keep the door gasket clean and make sure it is well fixed in its position.

Use metal cookware to improve energy saving.

When possible, do not preheat the oven before cooking.

Keep breaks between baking as short as possible when you prepare a few dishes at one time.

Cooking with fan

When possible, use the cooking functions with fan to save energy.

Residual heat

When the cooking duration is longer than 30 min, reduce the oven temperature to

minimum 3 - 10 min before the end of cooking. The residual heat inside the oven will continue to cook.

Use the residual heat to warm up other dishes.

Keep food warm

Choose the lowest possible temperature setting to use residual heat and keep a meal warm.

Moist Fan Baking

Function designed to save energy during cooking.

15. ENVIRONMENTAL CONCERNS

Recycle materials with the symbol . Put the packaging in relevant containers to recycle it. Help protect the environment and human health by recycling waste of electrical and electronic appliances. Do not dispose of

appliances marked with the symbol  with the household waste. Return the product to your local recycling facility or contact your municipal office.

CE

867359388-A-182020