



# **USER MANUAL**

## **VPR BATTERY HEATING SYSTEM**

EXPION360

## **VPR HEATING SYSTEM MODEL EX-G24-TJ-KIT**

## **VPR HEATING SYSTEM MODEL EX-G27-TJ-KIT**

### **DESCRIPTION**

The VPR Battery Heating System is designed to heat the VPR 4Ever Series deep cycle lithium (LiFePO<sub>4</sub> / LFP) batteries to primarily allow charging below 32°F. Model EX-G24-HP is designed for the VPR 4Ever Series group 24 size 60, 80, and 95Ah LFP batteries. Model EX-G27-HP is designed for the group 27 size 100 and 120Ah LFP batteries. There are no heating options for the VPR 4Ever Platinum 360Ah battery. Even though the heating element is thermostat controlled There is a master switch included to turn on and off the heating element to have complete control of the system. To assist the heating element by trapping and directing the heat inward toward the battery there is an R12 rated Thermal Jacket included that uses Insultex Insulation commonly used in arctic clothing.

### **HARDWARE INCLUDED**

- 1 - HEATING ELEMENT.
- 1 - THERMAL JACKET
- 1 - 20ADC MASTER SWITCH
- 1 - MINI BLADE FUSE HOLDER.
- 1 - 10A MINI BLADE FUSE.
- 3 - 5/16" RING TERMINALS.
- 2 - 3/8" RING TERMINALS.
- 3 - 16ga TERMINAL CONNECTORS.

### **INSTALLATION**

- 1.** Remove the adhesive backing from the heating element. Stick the adhesive side of the element to the battery lining it up along the bottom edge of the battery. Continue to install the element lengthwise around the battery pressing firmly to adhere it to the plastic. You will end up with a small gap where the two ends join.
- 2.** Install the included fuse holder to the positive battery terminal using one of the included 5/16" ring terminals. Install the other end into the Pos Pin 2 position on the switch using the 16Ga terminal connector. Install the included 10A mini fuse into the fuse holder and close the cover. This wire will need to be extended to install the master switch in a more desirable location.
- 3.** Install the white negative wire from the heating element using one of the included 5/16" ring terminals directly to the negative black terminal on the battery or use the 3/8" ring terminal if installing a battery monitor with a shunt.
- 4.** Install the red positive wire from the heating element to the Pos Pin 3 position on the switch using the 16Ga terminal connector. This wire will need to be extended to install the switch in a more desirable location.
- 5.** Install the short white wire to the Neg Pin 1 position on the switch using the 16Ga terminal connector and the other end to the battery negative black terminal using the 5/16" or 3/8" ring terminals. This wire will need to be extended to move the switch to a more desirable location. One switch is rated to be used for up to two heating elements.
- 6.** If the batteries are installed in an outside unheated battery box add as much additional insulation as possible to help make the heating system more effective. Preferably use at least 2" nonconductive and nonflammable foam.
- 7.** If installing the batteries inside the RV with furnace heating make sure the battery location has vents to allow warm air from the furnace to flow around the batteries to help make the battery heating system highly effective. No additional insulation is needed for an inside installation.

# USE INSTRUCTIONS

Turn on the heating system when temperatures are at 35-40°F to allow the battery(s) to preheat before charging at or below 32°F. If the battery(s) have been at or below 32°F for longer than one hour they will require a longer preheat period before charging. Make sure there is enough Amp-hour capacity in the battery(s) to allow the preheat period without running out of energy. The heating element will draw up to 5A per heating element while the thermostat is in the closed state (ON). When the battery has reached its full temperature potential the thermostat will cycle on and off to maintain that temperature drawing much less power from the battery than it did during the preheat period.

## BATTERY MONITORING

it is recommended to use a battery monitor such as the Expion360 model when drawing power from the battery(s) for the battery heating system. This will allow the user to determine if there is enough capacity (Ah) in the battery to allow a preheat period before charging.

## ACCESSORIES

The products listed below are just a few items Expion360 manufactures that are available for use with the heating elements. For questions regarding these products, please email [support@expion360.com](mailto:support@expion360.com).

**Model EV-BM350:** Battery monitor with display, 500A shunt, 35' cable, and mounting bracket.

## MODEL EX-G24-HP / EX-G27-HP TECHNICAL SPECIFICATIONS

### ELECTRICAL PARAMETERS

VOLTAGE	12VDC
CURRENT EX-G24-HP	5A
CURRENT EX-G27-HP	6A
ENERGY EX-G24-HP	78W
ENERGY EX-27-HP	85W
FUSE SIZE	10A
FUSE TYPE	MINI BLADE
UL LISTING	UL499

### MECHANICAL PARAMETERS

DIMENSIONS (L X W) INCHES EX-G24-HP	6.70 X 32.00
DIMENSIONS (L X W) INCHES EX-G27-HP	6.70 X 35.40
WEIGHT EX-G24-HP	.80Lbs
WEIGHT EX-G27-HP	.85Lbs
THERMAL JACKET RATING	R12
THERMAL JACKET INSULATION	INSULTEX

### TEMPERATURE PARAMETERS





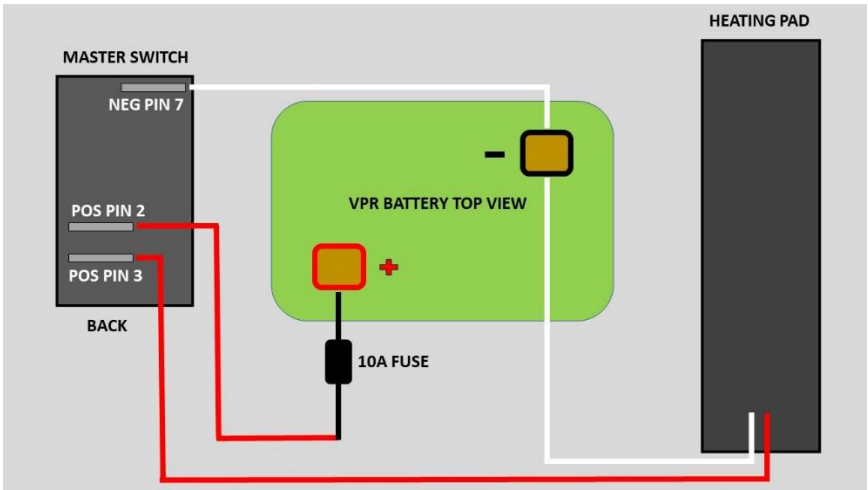



THERMOSTAT ON	45±5°F
THERMOSTAT OFF	68±5°F

## WIRING DIAGRAM



# NOTICE

## TO PREVENT DAMAGE AND EXTEND HEATING SYSTEM LIFE PLEASE FOLLOW THESE PRECAUTIONS

-  DO NOT SHORT CIRCUIT THE HEATING SYSTEM
-  DO NOT SUBMERGE THE HEATING SYSTEM IN WATER
-  DO NOT CONNECT MORE THAN FOUR HEATING ELEMENTS IN PARALLEL
-  DO NOT CUT THE HEATING ELEMENT AS IT IS PRESIZED FOR THE BATTERY
-  DO NOT ATTEMPT REPAIR OF THE HEATING ELEMENT IF MALFUNCTIONING
-  DO NOT CHARGE THE BATTERY BELOW  $-4^{\circ}\text{F}$  WHEN THE HEATING SYSTEM IS ON
-  DO NOT DISCHARGE THE BATTERY BELOW  $-4^{\circ}\text{F}$  WHEN THE HEATING SYSTEM ON
-  DO NOT RUN HEATING SYSTEM INDEFINITELY. SHUT OFF WITH THE MASTER SWITCH

**EXPION360**

**(541) 797-6714**

**support@expion360.com**

**expion360.com**