

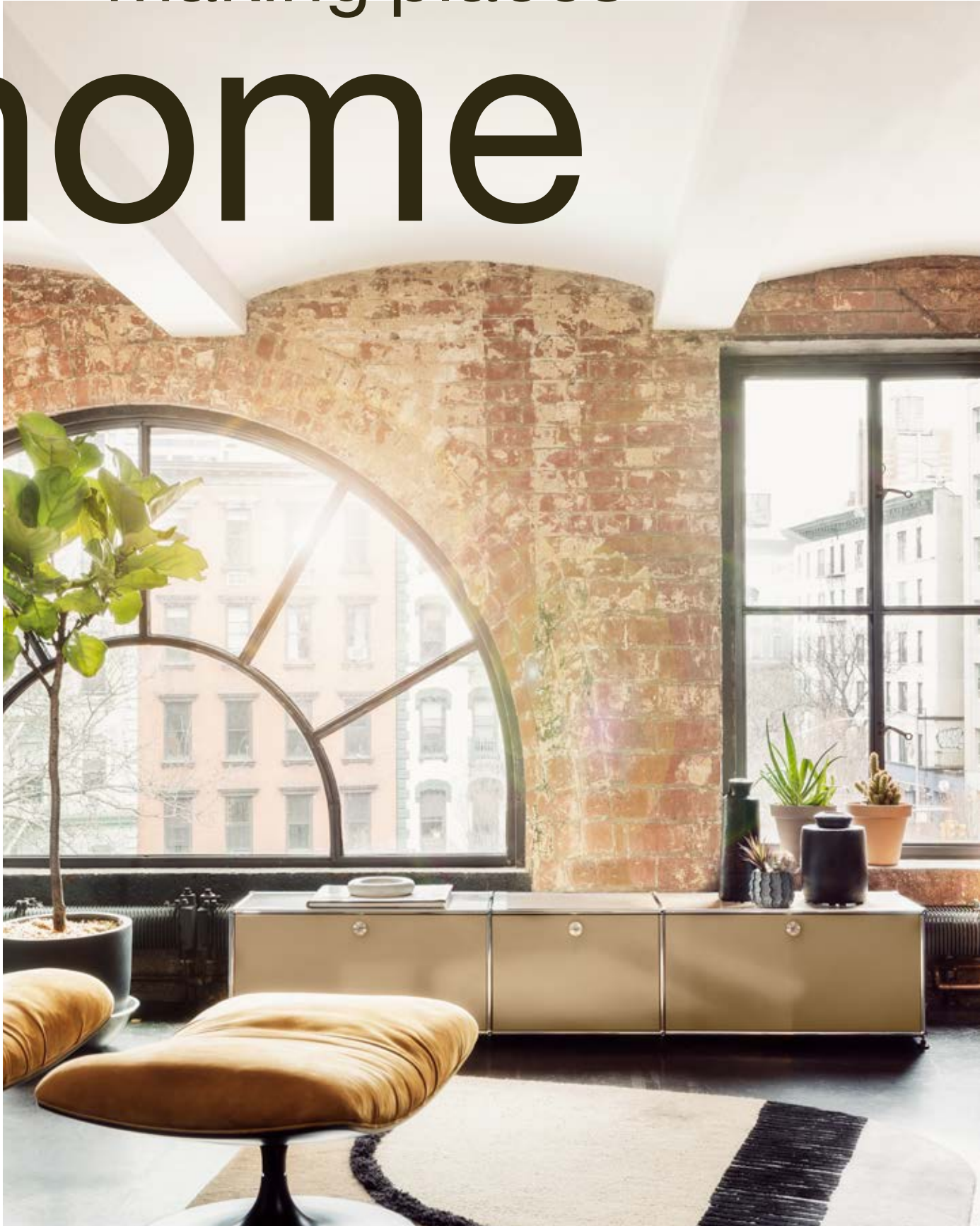

making places

home

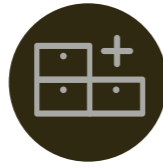



Online Configurator
Design your individual
piece of USM online!



Customized Service
Visit a USM Showroom or
one of our 400 international
sales partners worldwide for
individual support. Find your
closest USM professional
online.

www.usm.com

- 2 Living room
- 12 Dining
- 18 Entertainment
- 28 Bedroom
- 34 Kids
- 38 Shelving
- 46 Storage
- 56 Home office

The USM world

- 66 Strong core values
- 68 Product information
- 78 Colours & surfaces

Making places home Home is our personal retreat, the private space where we share special time with family and friends.

It is a reflection of our lifestyle, our attitudes and the things that mean the most to us. As our lives and tastes change, our home evolves with us – always in synch with our current needs.

USM Modular Furniture is designed to accompany us through different phases of life. It adjusts to new demands, ready to take up different functions in our home – a constant in our ever-shifting lives. On the following pages we present the diverse world of USM: from minimal to eclectic, from functional to decorative. Always modular and adjustable. Furniture for a lifetime made with great care in Switzerland.

Living room

It is simply about living your ideas, your style.

Make your home personal. Clear lines, versatile modularity: USM Haller lets you decide. Unobtrusive but essential, it adapts to your lifestyle, your changing needs, your personal taste. An enduring companion.

1 Sideboard
W/D/H: 2273/523/430 mm
with one extension door,
counterweight and castors
£1'864.69



Living room



- ↙ 2 Sideboard
W/D/H: 2273/373/740 mm
with three drop-down doors
£2'013.23
- 3 USM Haller E
TV/HiFi unit*
W/D/H: 1523/373/390 mm
with one drop-down door
and one cable cut-out
£1'670.42
*with a dimmable cold or
warm white light



4 Sideboard
W/D/H: 1523/373/740 mm
with four drop-down doors
£1'882.73



5 Sideboard
W/D/H: 2273/373/740 mm
with two drop-down doors
and one extension door
with box insert
£2'242.58

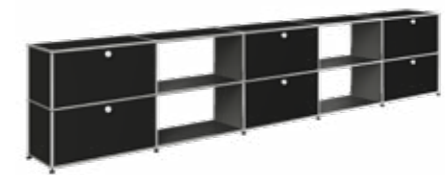

6 Sideboard
W/D/H: 3773/373/740 mm
with three drop-down doors
and three extension doors
£4'062.90

Living room



7 USM Haller E
Glass showcase*
W/D/H: 773/523/1090 mm
with three glass doors
£5'102.03
*with a dimmable cold or
warm white light

8 Glass showcase
W/D/H: 3023/373/740 mm
with eight glass doors
£5'222.95



9 Glass showcase
W/D/H: 1523/373/740 mm
with four glass doors
£2'780.02



10 USM Haller occasional
table, square
L/D/H: 750/750/370 mm
Brown oiled oak veneer
£849.49



11 Sideboard
W/D/H: 1023/1023/540 mm
£971.30



12 Side table
W/D/H: 523/373/390 mm
with one fixed shelf
£427.92

Living room

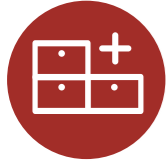

Create the colour combination of your dreams with our configurator.
www.usm.com

↙
13 Storage unit
W/D/H: 2273/373/915 mm
with six drop-down doors
and three extension doors
£5'368.99

↘
14 Storage unit
W/D/H: 2273/373/2490 mm
with fifteen drop-down doors
and six flip-up doors
£9'716.75

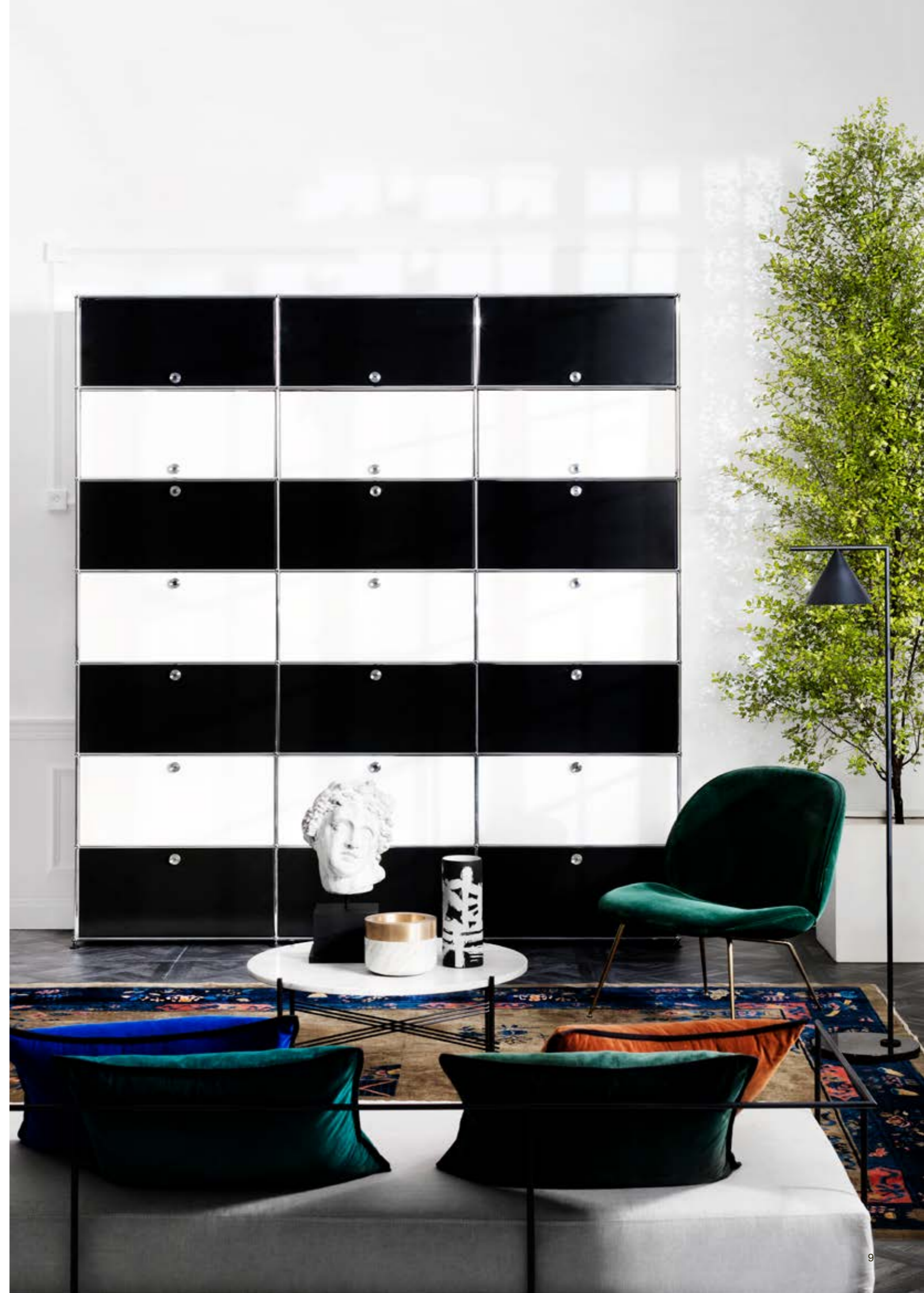

Living room

↓
15 Side table
W/D/H: 723/723/390 mm
£1'354.03

↘
16 Shelving
W/D/H: 3673/373/2490 mm
with nine drop-down doors
£8'781.20

↘
17 Side table
W/D/H: 523/523/435 mm
£302.83



Dining

Sharing time together with family and friends is priceless.

It is often little things that make life richer. Spending time with loved ones, eating, talking, laughing together. All it takes is a large table to gather around. Pure and simple in design, the USM Haller Table allows you to dine in style.

18 USM Haller table
Rectangular
L/D/H: 2000/1000/740 mm
transparent glass
£4'596.68

19 USM Haller E
Glass showcase*
W/D/H: 2523/373/1865 mm
with four extensions doors
and eight glass doors
£11'838.11
* with a dimmable cold or
warm white light



Dining



20 Shelving
W/D/H: 2273/373/1090 mm
with six drop-down doors
£3'497.21

21 USM Haller table
Rectangular
L/D/H: 1750/1000/740 mm
transparent glass
£4'226.22

22 Shelving
W/D/H: 3773/523/665 mm
with five drop-down doors
and five extension doors
with box inserts
£6'449.11



23 Shelving
W/D/H: 1523/373/1090 mm
with four drop-down doors
£2'375.14



24 Shelving
W/D/H: 2273/373/1315 mm
with seven drop-down doors
and two extension doors
with box insert
£5'348.17



25 Coffee trolley
W/D/H: 1023/523/1126 mm
with pull handle, one extension
door with box insert, two drop
down doors, one divider shelf,
two Inos boxes and casters
£3'216.17

Dining



↙
 26 Plant trolley
 W/D/H: 773/523/675 mm
 with plant pots, a pull handle
 and castors
 £1'041.95

↘
 27 Shelving
 W/D/H: 2523/373/1560 mm
 with twelve drop-down doors
 and two glass doors
 £6'317.10



28 Sideboard
 W/D/H: 1523/373/740 mm
 with two drop-down doors
 £1'362.42



29 Sideboard
 W/D/H: 2273/373/640 mm
 with three drop-down doors
 £2'006.32



30 USM Haller table
 Rectangular
 L/D/H: 1750/750/740 mm
 Pastel gray laminate
 £1'013.62



31 Serving trolley
 W/D/H: 773/523/575 mm
 with a pull handle and casters
 £568.50

Trends come and go while classic design is constant.

Clean in shape, honest in materialisation, timeless in design – USM Haller exists beyond trends. The beat of your life might change from time to time, another must-have home gadget might arrive. USM stays and adapts.

32 USM Haller E Shelving*
W/D/H: 3373/373/1440 mm
with plant pots, four extension doors and one drop-down door
£6'654.04
*with a dimmable cold or warm white light



Entertainment



↙
33 Sideboard
 W/D/H: 2273/373/740 mm
 with three extension doors
 £2'665.85

↙
34 Sideboard
 W/D/H: 1523/373/540 mm
 with two glass panels on top
 and two extension doors
 £2'640.55



35 Sideboard
 W/D/H: 1523/373/565 mm
 with four drop-down doors
 £1'852.67

36 Sideboard
 W/D/H: 1523/373/740 mm
 with two drop-down doors
 £1'530.62

37 Low mobile TV/HiFi unit
 W/D/H: 1523/373/430 mm
 with two divider shelves,
 cable cut-out and casters
 £948.62

38 Low mobile TV/HiFi unit
 W/D/H: 1523/373/430 mm
 with two drawers,
 counterweight and casters
 £2'372.57

39 Sideboard
W/D/H: 2023/523/740 mm
with one drop-down door,
one extension shelf,
three extension doors
and cable cut-out
£3'164.30



Entertainment



40 Sideboard
W/D/H: 1523/373/740 mm
with two drop-down doors
£1'362.42

41 Low mobile
TV/HiFi unit
W/D/H: 3023/523/430 mm
with four drop-down doors
and casters
£2'281.27



42 Sideboard
W/D/H: 1523/373/565 mm
with two drop-down doors
£1'335.85



43 Low mobile
TV/HiFi unit
W/D/H: 1523/373/430 mm
with two drop-down doors
and casters
£1'125.18

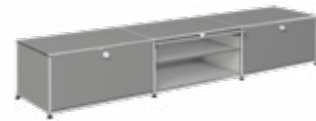

44 Low TV/HiFi unit
W/D/H: 2273/523/390 mm
with two drop-down doors,
one flip-up door
and one divider shelf
£1'849.99



45 Side table
W/D/H: 773/373/565 mm
with one drop-down door
£742.28

46 Sideboard
W/D/H: 4523/373/740 mm
with six drop-down doors,
two extension shelves
and four extension doors
with box inserts
£6'293.76



47 Storage unit
W/D/H: 1873/373/390 mm
with three drop-down doors
£1'463.74



Would you like this piece of furniture to be wider, higher or lower? Configure your own furniture online.
www.usm.com

Enjoy the peace and relax.

A bedroom is a place to relax, to recharge – your sanctuary. With its sheer simplicity, USM design helps you to ease your mind – offering enough variations to create your own personal sense of calm.



Bedroom



48 Storage unit
W/D/H: 773/525/1265 mm
with one extension door,
two drop-down doors and
two A6 drawers
£2'378.60

49 Storage unit
W/D/H: 2273/373/890 mm
with nine extension doors
£5'284.25



50 Storage unit
W/D/H: 2273/523/565 mm
with three extension doors
and six A6 drawers
£3'756.18



51 Storage unit
W/D/H: 1523/523/915 mm
with four A6 drawers
and six extension doors
£5'082.40



52 Storage unit
W/D/H: 773/373/915 mm
with two drop-down doors,
two divider shelves,
one extension door with
box insert
£1'828.37

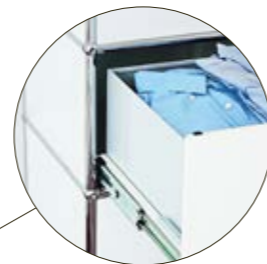

Spacious drawers
Discover the full
range of smart
inner organizational
elements — p. 69.

Bedroom



↙
53 Side table
W/D/H: 523/373/565 mm
with one drop-down door
£681.52

→
54 USM Haller E
Side table*
W/D/H: 523/373/565 mm
with one drop-down door
£1'309.38
*with a dimmable cold or
warm white light

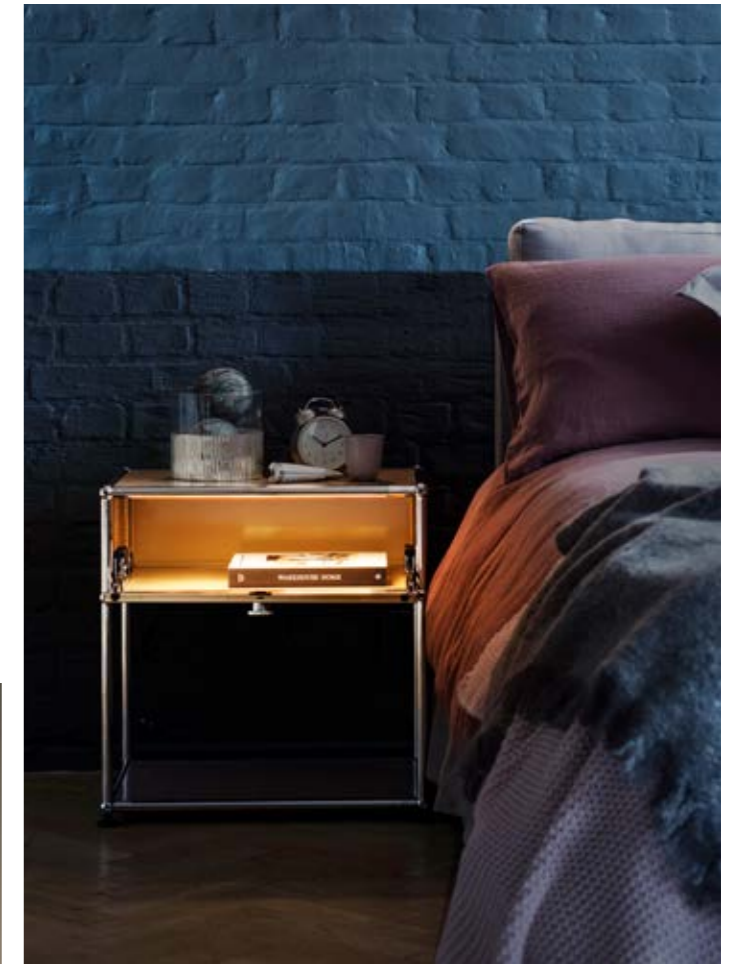

USB chargers ensure that all mobile devices are powered 24 hours a day and transform the design classic into a charging station.



55 Side table
W/D/H: 773/373/840 mm
with two drop-down doors
£1'150.30



56 Storage unit
W/D/H: 1023/373/565 mm
with two drop-down doors
£1'365.40



57 Side table
W/D/H: 773/373/740 mm
with one drop-down door
£858.28



58 Side table
W/D/H: 523/373/565 mm
with one drop-down door
£739.72

A playful start to grow into a great future.

Why not add a bit of color to your design? USM Haller marks a playful spot in your children's room. It serves as a toy box, a bookshelf or storage. A lifelong companion, growing with your children as their needs change.



- ↙ 59 Shelving
W/D/H: 3273/373/2140 mm
with ten drop-down doors
£5'767.15
- 60 Toy box
W/D/H: 373/373/390 mm
£355.04
- ↘ 61 Toy box
W/D/H: 523/523/430 mm
with casters
£445.34



-  62 Desk with toy box
W/D/H: 1273/523/580 mm
with casters
£827.77
-  63 Storage unit
W/D/H: 1523/373/1090 mm
with four drop-down doors
£2'416.19
-  64 Low storage unit
W/D/H: 2023/373/390 mm
with four drop-down doors
£1'871.34

65 Low mobile storage unit
W/D/H: 3023/523/490 mm
with four drop-down doors
and double castors
£2'909.11



LET
R



Shelving

Beauty and function from all sides.

USM Haller gives you the choice – and endless design possibilities. Deliberately showcase your treasured pieces: as room-dividing eye-catchers freestanding in the open space – or discreetly fitted into any niche.

66 Shelving
W/D/H: 2973/373/1965 mm
with four drop-down doors,
two flip-up doors,
four extension doors with
one box insert low and
cable cut-out
£8'418.13



Shelving

↙
67 Shelving
W/D/H: 2273/373/1940 mm
with six drop-down doors
£4'710.61

→
68 Shelving
W/D/H: 1418/373/2915 mm
with four drop-down doors
£4'960.78



Shelving



69 Shelving
W/D/H: 2273/373/1440 mm
with three drop-down doors
and three extension doors
£4'072.93

70 Shelving
W/D/H: 3523/373/2190 mm
with six drop-down doors
and five extension doors
£8'535.91



With our configurator you
can playfully create your own
individual furniture.
www.usm.com



71 Shelving
W/D/H: 3023/373/2140 mm
with one drop-down door
£3'565.80



72 Shelving
W/D/H: 3523/373/1790 mm
with ten drop-down doors
£6'439.37



73 Shelving
W/D/H: 3773/373/2140 mm
£5'113.37

Shelving



↙ 74 USM Haller E
Glass showcase*
W/D/H: 3773/373/915 mm
with ten glass doors
£10'613.81
*with a dimmable cold or
warm white light

↓ 75 USM Haller E
Shelving*
This piece has special
dimensions, our sales partners
will be happy to advise you.
*with a dimmable cold or
warm white light

↓ 76 Side table
W/D/H: 523/418/475 mm
with casters
£336.60

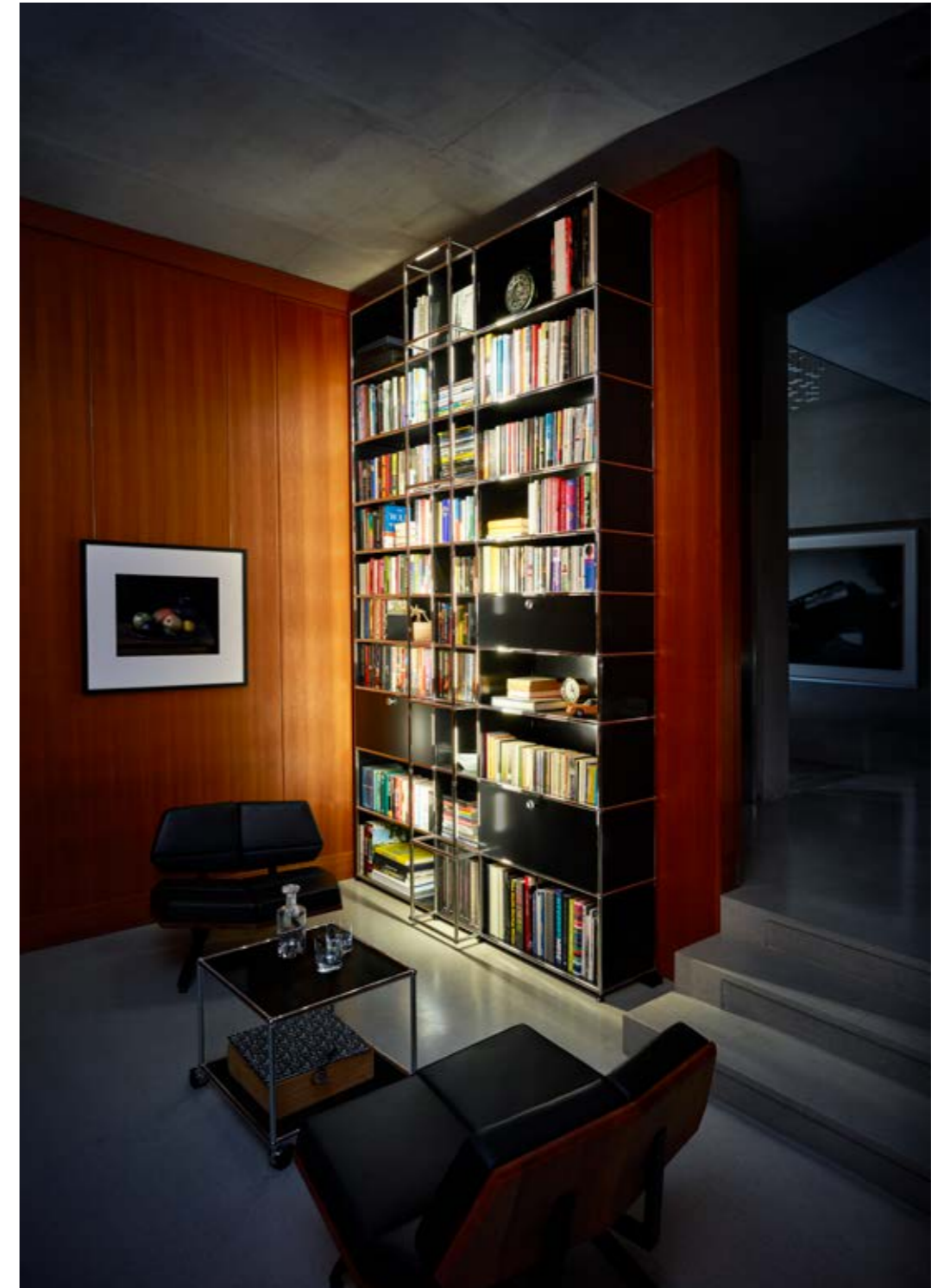

Storage

Our versatility with an unassuming face.

Thanks to its modularity and timelessness, USM fits into every environment, fulfilling a wide range of functions within your home. It adapts to your needs and taste. And it helps you organise your home, offering all the space you need – wherever you want it.



↙
77 Mobile pedestal
W/D/H: 773/523/755 mm
with one drop-down door,
two extension doors,
one box insert above, castors
and counterweight
£2'254.19

→
78 Shelving
W/D/H: 523/373/1590 mm
with three extension doors
and box insert
£2'359.98



79 Sideboard
W/D/H: 1523/373/890 mm
with two extension doors
and counterweight
£2'604.68



80 Shelving
W/D/H: 773/373/1090 mm
with three drop-down doors
£1'483.91



81 Mobile pedestal
W/D/H: 523/373/605 mm
with three extension doors,
box insert, castors and
counterweight
£2'305.49



Organizing trays
Discover the full
range of smart
accessories —
p. 69.

Storage



82 Glass showcase
W/D/H: 1023/373/1740 mm
with four drop-down doors
and six glass doors
£5'059.27

83 Sideboard
W/D/H: 2273/723/890 mm
with six drop-down doors
without cover*
£4'470.26

* Cover is not available
in the USM standard range.



84 USM Haller E
Glass showcase*
W/D/H: 1523/373/1440 mm
with eight glass doors
£7'158.14

*with a dimmable cold or
warm white light



85 Sideboard
W/D/H: 1523/723/915 mm
with six drop-down doors
and six extension doors
£5'859.82



86 Glass showcase
W/D/H: 1023/373/1340 mm
with two drop-down doors
and two glass doors
£2'768.86



87 Glass showcase
W/D/H: 773/373/1440 mm
with four glass doors
£2'896.19

Storage



↙
88 Wardrobe
 W/D/H: 2273/723/1790 mm
 with two drop-down doors,
 two extension doors and
 box insert, two flip-up doors,
 and a coat rack
 £7'400.83

→
**89 USM Haller E
 Wardrobe***
 W/D/H: 1623/373/1440 mm
 with two drop-down doors,
 a clothes rail and plant panels
 with plant pots
 £5'177.63
 *with a dimmable cold or
 warm white light



90 Wardrobe
 W/D/H: 1523/523/1265 mm
 with seven extension doors
 with box insert and a coat rack
 £5'966.81



91 Wardrobe
 W/D/H: 773/373/1915 mm
 with two extension doors with
 box insert and a coat rack
 £2'165.63



92 Wardrobe
 W/D/H: 2723/1473/1790 mm
 with one drop-down door,
 four extension shelves and
 one extension door with box
 insert and two divider shelves
 and three coat racks
 £8'686.34

Storage

93 Shelving
This piece has special dimensions, our sales partners will be happy to advise you.



Storage



↙
94 Shelving
W/D/H: 1023/373/815 mm
with two drop-down doors
£1'534.60

↓
95 Wardrobe
W/D/H: 1523/373/1440 mm
with three drop-down doors
£2'195.82



↘
96 USM Inos C4 box set
Available in seven colours
£155.29



Design your individual
piece of USM online!
www.usm.com

Home office

Feel at home while you work at home.

The home office is a natural part of modern working life. An inspiring environment is not only stylish but enhances well-being and productivity. USM adds quality to the workplace in your home – and to your life at large.

97 Desk
W/D/H: 2623/523/1090 mm
with three drop-down doors
and one extension shelf
£2'772.04



Home office



↙
 98 Shelving
 W/D/H: 773/373/1790 mm
 with two drop-down doors,
 one divider shelf and one
 extension door with box insert
 £2'366.33

→
 99 Shelving
 W/D/H: 773/373/1090 mm
 with two drop-down doors,
 one extension door with box insert
 and cable cut-out on the backwall
 £2'080.97



100 Shelving
 W/D/H: 1523/373/1090 mm
 with four extension doors
 and filing frames
 £3'423.55



101 Mobile pedestal
 W/D/H: 1023/373/605 mm
 with four drop-down doors
 and casters
 £1'761.59



102 Shelving
 W/D/H: 3523/373/1790 mm
 with thirteen drop-down doors
 £7'373.87

103 USM Haller desk
 Rectangular
 L/D/H: 1500/750/740 mm
 Pearl gray laminate
 £867.48

104 USM Haller E Shelving*
W/D/H: 3773/373/2090 mm
with plant pots, four
drop-down doors and
two extension doors
£9'547.66
* with a dimmable cold or
warm white light

105 USM Haller desk
Rectangular
L/D/H: 2000/750/740 mm
Black linoleum
£1'477.73



Watch
the progress!



↙
106 Sideboard
 W/D/H: 1523/373/740 mm
 with four drop-down doors and
 two USM Inos C4 box sets
 £2'250.18

→
**107 USM Haller E
 Desk***
 W/D/H: 2023/548/1090 mm
 with two drop-down doors,
 two extension doors
 and two extension shelves
 £7'349.30
 *with a dimmable light and a cold or
 warm white light on opening the
 compartment plus a USB charger



The golden yellow work and charging station boosts the energy in your home office. The barely visible lights and USB chargers embedded in the tubes can be disconnected and moved at any time.



Light when compartment is opened – sensor-controlled lights in drawers and compartments turn on automatically when opened.



108 Shelving
 W/D/H: 773/373/1790 mm
 with two drop-down doors
 £1'860.72



109 Sideboard
 W/D/H: 1523/373/740 mm
 with two drop-down doors
 and two extension doors
 with filing frames
 £2'489.76



110 Shelving
 W/D/H: 773/373/1440 mm
 with two drop-down doors
 £1'504.06



111 Desk
 W/D/H: 1273/523/740 mm
 with two drop-down doors
 £1'391.17

- 112 Shelving
W/D/H: 2023/373/1440-2390 mm
with 3 drop-down doors, two
glass doors and six plant pots
£4'813.92
- 113 USM Kitos M desk
L/D/H: 1750/750/700-1200 mm
Linoleum Pebble
£2'573.41
- 114 Mobile pedestal
W/D/H: 418/523/605 mm
with three A6 drawers,
with counterweight and castors
£1'358.87



Strong core

values

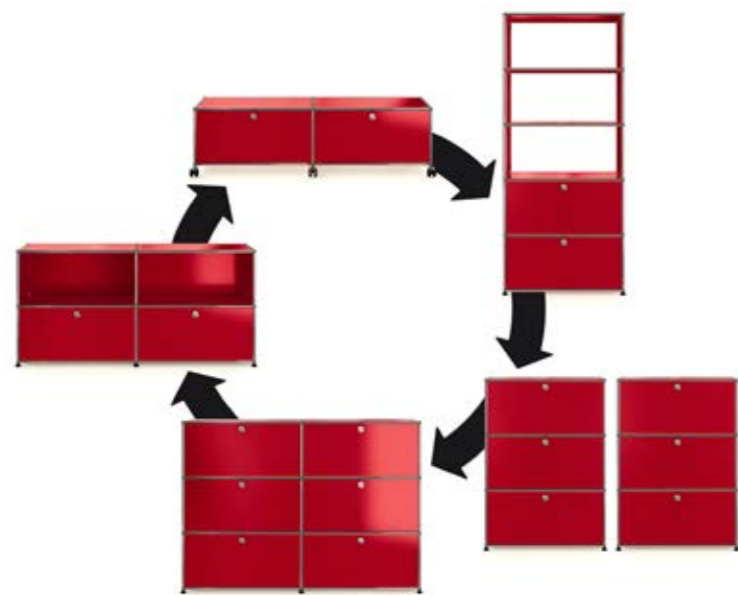

Form follows you

Unlike many static design classics, celebrating individuality by adapting design and function to its user. For more than 55 years, flexibility, durability and consequently sustainability are core values of the USM brand. USM Modular Furniture is designed to be reconfigured – at any time.



Sustainable concepts and actions

Developing solutions that respond to changing needs while remaining environmentally conscious has always been a USM philosophy. Since the beginning, and throughout USM's development, handling energy, emissions, materials and production methods in a responsible manner has been a key mission. In this regard, the longevity of USM products is of utmost importance. The longer the product can be used, the less impact it has on the environment. High-quality, durable materials, manufactured with the latest environmentally friendly technologies, guarantees a long, useful life for our product.

Made in Switzerland

Founded in 1885, USM is a family business now in its fourth generation. «Made in Switzerland» to us is both a promise and an obligation. It stands for precision, quality, dependability, first-rate materials, careful workmanship and total commitment – on behalf of customer interest and out of respect for the environment.



Founded in 1885 and headquartered in Münsingen, Switzerland, USM today is still a family-owned and family-led business, now in its fourth generation.

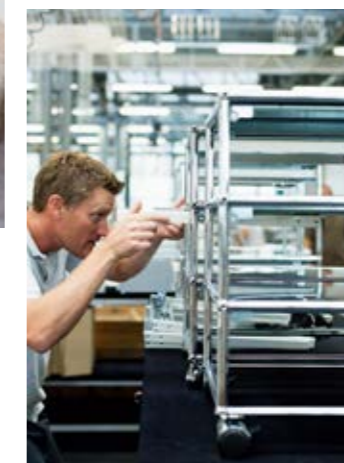

Worldwide services

USM provides trained specialists in furniture configuration, delivery and installation to ensure professional customer support. For USM assembly and repair, contact us directly or one of our 400 authorised sales partners in 40 countries, guaranteeing top-quality service around the world. Our modular system embodies dependability, and our customer service guarantees that you will receive quick, personalised answers to your questions. For customized advice, do not hesitate to visit our showrooms. USM has established a prominent reputation and international presence with flagship stores in Bern, Hamburg, London, Munich, New York, Paris and Tokyo that showcase local culture and offer technical support.

USM Haller

The USM Haller system provides a wide variety of elements in standard sizes. Widths, depths and heights are indicated below. All measurements refer to the distance between axes.



Your safety matters to us. Check out the USM safety instructions now. www.usm.com/safety

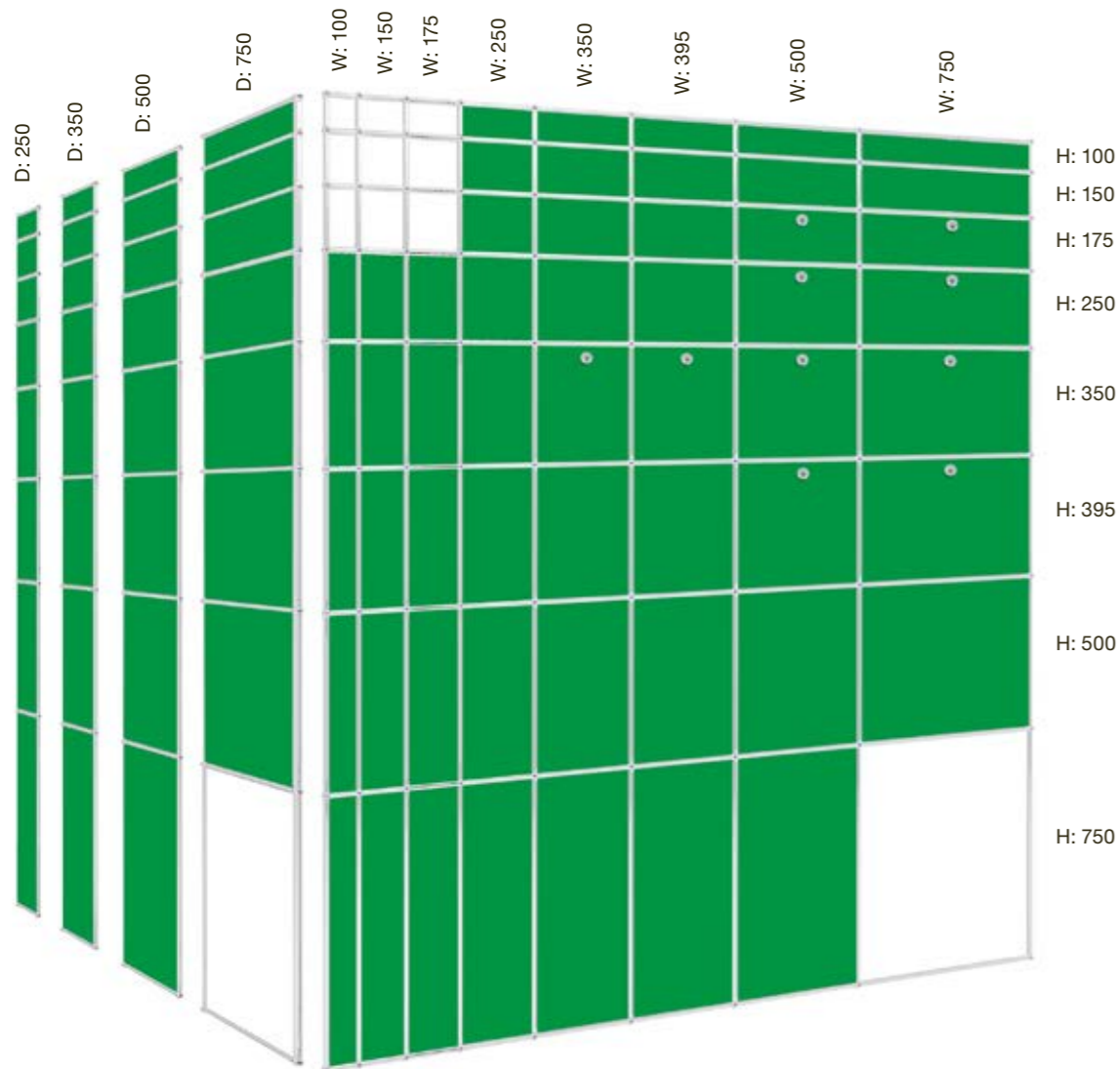
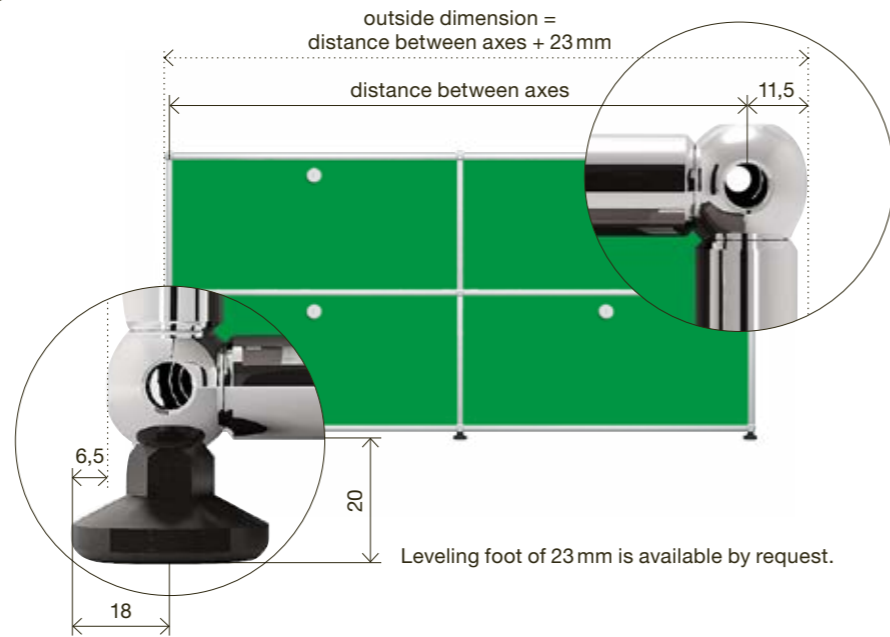

All measurements in mm.

Panels

- 1 Metal panel
- 2 Glass panel
- 3 Acoustic panel
- 4 Perforated metal panel*

Doors

- 5 Metal flip-up door*
- 6 Glass door
- 7 Acoustic drop-down door*
- 8 Metal drop-down door
- 9 Metal extension door*

Shelves and drawers

- 10 Metal divider shelf
- 11 Glass divider shelf
- 12 Metal extension shelf
- 13 Metal angled shelf
- 14 Extension filing set with extension shelf
- 15 Small drawer D: 500
- 16 A6 drawer D: 500
- 17 A5 drawer D: 500
- 18 A4 drawer D: 500
- 19 Metal plant panel with circular recesses to hold the pots

Accessories

- 20 Hanging file baskets
- 21 Metal box insert
- 21a Slide profile for metal box insert
- 22 Cable cut-out
- 23 Metal, magnetic bookend
- 24 USM Inos Box
- 25 USM Inos DVD tray
- 26 USM Inos CD tray
- 27 USM Inos angled file trays
- 28 USM Inos card box set
- 29 Bookend for bookshelf panel (D: 350)
- 30 USM Inos C4 box set, open
- 31 USM Inos C4 box set, closed
- 32 USM Inos drawer organizer set



Start configuring your individual piece of USM now! www.usm.com

Illustration: USM Haller in D: 500 mm.

*Acoustic version available. All measurements in mm.

USM Haller E

A modular structure of your design, either completely or partially equipped with e-Balls and e-Tubes, is connected to a source of electricity. The structure itself conducts the low voltage electricity to the desired location using the e-Balls, e-Connectors and e-Tubes to form a circuit. USB chargers or light sources can be snapped into place in pre-cut recesses. The power supply is drawn from any point near the ground. The power supply cable is attached to a Haller e-Ball, and the power adapter is subsequently tucked underneath the furniture until only the operating switch remains visible. From this point the power supply requires no further cables but rather is integrated into the structure of the furniture.

Application Options

- 1 **Glass Panel**
Glass elements can be illuminated throughout.
- 2 **Without Metal Paneling**
Compartments without metal paneling can be completely illuminated.
- 3 **With Metal Paneling**
Compartments with metal paneling can be illuminated from the front.
- 4 **Compartment with an Extension Shelf**
The entire compartment with an extension shelf can be illuminated.
- 5 **Drop-Down and Extension Door**
Via the "Light When Compartment Is Open" function, the light automatically turns on when the door is opened.
- 6 **Angled Shelf**
The presentation space is illuminated from the front.
- 7 **Floor Lighting**
With floor lighting, the light shines at a 25-degree angle under the furniture.
- 8 **Ambient Lighting**
The light is directed vertically towards the back, illuminating the surroundings with a warm glow.
- 9 **e-USB Charger**
It can be integrated in the same places as the e-Lights.

e-Elements

- 1 **e-Lights**
Dimmable, available in
– Warm white 2700 Kelvin
– Cold white 5700 Kelvin
Both with or without the "light at compartment opening" function.
- 2 **e-USB Charger**
Provides a voltage of 5 volts to the connected device. (Capacity: 6.5 W)
- 3 **e-Dummy**
Sleek, black e-Dummy element close recesses that are still unutilised. If a piece of furniture should later be supplemented with additional light, using e-Tubes (consuming), which are first equipped with e-Dummy elements, is recommended.
- 4 **e-Tube (power outlet)**
Tubes with recesses for e-Lights, e-USB chargers or e-Dummy elements that can be easily snapped into place or replaced.
L 350, 1 recess
L 500, 2 recesses
L 750, 3 recesses
- 5 **e-Tube (conductive)**
The conductive e-Tube serves to conduct the electricity if no inserts are desired in this location. It is available in lengths of 750, 500, 395, 350, 250 and 175 mm.
- 6 **e-Ball, e-Connector**
To enable the flow of electricity, the ball and connector were refined. The exterior dimensions remain unchanged. The distinguishing feature of the ball is the black insulation ring.
- 7 **e-Power Supply**
Includes dimmer at the operating switch. Transforms the power supply voltage to 24 volts. (Capacity: 60 W)
CE
Engineered & Made in Switzerland.
Only available in certain countries. Please contact USM Switzerland for availability in your country.



GERMAN DESIGN AWARD WINNER 2019

Winner of the German Design Award 2019 for outstanding design quality in the Office Furniture category



Winner of the Wallpaper® Design Awards 2018



Winner of the Focus Gold Award 2018 for outstanding design quality



Winner of the Muuz International Award 2018 in the furniture category



Winner of the FX Design Awards, Lighting Product 2017



USM Haller Table

The USM Haller classic and USM Haller Plus Desk can be equipped with an optional cable basket, while the USM Haller Advanced features integrated smart solutions for electrification. All desks can be equipped with grommet hatches for network access.

Basic table
Optional cable basket underneath the tabletop



USM Haller Classic

H: 740
L: 3000 / D: 1000
L: 3000 / D: 750
L: 2500 / D: 1000
L: 2500 / D: 750
L: 2250 / D: 1000
L: 2250 / D: 750
L: 1000 / D: 1000
L: 750 / D: 750
L: 1250 / D: 500**
L: 1500 / D: 500**

H: 740 or 680-860*
L: 2000 / D: 1000
L: 2000 / D: 750
L: 1750 / D: 1000
L: 1750 / D: 750
L: 1500 / D: 1000
L: 1500 / D: 750
L: 1250 / D: 750

Sliding tabletop + adaptation points
Integrated cable tray accessible from above by sliding back the tabletop
Adaptation points for accessories



USM Haller Advanced

H: 740 or 680-860*
L: 2000 / D: 1000
L: 2000 / D: 750
L: 1750 / D: 1000
L: 1750 / D: 750
L: 1500 / D: 1000
L: 1500 / D: 750
L: 1250 / D: 750

Working desk
Optional cable basket underneath the tabletop
Removable adaptation points for accessories



USM Haller Plus

H: 740
L: 3000 / D: 1000
L: 3000 / D: 750

H: 740 or 680-860*
L: 2000 / D: 1000
L: 2000 / D: 750
L: 1750 / D: 1000
L: 1750 / D: 750
L: 1500 / D: 1000
L: 1500 / D: 750
L: 1250 / D: 750

Occasional table



USM Haller occasional table, square

H: 370
L: 3000 / D: 1000
L: 3000 / D: 750
L: 2500 / D: 1000
L: 2500 / D: 750
L: 2250 / D: 1000
L: 2250 / D: 750
L: 2000 / D: 1000
L: 2000 / D: 750
L: 1750 / D: 1000
L: 1750 / D: 750
L: 1500 / D: 1000
L: 1500 / D: 750
L: 1000 / D: 1000
L: 750 / D: 750

* Manual height adjustment with a removable handle.

** Note: These sizes are not yet included in the standard range.

All measurements in mm.

Accessories for all USM Haller Desks

- 1 **Grommet hatch for network access**
Hatch for a single power outlet, flushmounted in tabletop. This unit can be mounted in two different positions on the tabletop. Please specify which position you want when ordering.
- 2 **Cable management**
For the Advanced table type, a cable tray integrated under the tabletop offers storage room and attachment options for all cables and technical components. For the USM Haller Plus, a cable wire basket can be attached.
- 3 **CPU holder**
Computers in various sizes can be mounted using a simple holding device under the table.
- 4 **Link chain**
Holds and directs cables to the power source. Flexible and adjustable to various lengths.
- 5 **Flat screen support arm**
Screens are mounted onto the support arm (VESA standard). Swivel-type with a spherical joint for the screen. Mounting at different heights is possible for screens weighing up to 12 kg.
- 6 **Flat screen pivot arm**
Screens are screwed to the height adjustable pivot arm using a mounting plate (VESA standard). Continuous height adjustment for screens weighing up to 12 kg.
- 7 **Front and side panel**
Can be attached under the table to the long side or laterally. For tables with lengths: 2000, 1750, 1500, 1250 and depths: 1000, 750.
- 8 **Pivoting pen holder**
Provides room for writing instruments and can be discreetly stowed under the tabletop.
- 9 **USM Privacy Panels**
Can be attached to the long side to ensure individuality and privacy for people working at tables configured as a cluster. H: 350 or H: 700. For tables with lengths: 3000, 2000, 1750, 1500.
- 10 **Handle**
With slip clutch for synchronous height-adjustment (optional).

Accessories for USM Haller Desk Plus/ Advanced

- 11 **Flat screen support bar**
The support bar is inserted into the adaptation points. Up to two screens (max. 2 x 12 kg) can be attached using a mounting plate (VESA standard). Screens can be mounted at different heights; screens can be adjusted with ball joints. Continuously height-adjustable for screens weighing up to 12 kg.
 - 12 **USB adapter**
The adapter is suitable for USB 2.0 and 3.0 ports. It can easily be inserted into the adaptation point. Usable as power supply or for data transfer.
 - 13 **Lamp peg**
An optional lamp peg for easy attachment of selected table lamps. Electrification is possible through the adaptation point.
- Options
- 11a **Flat screen support bar fix**
 - 11b **Flat screen support bar adjustable**
Move forwards or backwards two notches at a time to adjust the viewing distance.



All measurements in mm.

USM Kitos M and E Desk

Each desk (except free-standing) of the USM Kitos M and E family offers integrated smart solutions for electrification.

Why USM Kitos M?

The "M" in its name stands for mechanical spring-loaded height adjustment; adjustment time approx. 1 second with zero energy consumption. This system is more than 10 times faster than the electronic equivalent and has an extremely long operating life.

Why USM Kitos E?

Maximum functionality and captivating design – USM Kitos E unites all requirements in one modern workplace: continuous height adjustability and maximum stability. A distinction is made between fixed and motor-driven legs in the E1, E2 and E3 models.

E1



H: 740
With or without middle traverse

E2 with 1 motor



H: 700–1200
Adjustment time approx. 30 sec.
With middle traverse

E3 with 2 motors



H: 650–1300
Adjustment time approx. 20 sec.
With middle traverse

Basic desk

Integrated cable tray underneath the tabletop



USM Kitos M

H: 700–1200
L: 1800 / D: 900
L: 1750 / D: 750
L: 1600 / D: 800

USM Kitos E

L: 1800 / D: 900
L: 1750 / D: 750
L: 1600 / D: 800
Available with E1*, E2 or E3** columns

Sliding tabletop

Integrated cable tray accessible from above by sliding back the tabletop

Adaptation points for accessories



USM Kitos M Plus

H: 700–1200
L: 1800 / D: 900
L: 1750 / D: 750
L: 1600 / D: 800

USM Kitos E Plus

L: 1800 / D: 900
L: 1750 / D: 750
L: 1600 / D: 800
Available with E1*, E2 or E3 columns

Extra size

Integrated cable tray underneath the tabletop and accessible from all sides



USM Kitos M Meeting

H: 700–1150
L: 2500 / D: 1000
L: 2250 / D: 1000

USM Kitos E Meeting

L: 2500 / D: 1250
L: 2500 / D: 1000
L: 2250 / D: 1000
Available with E1, E2 or E3 columns

Side table



USM Kitos E Free-standing

H: 740 or 700 – 1110
Square
L: 750 and 900
Round
Ø: 900 and 1100

The table can also be provided with an asymmetrical version of the middle traverse, for extra legroom. (This is not possible with the USM Kitos E / M Meeting.)

* Available with or without middle traverse.

** Available in a GS-Mark tested version with 3 mm table edge radius and the asymmetrical middle traverse.

All measurements in mm.

Accessories for all USM Kitos M and E Desks

- Grommet hatch for network access**
Hatch for a single power outlet, flush-mounted in table-top. This unit can be mounted in two different positions on the tabletop.

- CPU holder**
The CPU holder allows computers of various sizes to be mounted either under the tabletop facing outwards or on the middle traverse facing outwards or inwards as desired.

- Link chain**
Holds and directs cables to the power source.

- USM Privacy Panels**
Can be attached to the long side to ensure individuality and privacy for people working at tables configured as a cluster.
H: 350 or 700. For tables with lengths: 2500, 2250, 1800, 1750, 1600.

Accessories for all USM Kitos M and E Desks, except USM Kitos M Meeting / E Meeting

- Flat screen pivot arm**
Screens are screwed to the height adjustable pivot arm using a mounting plate (VESA standard). Available for USM Kitos E and M tables: the pivot arm is mounted onto the tabletop using the universal support. Available for USM Kitos M and E Plus: The pivot arm can be inserted into one of the adaptation points with a tube set. Continuous height adjustment for screens weighing up to 12 kg.

- Front panel**
Can be attached under the table to the long side or laterally. For tables with lengths: 1800, 1750, 1600.
- Material tray**
Provides room for writing instruments and can be discreetly stowed under the tabletop.

Accessories for USM Kitos M Plus / E Plus

- Flat screen support arm**
Screens are mounted onto the support arm (VESA standard) which can be connected directly to one of the adaptation points. Swivel-type with a spherical joint for the screen. Mounting at different heights is possible for screens weighing up to 12 kg.
- Flat screen support bar**
The bracket is inserted into the adaptation points. Up to two screens (max. 2 x 12 kg) can be attached using a mounting plate (VESA standard). Screens can be mounted at different heights; screens can be adjusted with ball joints.

- Options:
- Flat screen support bar fix**
 - Flat screen support bar adjustable**
Move forwards or backwards two notches at a time to adjust the viewing distance.
 - USB adapter**
The adapter is suitable for USB 2.0 and 3.0 ports. It can easily be inserted into the adaptation point. Usable as power supply or for data transfer.
 - Lamp peg**
An optional lamp peg for easy attachment of selected table lamps. Electrification is possible through the adaptation point.

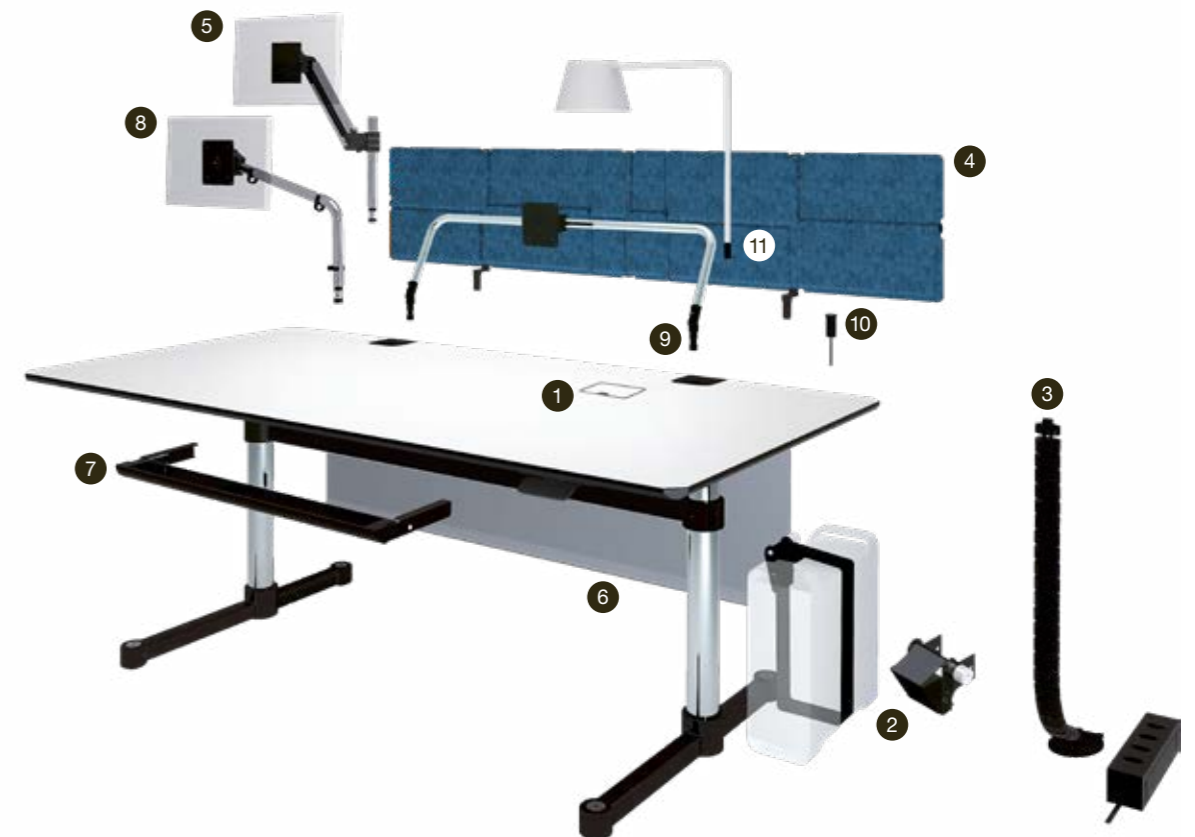

All measurements in mm.

Accessories



1



2

1 Metal, magnetic bookend
Available in light gray and graphite black.

2 Material tray
Provides room for writing instruments and can be discreetly stowed under the tabletop.

3 USM Inos internal organisation
Plastic box in metal frame: Perfect for keeping small bits and pieces organized – be it in your home office or anywhere else in your house.

4 USM Inos C4 box set
Thanks to its dimensions, the Inos box set fits into any piece of USM furniture. Available in light grey and graphite black.

Closed 5- or 10-drawer C4 box sets are also available in USM ruby red, pure white, golden yellow, green and beige.

5 USM Inos Box
The new USM Inos Boxes organise, store and protect both your treasures and everyday paraphernalia of life. Several boxes can be stacked on top of each other with the help of trays, which can also be used as covers or serving trays, or to hold assorted small items around the home. These soft storage boxes made of nonwoven polyester are available in four different sizes and in light gray and anthracite gray.

6 World of plants for a healthy climate
Plants improve the indoor climate and thus our working environment. With USM's worlds of plants, lively ever-green landscapes can now be easily integrated into the structure of USM Haller.



6



3



4

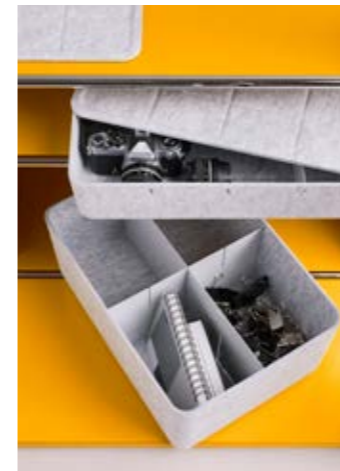

5



Colours & surfaces

USM Haller



Metal



USM Haller and USM Kitos Tables



Powder-coated MDF

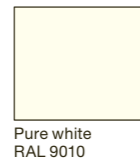

Pure white
RAL 9010

Trans-parent glass

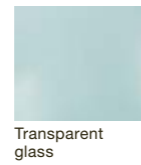

Transparent
glass

Linoleum

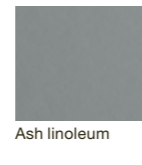

Ash linoleum

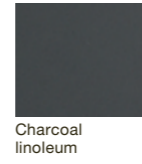

Charcoal
linoleum

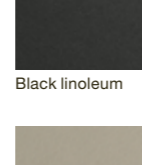

Black linoleum

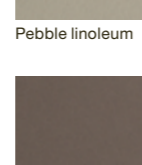

Pebble linoleum



Mauve linoleum

Laminate

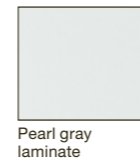

Pearl gray
laminate

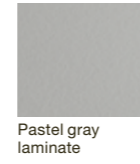

Pastel gray
laminate

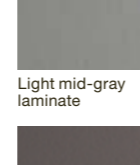

Light mid-gray
laminate

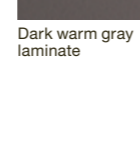

Dark warm gray
laminate

Fenix

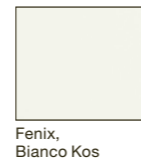

Fenix,
Bianco Kos



Fenix,
Grigio Londra

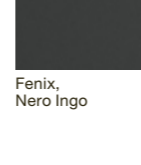

Fenix,
Nero Ingo

Oiled or lacquered veneer

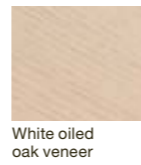

White oiled
oak veneer

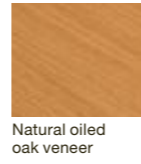

Natural oiled
oak veneer

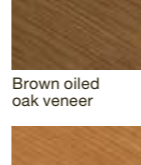

Brown oiled
oak veneer

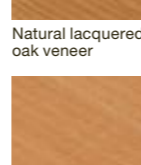

Natural lacquered
oak veneer

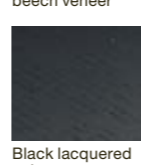

Natural lacquered
beech veneer



Black lacquered
oak veneer

USM Privacy Panels



Fabric panel

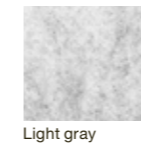

Light gray



Anthracite

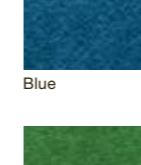

Blue

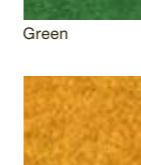

Green



Yellow

USM Inos C4 box set



Metal



Pure white
RAL 9010



Light gray
RAL 7035

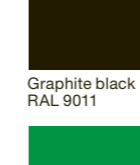

Graphite black
RAL 9011

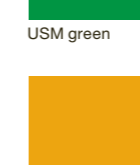

USM green

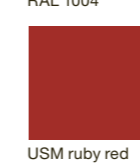

Golden yellow
RAL 1004



USM ruby red



USM beige

USM Pots



Clay



Terracotta

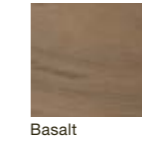

Basalt

Details

USM Haller



Metal

USM Haller Table



Powder-coated MDF

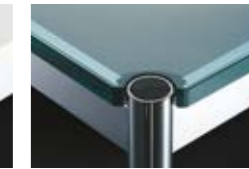

Transparent glass



Linoleum

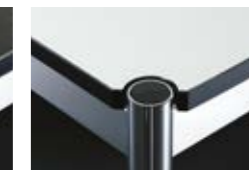

Laminate



Fenix



Oiled or lacquered veneer

USM Kitos Table



Powder-coated MDF



Transparent glass



Linoleum



Laminate



Fenix

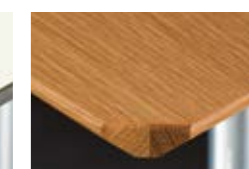

Oiled or lacquered veneer

Other colours and surfaces available upon request. Prices and delivery times of table surfaces upon request.

The tabletop in glass is only available for USM Haller Desks up to L: 2000 mm and all USM Kitos Desks with a fixed height (H: 740 mm) or stepwise height adjustment and continuous height adjustment (H: 680 - 780 / 1060 mm).

Switzerland

USM U. Schärer Söhne AG
Thunstrasse 55, 3110 Münsingen
Phone +41 31 720 72 72, info.ch@usm.com

Germany

USM U. Schärer Söhne GmbH
Siemensstraße 4a, 77815 Bühl
Phone +49 7223 80 94 0, info.de@usm.com

France

USM U. Schärer Fils SA, Showroom
23, rue de Bourgogne, 75007 Paris
Phone +33 1 53 59 30 37, info.fr@usm.com

United Kingdom

USM U. Schaerer Sons Ltd., London Showroom
Ground Floor, 49–51 Central St., London, EC1V 8AB
Phone +44 207 183 3470, info.uk@usm.com

USA

USM U. Schaerer Sons Inc., New York Showroom
28–30 Greene Street, New York, NY 10013
Phone +1 212 371 1230, info.us@usm.com

Japan

USM U. Schaerer Sons K.K., Tokyo Showroom
Marunouchi MY PLAZA 1 · 2F
2-1-1 Marunouchi, Chiyoda-ku, Tokyo 100-0005
Phone +81 3 5220 2221, info.jp@usm.com

All other countries

contact USM Switzerland.

www.usm.com