

Microsurf White

Neil Poulton

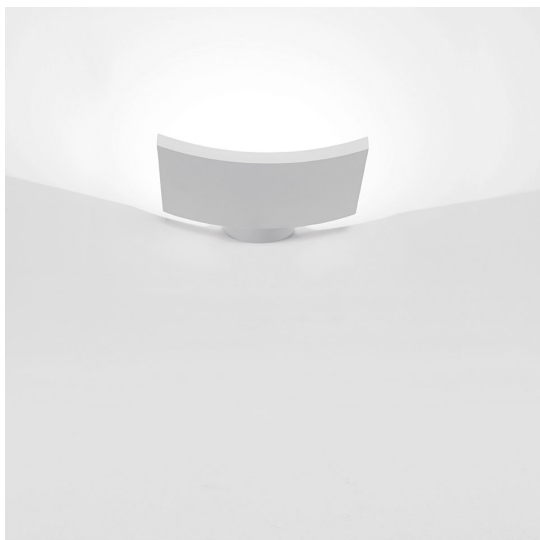

IP20    

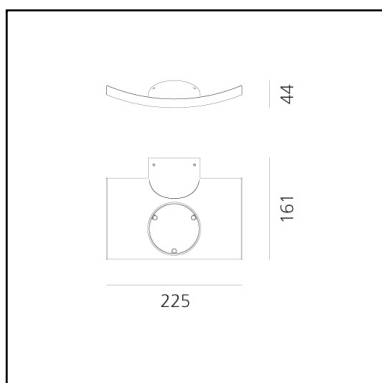

LUMINAIRE

- Watt: **20W**
- Voltage: **220 - 240 V**
- Delivered lumens output: **1826lm**
- CCT: **3000K**
- Efficiency: **97%**
- Efficacy: **91.28lm/W**
- CRI: **82**

DESCRIPTION

A minimal, almost unobtrusive design to be integrated into any architectural setting. Materials: die-cast painted aluminium.

PRODUCT CODE: 1646010A

FEATURES

- Article Code: **1646010A**
- Colour: **White**
- Installation: **Wall**
- Material: **Aluminium**
- Series: **Design Collection**
- Environment: **Indoor**
- Emission: **Indirect**
- design by: **Neil Poulton**

DIMENSIONS

- Length: **cm 20**
- Width: **cm 15**
- Height: **cm 4**
- Glow Wire Test: **850°**

SOURCES INCLUDED

- Category: **Led**
- Number: **1**
- Watt: **20W**
- Color temperature (K): **3000K**