

ZETR

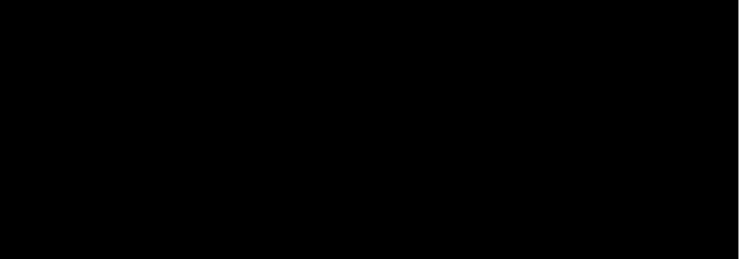



[TOP TO BOTTOM]

FINISHES: BR5 / BZ9 / SS8 / BS7

PORTS: HDMI / USB-A / DATA / USB-C

SPECIFICATIONS



PRODUCT

25 - Power and Data System, 3 Sizes

FEATURES

Single action connectivity
Produced in high quality materials and finishes
Fast charging for high-output devices
Designed for ease of maintenance and serviceability

MATERIALS

Faceplate - Stainless Steel
Mechanism Grid - Stainless Steel
Undercarriage - Stainless Steel

NO. OF PORTS / CODE

2 Port / 2P
4 Port / 4P
8 Port / 8P

PORT - CODE

USB-C - C
USB-A - A
HDMI - H
DATA - D

FINISH - CODE

Brass - BR5
Bronze - BZ9
Steel - SS8
Black Steel - BS7

POWER OPTIONS / CODE

Double Power Supply [MAX. 170W] / DPS
Double Power Supply [MAX. 340W] / QPS

ORDER GUIDE

- Select No. of Ports
- Select Port Type [Multiple selection required depending on port no. selected in previous step]
- Select Faceplate Finish
- Select Optional Power Upgrade

i.e.

25 - 8P - CCCAHDDD - BR5 / QPS

SERIES NO.	NO. OF PORTS	PORT TYPE	FACEPLATE FINISH	OPTIONAL POWER
25	8P	CCCAHDDD	BR5	QPS

2P

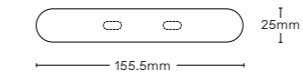

4P

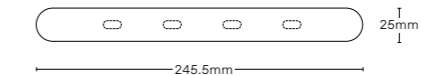

8P



SYSTEM

- 1 FACEPLATE
- 2 MECHANISM GRID
- 3 SUBSTRATE
- 4 UNDERCARRIAGE

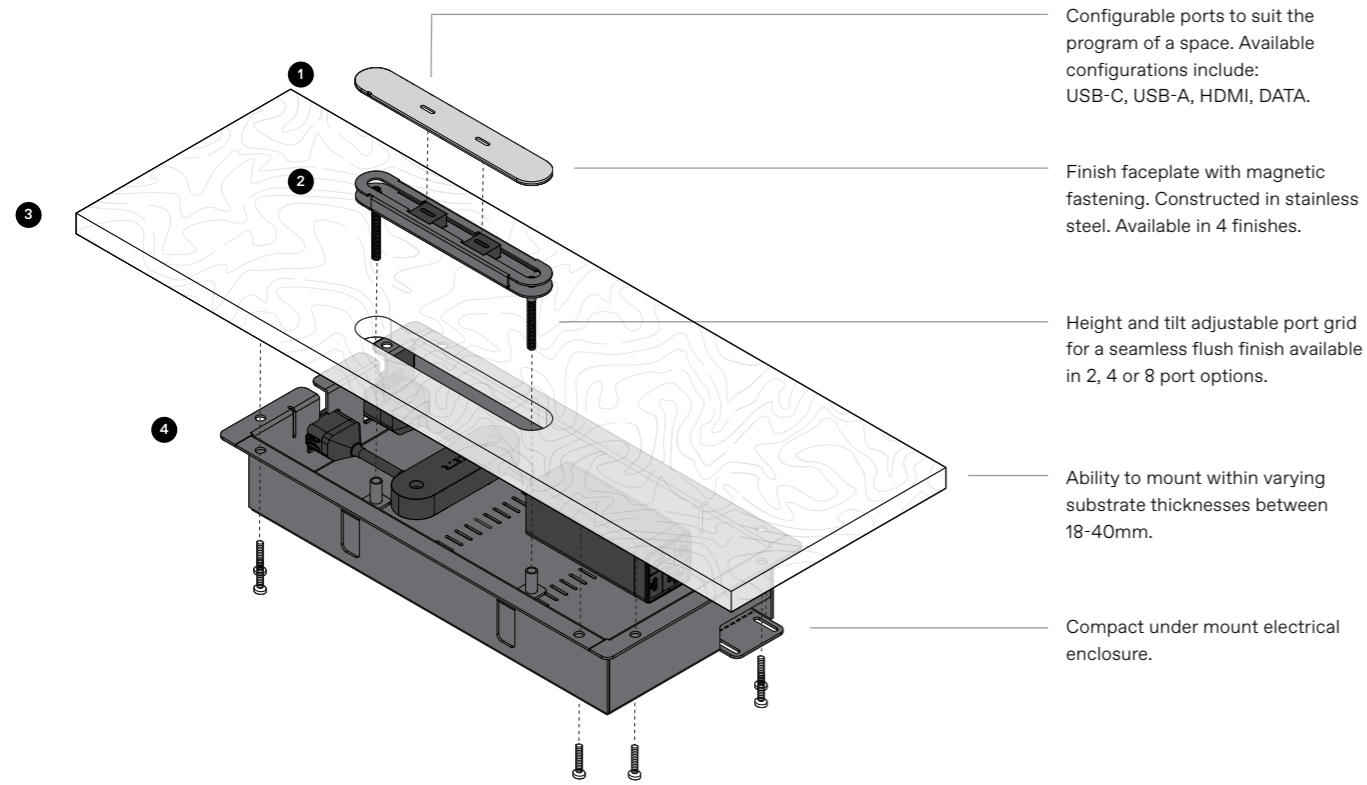

DIMENSIONS

2 PORT [25-2P]

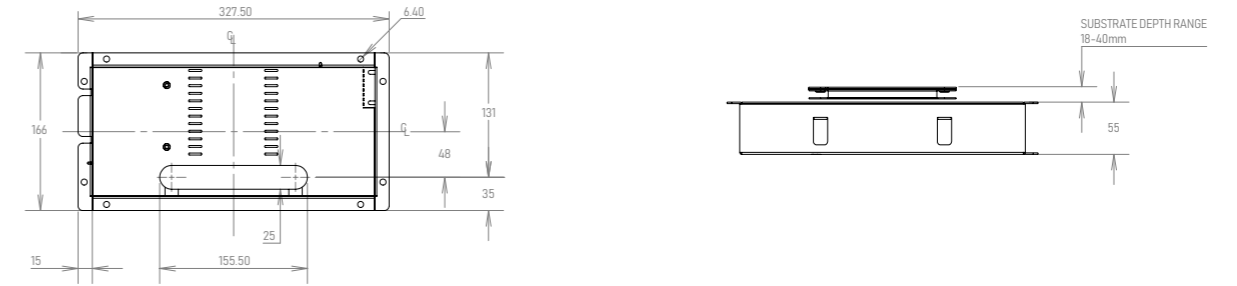

4 PORT COMPACT [25-4PC]

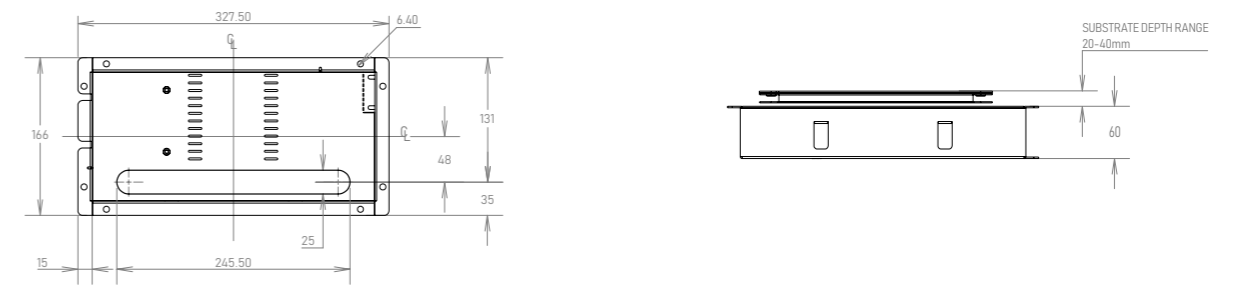

4 PORT [25-4P]

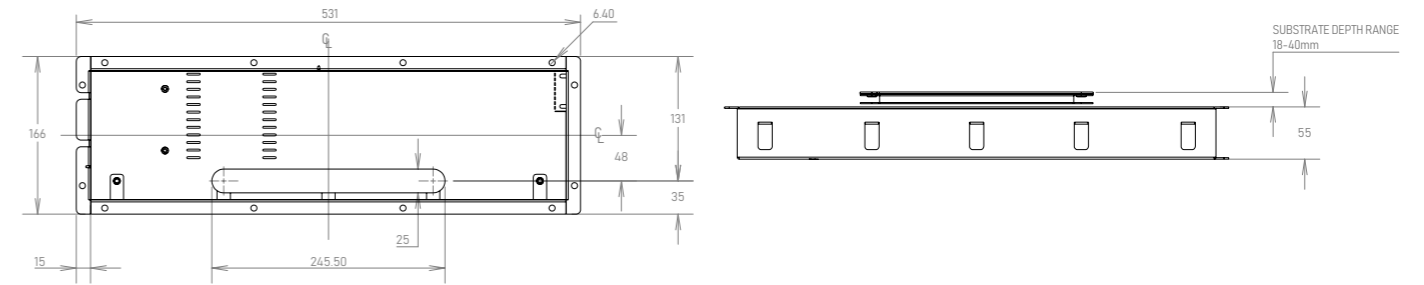

8 PORT [25-8P]

