



Struttura: telaio superiore e appoggio a terra in tubolare di acciaio inox verniciato color Bronzo con finitura lucida anti-touch.

La struttura in acciaio è rivestita da un filato di polipropilene intrecciato, che forma un nastro di mm 24x7.

Il filato è disponibile nei colori Ecru e Bronzo.

Cornice in massello di teak (Tectona Grandis - First European Quality), finitura naturale, spessore 60 mm, stabilizzato in forni di essiccazione.

Lavorazione eseguita su macchina a controllo numerico, assemblaggio a 45° con incastri a pettine e bloccaggio tramite spinature.

Il daybed con schienale reclinabile ha un telaio in acciaio inox verniciato color Bronzo con finitura lucida anti-touch, rivestito con tessuto Batyline.

Cuscineria: cuscini sedile e schienale in poliuretano espanso ad alta resilienza e fibra idrorepellente ecocompatibile.

Al fine di migliorare la protezione delle imbottiture da acqua e umidità, tutti i cuscini sono rivestiti con una fodera in poliesteri con trattamento idrorepellente.

Tutti gli accessori utilizzati per la confezione - cerniere, filo - sono idrorepellenti e pertanto idonei all'utilizzo outdoor.

Sfoderabilità: il rivestimento dei cuscini è completamente sfoderabile. Scivolante protettivo in polietilene di colore Bronzo.

TAVOLINI

Struttura: tubolare di acciaio inox verniciato color Bronzo con finitura lucida anti-touch.

Piano: in massello di teak (Tectona Grandis - First European Quality), finitura naturale, spessore 60 mm, stabilizzato in forni di essiccazione. Lavorazione eseguita su macchina a controllo numerico, assemblaggio a 45° con incastri a pettine e bloccaggio tramite spinature.

Scivolante protettivo in polietilene di colore Bronzo.

Structure: upper frame and legs in tubular stainless steel varnished Bronze colour with polished anti-fingerprint finish.

The steel structure is clad in woven polypropylene fiber that forms a 24x7 mm strip. The woven fiber comes in Ecru and Bronze colours.

Frame in 60 mm thick solid teak (Tectona Grandis - First European Quality), natural finish, kiln-dried. Crafted on CNC machines, assembled at 45° with finger joints reinforced with dowel pins.

The daybed with reclinable backrest has a stainless steel frame varnished Bronze colour with glossy anti-fingerprint finish, upholstered in Batyline fabric.

Cushions: seat and backrest cushions in high-resilience polyurethane foam and eco-friendly, water-repellent fiber.

In order to better protect the padding from water and humidity, all the cushions have a water repellent polyester cover. All the accessories - zips, yarn - are water repellent and therefore suitable for outdoor use.

Covers: completely removable cushion covers. Bronze colour protective polyethylene glides.

COFFEE TABLES

Structure: in tubular stainless steel varnished Bronze colour with polished anti-fingerprint finish.

Top: in 60 mm thick solid teak (Tectona Grandis - First European Quality), natural finish, kiln-dried. Crafted on CNC machines, assembled at 45° with finger joints reinforced with dowel pins.

Bronze colour protective polyethylene glides.

Gestell: Obergestell und Untergestell aus Edelstahlrohr mit Lackierung in der Farbe Bronze mit glänzender Anti-Touch Oberfläche. Das Stahlgestell ist mit einem geflochtenen Propylengarn bezogen, das ein 24x7 mm großes Band formt. Das Garn ist in den Farben Ecru und Bronze verfügbar.

Rahmen aus massivem Teakholz (Tectona Grandis - First European Quality) mit naturbelassener Oberfläche, Stärke 60 mm, im Trocknungssofen stabilisiert.

Die Verarbeitung erfolgt auf Maschinen mit CNC-Steuerung und Zusammenbau im 45°-Winkel mit Fingerzinken und Blockierung über Dübelverbindungen.

Das Daybed mit verstellbarer Rückenlehne hat Edelstahlrahmen mit Lackierung in der Farbe Bronze mit glänzender Anti-Touch Oberfläche und Batyline Stoffbezug.

Kissen: Sitzkissen und Rückenissen aus hochwiderstandsfähigem PU-Schaum und umweltfreundlicher, wasserabweisender Faser.

Zum Schutz der Polsterung vor Wasser und Feuchtigkeit verfügen alle Kissen über einen Polyesterbezug mit wasserabweisender Behandlung.

Alle für die Konfektionierung verwendeten Accessoires (Reißverschlüsse, Garn) sind wasserabweisend und daher für den Outdoor-Bereich geeignet.

Abziehbarkeit: Die Kissenbezüge sind komplett abziehbar. Schutzgleiter aus Polyethylen in der Farbe Bronze.

BEISTELLTISCHE

Gestell: aus Edelstahlrohr mit Lackierung in der Farbe Bronze mit glänzender Anti-Touch Oberfläche.

Platte: aus massivem Teakholz (Tectona Grandis - First European Quality) mit naturbelassener Oberfläche, Stärke 60 mm, im Trocknungssofen stabilisiert.

Die Verarbeitung erfolgt auf Maschinen mit CNC-Steuerung und Zusammenbau im 45°-Winkel mit Fingerzinken und Blockierung über Dübelverbindungen.

Schutzgleiter aus Polyethylen in der Farbe Bronze.

Structure: châssis supérieur et piètement en tubes d'acier inox laqué de couleur Bronze finition brillante anti-traces de doigt.

La structure en acier est recouverte d'un fil de polypropylène tressé qui forme un ruban de 24x7 mm.

Le fil est disponible dans les couleurs Ecru et Bronze.

Cadre en teck massif (Tectona Grandis - First European Quality), finition naturelle, 60 mm d'épaisseur, stabilisé dans des fours de séchage.

Usinage réalisé sur des machines à commande numérique, assemblage à 45° à queues droites et fixation par tourillons.

Le lit de repos avec dossier inclinable a un châssis en acier inox laqué de couleur Bronze finition brillante anti-traces de doigt, recouvert de tissu Batyline.

Coussins: coussins d'assise et de dossier en polyuréthane expansé haute résilience et viscofibre hydrofuge écologique.

Afin d'améliorer la protection des rembourrages contre l'eau et l'humidité, tous les coussins sont recouverts d'une housse en polyester avec traitement déperlant.

Tous les accessoires utilisés pour la confection - fermetures à glissière, fil - sont hydrofuges et donc adaptés à une utilisation en extérieur.

Déhoussage: le revêtement des coussins est entièrement déhoussable.

Patins glisseurs en polyéthylène de couleur Bronze.

PETITES TABLES

Structure: en tubes d'acier inox laqué de couleur Bronze finition brillante anti-traces de doigt.

Plateau: en teck massif (Tectona Grandis - First European Quality), finition naturelle, 60 mm d'épaisseur, stabilisé dans des fours de séchage.

Usinage réalisé sur des machines à commande numérique, assemblage à 45° à queues droites et fixation par tourillons.

Patins glisseurs en polyéthylène de couleur Bronze.

TAVOLINI | COFFEE TABLES

STRUTTURA E GAMBE STRUCTURE AND LEGS

ACCIAIO INOX STAINLESS STEEL

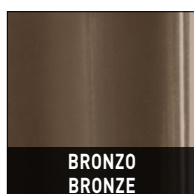

BRONZO
BRONZE

RIVESTIMENTO STRUTTURA STRUCTURE COVER

FILATO IN POLIPROPILENE POLYPROPYLENE FIBER

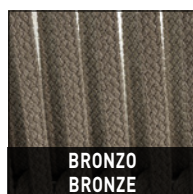

BRONZO
BRONZE



ECRU

BASE BASE

TEAK

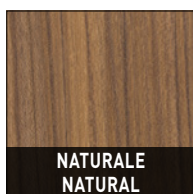

NATURALE
NATURAL

PIANO TOP

TEAK

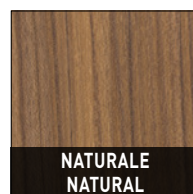

NATURALE
NATURAL

GAMBE LEGS

ACCIAIO INOX STAINLESS STEEL

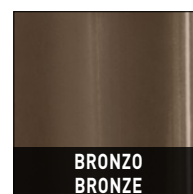

BRONZO
BRONZE

Minotti

ELEMENTO TERMINALE CON **TOP SMALL CM 248**
ELEMENT WITH 1 ARMREST AND **TOP SMALL CM 248**

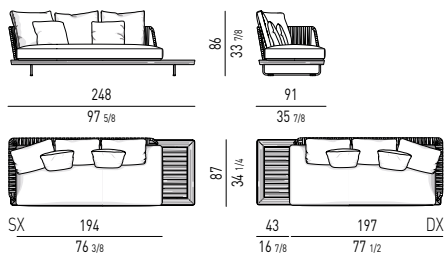

ELEMENTO TERMINALE CON **TOP LARGE CM 248**
ELEMENT WITH 1 ARMREST AND **TOP LARGE CM 248**

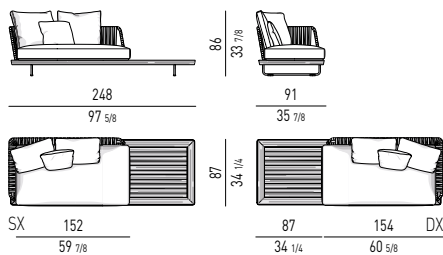

CHAISE-LONGUE

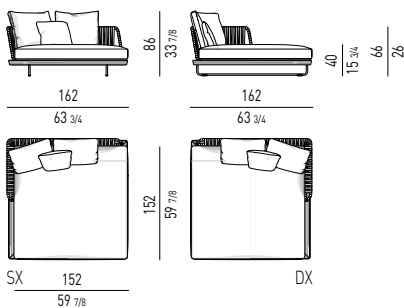

LOVESEAT

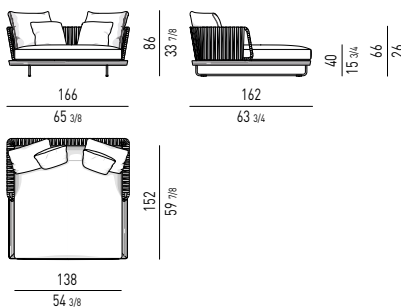

DAYBED CON SCHIENALE RECLINABILE | DAYBED WITH RECLINING BACKREST

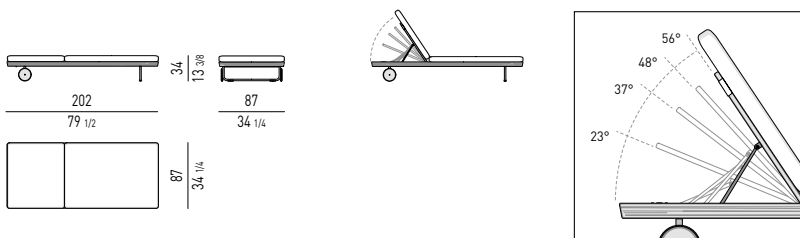

CUSCINO SCHIENALE OPTIONAL OPTIONAL BACKREST CUSHION

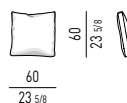

CUSCINO OPTIONAL OPTIONAL CUSHION

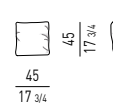

TAVOLINI | COFFEE TABLES

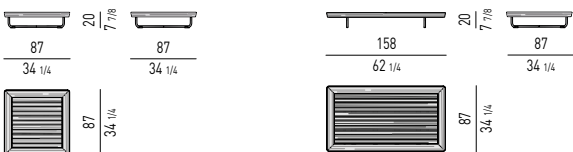

OPTIONAL RAIN COVER

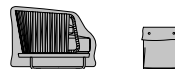

Disponibile per ogni elemento
Available for each element



LA BASE STRUTTURALE IN LEGNO MASSELLO DI TEAK, SU CUI POGGIA LA CUSCINATURA, È RIFINITA CON GRANDE CURA.

GREAT CARE WAS TAKEN IN THE REFINEMENT OF THE STRUCTURAL BASE IN SOLID TEAK WOOD, ON WHICH THE CUSHIONS REST.



Inventory Transfer - 41162

Date 08/28/2023

Time 09:02

Customer ECC Ltd Use for Internal Transfers Only Sales Employee Victoria Tilley
Address , Default Price List 1_Retail
From warehouse AWH

#	Item No.	Description	To Whse	UoM	Qty	Item Cost	Price
1	RO00020102	Orson Director Lounge Chair Teak & Sand	KSL	Ea	2.00		
2	RO100711	Piper 007 Sunlounger Smoke Frame & G	KSL	Ea	1.00		
3	RY505004N	Palma Umbrella Black Coated Aluminium	KSL	Ea	1.00		
4	RY943200	Conix Table Oval 320x140 Concrete h75C	KSL	Ea	1.00		
5	RY702001	Styletto Chair White 55x59 h76 Seat h44C	KSL	Ea	6.00		
6	RO70340201	Spinnaker 034 Extendable Table Milk & T	KSL	Ea	1.00		
7	RY690000	Strappy Armchair Bronze Frame & Natur	KSL	Ea	6.00		
8	RO70460102	Root 046 Side Table Teak With Carrara M	KSL	Ea	1.00		
9	RO70460103	Root 046 Side Table Teak With Farsena T	KSL	Ea	1.00		
10	RO100101060	Laze 001 Lounge Chair Smoke With Olive	KSL	Ea	1.00		
11	RO20010102	Laze 004 Stool Smoke With Olive Cord 6	KSL	Ea	1.00		
12	RO520300	Eden 3 Seater Sofa Teak 285x95 Seat h4	KSL	Ea	1.00		
13	RO720295	Aspic 002 Coffee Table Concrete Ø90 h4	KSL	Ea	1.00		
14	RO720195	Aspic 001 Side Table Concrete Ø40 h45C	KSL	Ea	1.00		
15	RO701013	Piper 010 Table Smoke Metal Frame & F	KSL	Ea	1.00		
16	RO70120103	Piper 012 Table Smoke Metal Frame & F	KSL	Ea	1.00		
17	RO800101	Caddy 001 Bar Trolley Teak Ø60 h79CM	KSL		1.00		
18	WR300200	Twilight Outdoor Lantern M Brushed Stair	KSL	Ea	1.00		
19	WR080333	Maui Rug 300x300CM MI03 Silver	KSL	Ea	1.00		
20	BJ413603	Fora P Floor Lamp Graphite Brown & Rat	KSL	Ea	1.00		
21	BJ413701	Fora M Table Lamp Natural White & Light	KSL	Ea	1.00		
22	RY919576	Tea Time Table Bronze Coated Aluminium	KSL	Ea	1.00		
23	RY506101	Bloom Umbrella White Frame & White Sh	KSL	Ea	1.00		