

Snap Track - Recessed

Datasheet

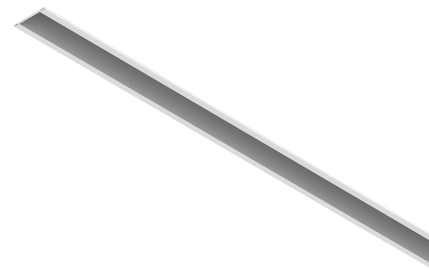

Product Codes

Unit: SR (Snap Recessed)	Length (m): 1 2	Color: B (Black) W (White)
------------------------------------	------------------------------	---

Accessories Codes

Unit: LEC (Live End Connector) LFC (Live Flexible Connector) LSC (Live Straight Connector) EC.AL (Aluminum End Cap)	Snap Type: SS/SP/SR/SRT (Snap Surface / Snap Pendant / Snap Recessed / Snap Recessed Trimless)	Color: B (Black) W (White)
--	--	---

Track Dimensions (mm)

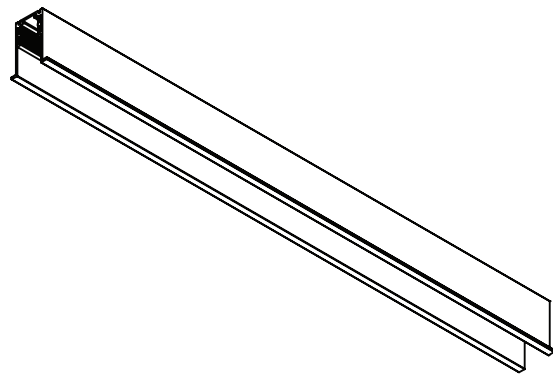
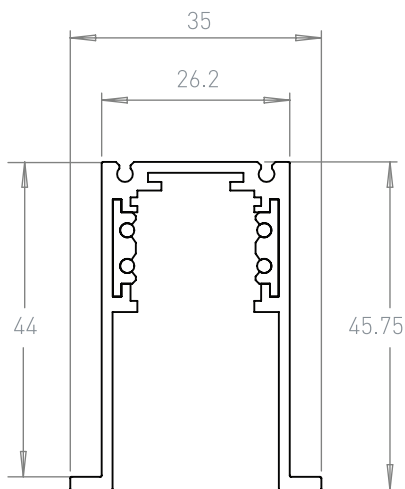

Installation

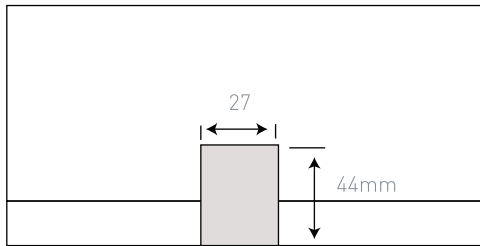

Step 1

Cut 27mm slot 44mm deep. No boxing out required as ceiling joint only has 34mm cut out of it

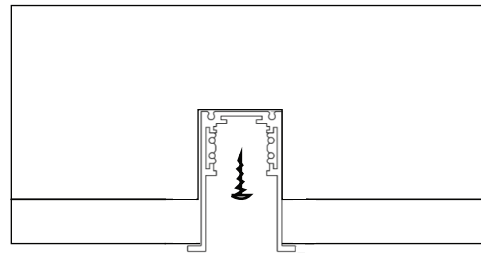

Step 2

Screw Track to ceiling joint.

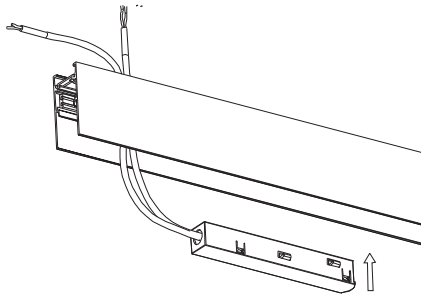

Step 3

Snap Live end connector into track light and thread through rear of the track.

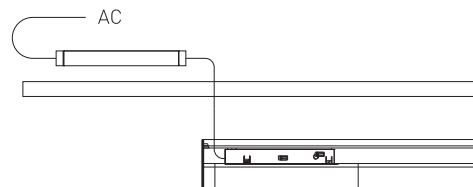

Step 4

Wire cable from end connector into driver.

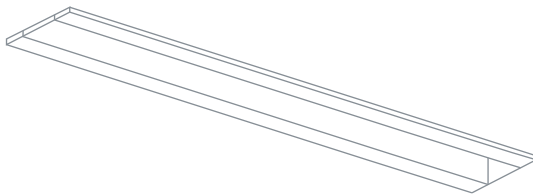

Step 5

Installation Complete.