

MIUNN | S104T

Karri Monni | 2011



MIUNN

Karri Monni | 2011

When minimalism embraces. It involves technology and the 3D processing of a wood sheet. It involves a hand that designs, thinking of itself, of the palm that holds water and sand. The result is the sinuous MIUNN, with its embracing seat and perfect support for the back. Available in a chair or stool version, it comes in different heights. Peacefully, just as it was designed.



| S104T Height-adjustable piston stool with round base H53 ÷ 78

Stool with swivel seat and adjustable height. Frame in sandblasted stainless steel Aisi304 and round base covered by a stainless steel sheet "linen fabric" pattern or entirely powder coated. Seat formed of a single shell using 3D plywood moulding technology in several wood finishes, or in fire-retardant Baydur® polyurethane white or black lacquered or totally upholstered with fabric, leather or eco-leather. Felt under the base.

TEST EN 15373:2007 - L3 severe

TEST 1 IM - Hallingdal

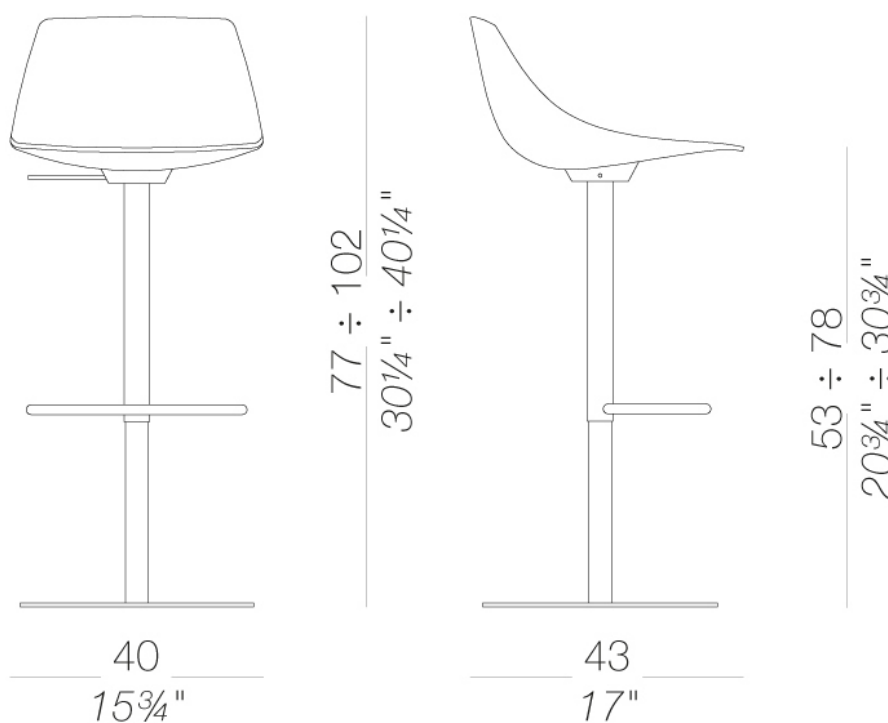

MIUNN | S104T

Karri Monni | 2011

frame



powder coating
black
1 Colors

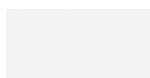

powder coating
white
1 Colors



metal
stainless steel
1 Colors

shell



plastics
Baydur®
2 Colors

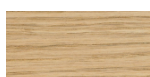

wood
blanch oak
1 Colors

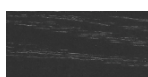

wood
black open pore
1 Colors



wood
oak dark walnut
1 Colors

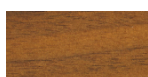

wood
Canaletto walnut
1 Colors

upholstery



fabric
Hallingdal 65 -
Grade C
58 Colors



fabric
Canvas 2 - Grade C
45 Colors



fabric
Steelcut Trio 3 -
Grade D
54 Colors



fabric
Remix 3 - Grade C
72 Colors



fabric
Clara 2 - Grade C
24 Colors



fabric
Fiord 2 - Grade C
39 Colors



fabric
Divina MD - Grade D
27 Colors



fabric
Divina Melange 3 -
Grade D
38 Colors



fabric
Tonica 2 - Grade C
39 Colors



fabric
Medley - Grade A
37 Colors

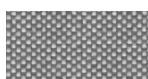

fabric
Maya - Grade A
43 Colors



fabric
Jet - Grade A
66 Colors

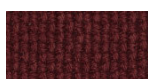

fabric
Lapalma Smart -
Grade C
18 Colors

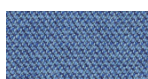

fabric
Capture - Grade B
43 Colors

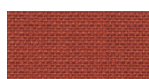

fabric
Crisp - Grade B
40 Colors



fabric
Nattè - Grade B
30 Colors



fabric
Iris - Grade B
24 Colors



fabric
Steelcut 3 - Grade D
40 Colors



leather
Dleather
7 Colors



ecoleather
GRIMM FR - Grade
A
32 Colors

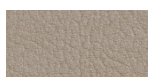

ecoleather
Valencia - Grade B
66 Colors

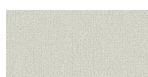

fabric
Grain - Grade. B
50 Colors



fabric
Re-wool - Grade C
21 Colors

consult the portfolio for the range of colors, fabrics, eco-leather, soft-leather.

use and maintenance instructions

Clean all parts in wood, leather, fabric and metal with a damp cloth or a diluted neutral cleaner. Do not use cleaners with alcohol, bleach, solvent or abrasive products. Any liquid spilt on the product must be wiped up immediately. When lifting or moving the product, hold it on the structure and not under the seat. The product should not be subjected to unbalanced weights, as it is designed for a proper rest on the foothold (on four legs or on the base). Our company relieves from any responsibility in case of damage caused to fragile floors. Avoid any improper use of the product: do not step on the product, on the footrest or on the armrests. Avoid any movements that could compromise the proper functionality of the product or the safety of the users. Wood and leather, being natural materials, could be easily damaged. Small impurities or imperfections are within quality standard range. Do not expose the product to weather conditions or atmospheric agents, nor to heat sources over 40°C. Also products for outdoor use could be afflicted by atmospheric agents. The product could undergo possible exterior changes due to particular exposure to heat, humidity and saltiness. An appropriate and frequent maintenance and cleaning of the product enhances its durability. The product could change colour and shade, if exposed to direct sunlight. Maintenance has to be carried out by experienced staff. Dispose of the package only after assembling the product, in order to avoid the loss of ironmongery and components. Once the product has been dismantled, the product itself or its components must be given to the public garbage disposal system, according to the legislation in force.