

G.News

Loll Modular



GERVASONI

1882

A look inside →



Uno sguardo all'interno

Un regard à l'intérieur

Ein Blick hinein

A →
Struttura / Structure /
Structure / Gestell

Struttura in legno massello preparata con poliuretano espanso a quote differenziate, localizzate, ad alta densità, al fine di migliorarne comfort, sofficià e durata. Rivestimento della struttura in fibra termolegata traspirante accoppiata con una maglina elastica bianca che ne conferisce maggior morbidezza. Piedi in polietilene ad alta resistenza, colore nero.

Structure in solid wood made of high resilience, variable-density polyurethane foam, in order to improve comfort, softness and durability. Structure covered with breathable, heat-bonded fiber laminated to white elastic jersey which gives it greater softness. Circular feet in high resistance black polyethylene.

Structure en bois massif associée à du polyuréthane expansé à densité différenciée haute résilience, garantissant confort, souplesse et longévité. Revêtement de la structure en fibre thermocollée respirante, doublée de jersey élastique blanc qui lui confère une plus grande douceur. Pieds circulaires en polyéthylène haute résistance, couleur noire.

Gestell aus Massivholz, Polsterung des Gestells der Sitzfläche aus PU-Schaum mit differenzierter, hoher Dichte, um Komfort, Weichheit und Langlebigkeit zu verbessern. Die Polsterung mit atmungsaktiver temperaturregulierter Faser sorgt zusammen mit dem elastischen weißen Stoff für eine große Weichheit. Runde Füße aus hochwiderstandsfähigem Polyethylen, schwarze Farbe.

C →
Cuscini / Cushions / Coussins / Kissen

I cuscini di schienale sono realizzati in piuma d'oca canalizzata (certificata Assopiuma) e fibra di poliestere.

Backrest cushions in channeled goose down (Assopiuma Gold Label certified) and polyester fibers.

Coussins de dossier en plume d'oie cloisonnée (certifiée Assopiuma, Label Or) et fibres de polyester.

PU-Schaum mit differenzierter, hoher Dichte (zertifiziert Assopiuma, "Goldenes Etikett") und Polyesternfasern.

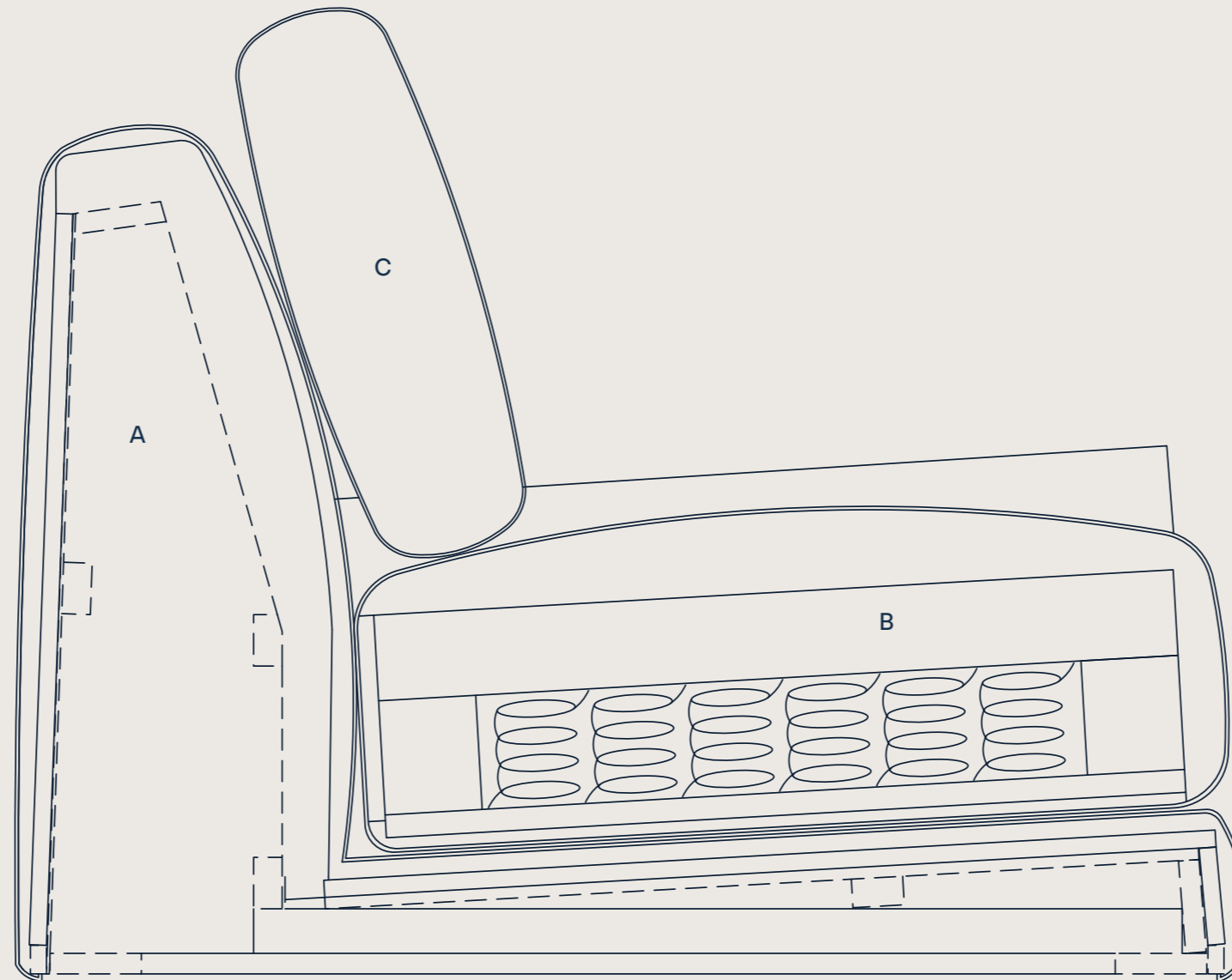

B →
Imbottitura / Upholstery /
Garnissage / Füllung

I cuscini di seduta sono realizzati in piuma d'oca canalizzata (certificata Assopiuma) con inserto centrale in poliuretano espanso a quote differenziate ad alta resilienza e molle insacchettate.

Seat cushions in channeled goose down (Assopiuma Gold Label certified) with core insert in high-resilience, variable-density polyurethane foam and independent pocket springs.

Coussins d'assise en plume d'oie cloisonnée (certifiée Assopiuma, Label Or) avec insert central en polyuréthane expansé à densité différenciée haute résilience et ressorts ensachés.

Sitzkissen mit gesteppter Gänsedaunenfüllung mit Kammern und Innenstegen (zertifiziert Assopiuma, "Goldenes Etikett"), mit Kern aus hochwiderstandsfähigem PU-Schaum mit differenzierter Dichte und Federung.

Sfoderabilità / Covers /
Déhoussage / Abziehbarkeit

I cuscini del sedile, dello schienale e la struttura sono completamente e facilmente sfoderabili a garanzia di una facile e frequente pulizia del rivestimento.

Structure, seat and backrest cushion covers are completely and easily removable in all versions, to guarantee easy and frequent cleaning of the covers.

Structure, coussins d'assise et de dossier entièrement et facilement déhoussables dans toutes les versions, permettant un lavage aisé et fréquent du tissu.

Gestell, Sitzkissen und Rückenkissen sind in allen Versionen komplett abziehbar, was eine einfache und häufige Reinigung der Bezüge garantiert.

La beauté de la simplicité et le confort prennent forme dans la nouvelle collection Loll dessinée par Paola Navone. Loll est une famille de canapés et de fauteuils accueillants et confortables, déhoussables. Loll exprime la notion de confort contemporain, accentué par le soin apporté aux détails, par la qualité des matériaux et par une fabrication artisanale. La silhouette des canapés est soulignée par le point de surjet qui, tel un tracé léger à la main, suit les contours principaux et les lignes douces de la collection. Loll se développe cette année avec un nouveau canapé modulaire, un projet dont le confort et la fonctionnalité sont exaltés ultérieurement, et permettent de générer des compositions toujours originelles. Grâce à ses modules avec de différentes formes et au dessin singulier des éléments angulaires, il est en fait possible de créer des configurations inédites et adaptables à chaque ambiance, domestique ou contract.

Loll bringt die Vorstellung von einem zeitgemäßen Komfort perfekt zum Ausdruck, der durch die Liebe zum Detail, die Qualität der Materialien und die unvergleichliche handwerkliche Verarbeitung eine ganz besondere Note erhält. Das Profil der Sofas wird durch die charakteristische Overlocknaht unterstrichen, die den essenziellen geometrischen Formen und weichen Linien der Kollektion wie ein leichter, freihändig gezeichneter Strich folgt. Diese Kollektion von Sofas und Sesseln wird dieses Jahr durch das neue modulare Sofa ergänzt, ein Projekt, bei dem Komfort und Funktionalität dank der Möglichkeit, immer neue Kompositionen zu kreieren, ihren maximalen Ausdruck finden. Die Elemente mit unterschiedlichen Formen und die besondere ECKELEMENTE ermöglichen immer neue Kombinationen, die bei jeder Einrichtung Platz finden und auch in Objektbereich eingesetzt werden können.

Loll racconta un'idea di comfort contemporaneo, reso speciale dalla cura dei dettagli, dalla qualità dei materiali e dall'unicità della lavorazione artigianale. Il caratteristico profilo taglia/cuci, come un tratto leggero disegnato a mano libera, segue le geometrie essenziali e le linee morbide delle forme. Collezione di divani e poltrone, Loll si amplia quest'anno con il nuovo divano modulare, un progetto in cui comodità e funzionalità trovano la loro massima espressione grazie alla possibilità di dare vita a composizioni sempre nuove. Grazie a moduli di forme diverse e al particolare disegno degli elementi angolari è infatti possibile creare configurazioni inedite e adattabili ad ogni tipo di ambiente domestico e contract.

Loll is a model that exudes contemporary comfort, rendered truly special by its attention to detail, high-quality materials and unique craftsmanship, such as the profile of the sofas accentuated by the characteristic overlock stitching which, like a delicate stroke drawn freehand, follows the collection's minimal geometry and soft lines. The Loll modular sofa completes the Loll family of sofas and armchairs, it is a project in which comfort and functionality are perfectly expressed through the creation of ever-new compositions. Thanks to modules with different shapes and to the particular design of the corner elements it is possible to create unusual compositions, suitable to any type of domestic and contract environment.

La beauté de la simplicité et le confort prennent forme dans la nouvelle collection Loll dessinée par Paola Navone. Loll est une famille de canapés et de fauteuils accueillants et confortables, déhoussables. Loll exprime la notion de confort contemporain, accentué par le soin apporté aux détails, par la qualité des matériaux et par une fabrication artisanale. La silhouette des canapés est soulignée par le point de surjet qui, tel un tracé léger à la main, suit les contours principaux et les lignes douces de la collection. Loll se développe cette année avec un nouveau canapé modulaire, un projet dont le confort et la fonctionnalité sont exaltés ultérieurement, et permettent de générer des compositions toujours originelles. Grâce à ses modules avec de différentes formes et au dessin singulier des éléments angulaires, il est en fait possible de créer des configurations inédites et adaptables à chaque ambiance, domestique ou contract.

Loll bringt die Vorstellung von einem zeitgemäßen Komfort perfekt zum Ausdruck, der durch die Liebe zum Detail, die Qualität der Materialien und die unvergleichliche handwerkliche Verarbeitung eine ganz besondere Note erhält. Das Profil der Sofas wird durch die charakteristische Overlocknaht unterstrichen, die den essenziellen geometrischen Formen und weichen Linien der Kollektion wie ein leichter, freihändig gezeichneter Strich folgt. Diese Kollektion von Sofas und Sesseln wird dieses Jahr durch das neue modulare Sofa ergänzt, ein Projekt, bei dem Komfort und Funktionalität dank der Möglichkeit, immer neue Kompositionen zu kreieren, ihren maximalen Ausdruck finden. Die Elemente mit unterschiedlichen Formen und die besondere ECKELEMENTE ermöglichen immer neue Kombinationen, die bei jeder Einrichtung Platz finden und auch in Objektbereich eingesetzt werden können.



Loll, Configuration 1

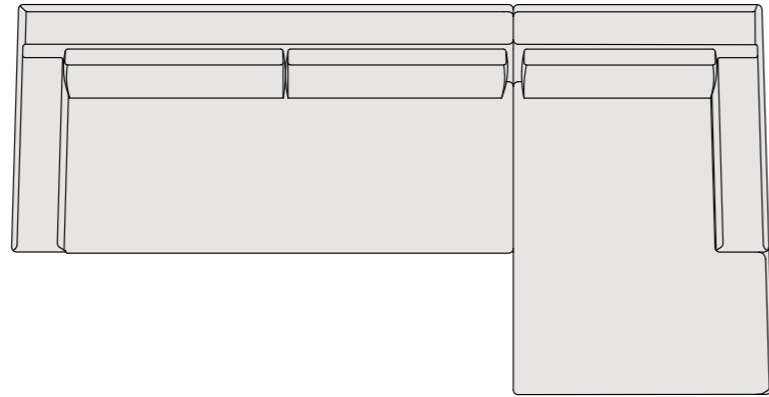

↑ 22 L + 20 R (details: p.31)

Sofa



Artist
Hopper

Cushions



Animals
Lion



Row Clay
Verso



Tweed
Sunset

Paprika Mood



Loll, Configuration 1



Configuration 1

*Divano / Sofa in Artist Hopper,
(overlock stitching Bordeaux);
Loose cushions:
1 C.Loll PI in Animals Lion
(Bordeaux);
2 C.Loll XS in Tweed Sunset
(Bordeaux), Row Clay Verso
(Bordeaux)*

Loll, Configuration 3





Loll, Configuration 3

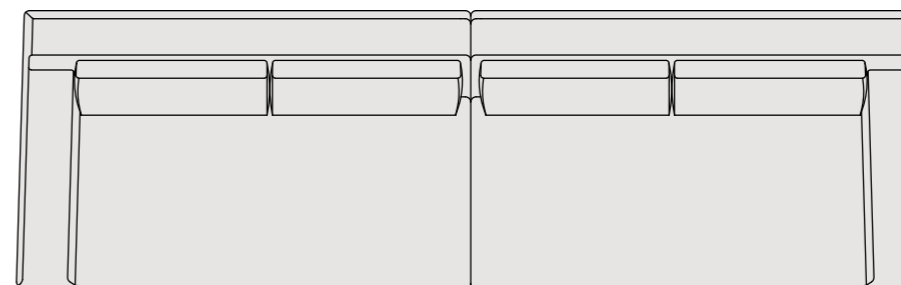

↑ 21 L + 21 R (details: p.31)

Sofa



Linum
Blush

Cushions



Animals
Lion



Linum
Mauve



Nuage
Saffron



Row Pearl
Verso



Winds
Scirocco

Blush Mood

Configuration 3

*Divano / Sofa in Linum Blush,
(overlock stitching Bordeaux);
Loose cushions:
3 C.Loll PI in Animals Lion
(Bordeaux), Linum Mauve (Rosa),
Row Pearl Verso (Rosa);
2 C.Loll XS in Nuage Saffron
(Bordeaux), Winds Scirocco
(Bordeaux)*

Loll, Configuration 6

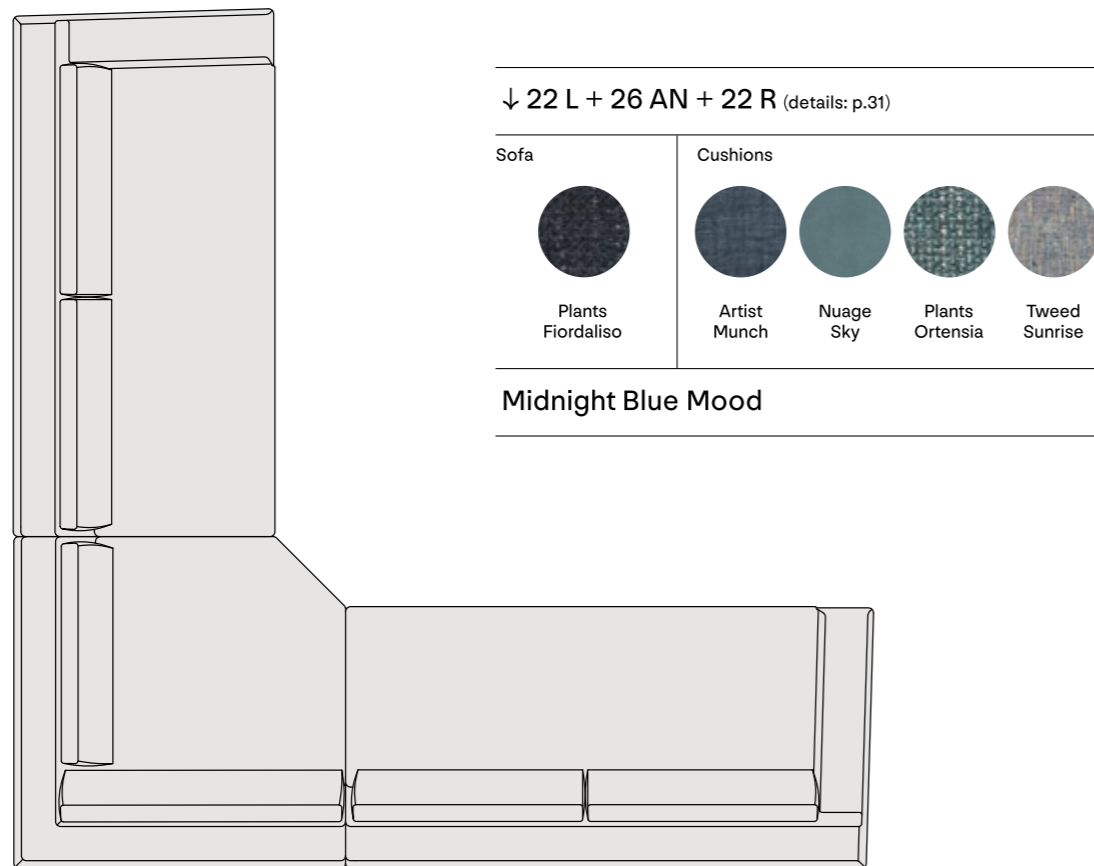

Loll, Configuration 6

Configuration 6

*Divano / Sofa in Plants Fiordaliso,
(overlock stitching Avio);
Loose cushions:
2 C. Loll PI in Plants Ortensia
(Spritz), Nuage Sky (Spritz);
2 C. Loll XS in Artist Munch (Avio),
Tweed Sunrise (Spritz)*



Loll, Configuration 8



Configuration 8

*Divano / Sofa in Linum Kaki,
(overlock stitching Tabacco);
Loose Cushions:
2 C. Loll PI in Linum Caramel
(Tabacco), Winds Bora (Scozia);
4 C. Loll XS in Artist Hopper
(Tabacco), Deus Bacco (Scozia),
Tweed Rye (Tabacco), Winds
Scirocco (Bordeaux)*



Loll, Configuration 8

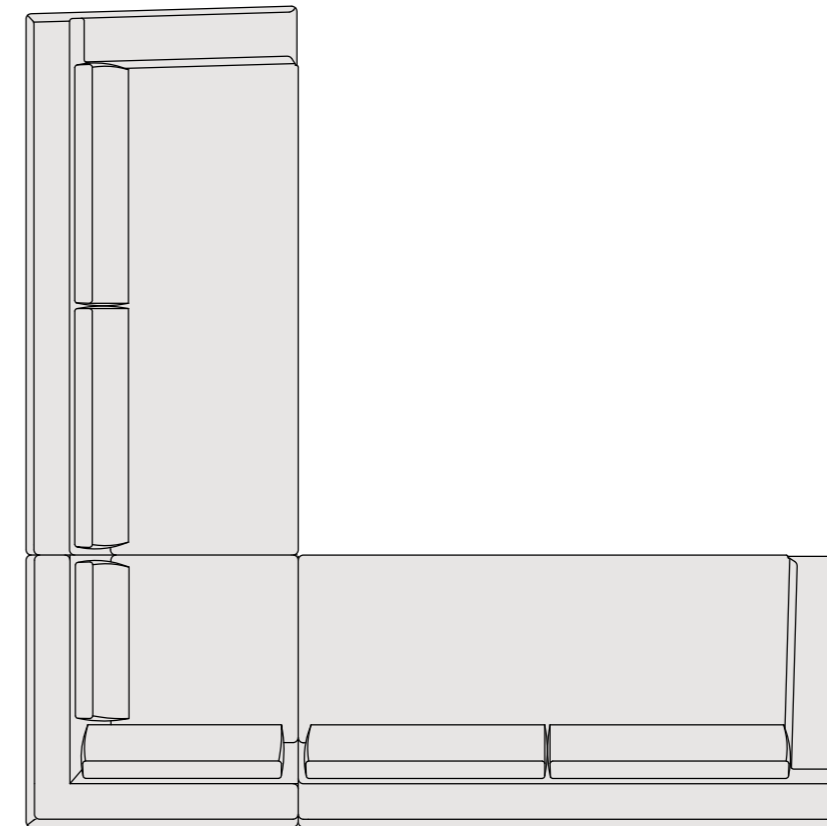

↑22 L + 27 AN + 22 R (details: p.32)

Sofa

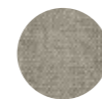

Linum Kaki

Cushions



Artist Hopper

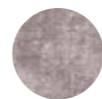

Deus Bacco



Linum Caramel



Tweed Rye



Winds Bora



Winds Scirocco

Sand Mood

Loll, Configuration 9/bis

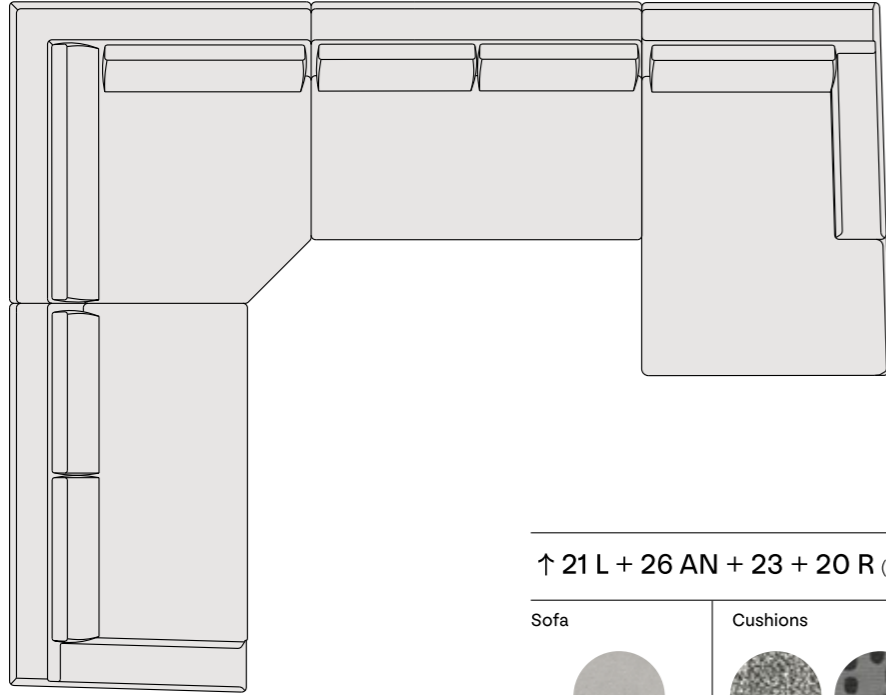

↑ 21 L + 26 AN + 23 + 20 R (details: p.32)

Sofa



Nuage
Fog

Cushions



Animals
Pigeon



Atmosfera
Uragano



Bear
Polar



Nuage
Iron



Row Ivory
Verso



Tweed
Rice

Papyrus Grey Mood



Loll, Configuration 9/bis

Configuration 9/bis

*Divano / Sofa in Nuage Fog,
(overlock stitching Ardesia);
Loose Cushions:
3 C. Loll PI in Atmosfera Urgano
(Ardesia), Row Ivory Verso (Ardesia),
Bear Polar;
3 C. Loll XS in Nuage Iron (Ardesia),
Animals Pigeon (Perla), Tweed Rice
(Perla)*



Loll, Configuration 10



Configuration 10

*Divano / Sofa in Tweed Barley, (overlock stitching Ardesia);
Loose Cushions:
2 C. Loll PI in Artist Cezanne (Verde), Nuage Sun (Ardesia);
4 C. Loll XS in Winds Ostro (Ardesia), Winds Bora (Verde),
Linum Concrete (Verde), Tweed Rye (Tabacco)*

Loll, Configuration 10

↓22 L + 25 AN + 22 R (details: p.32)

Sofa



Tweed Barley

Cushions

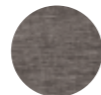

Artist Cezanne



Linum Concrete



Nuage Sun



Tweed Rye



Winds Bora



Winds Ostro

Stone Grey Mood

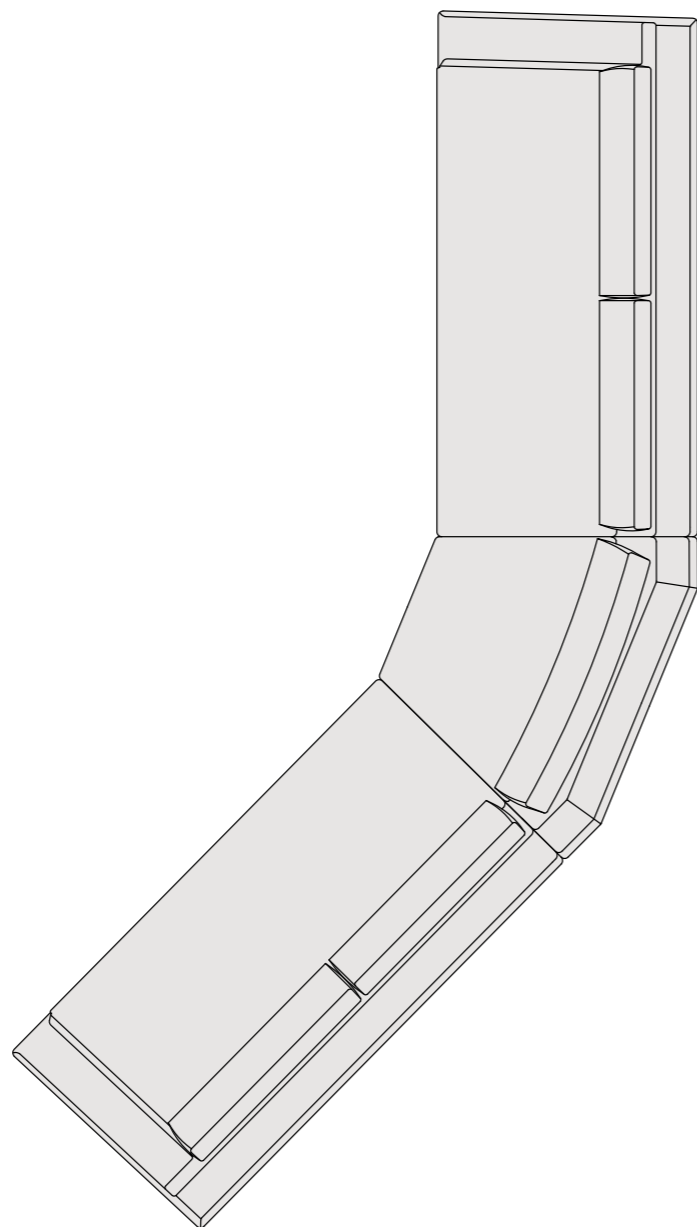

Loll, Configuration 11

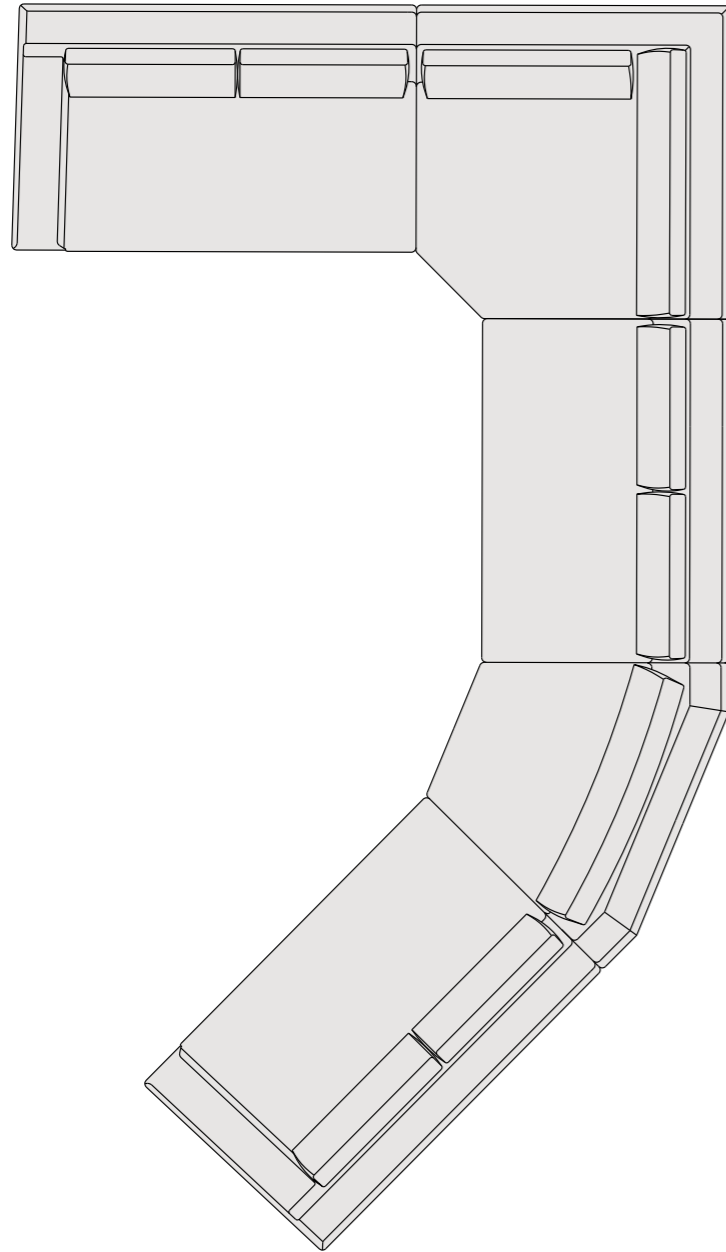

↑ 21 L + 26 AN + 23 + 25 AN + 21 R (details: p.32)

Sofa



Deus Tritone

Cushions



Artist Rembrandt



Artist Renoir



Deus Bacco



Row Midnight Verso

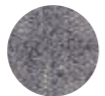

Row Seal Verso

Dusty Blue Mood



Loll, Configuration 11



Configuration 11

*Divano / Sofa in Deus Tritone,
(overlock stitching Mare);
Loose Cushions:
2 C. Loll PI in Deus Bacco (Mare),
ROW Seal Verso (Mare);
3 C. Loll XS in Row Midnight
Verso (Mare), Artist Renoir (Rosa),
Artist Rembrandt (Rosa)*

Loll, Modular details

Elemento componibile, struttura in legno massello rivestita in poliuretano espanso a quote differenziate, localizzate, ad alta densità. Cuscini di seduta in piuma d'oca canalizzata con inserto centrale in poliuretano espanso a quote differenziate ad alta resilienza e molle insacchettate. Cuscini di schienale imbottiti in piuma d'oca canalizzata e fibre di poliestere. Rivestimenti sfoderabili.

Modular element, frame in solid wood upholstered with variable-density polyurethane foam. Seat cushions in channeled goose down, with core insert in high-resilience, variable-density polyurethane foam and independent pocket springs. Backrest cushions in channeled goose down and polyester fibers. Removable covers.

Anbau-Element, Gestell aus Massivholz mit Beschichtung aus unterschiedlich dichtem und lokalisiertem PU-Schaum mit hoher Dichte. Sitzkissen aus kannelierten Gänsedaunen mit Kern aus unterschiedlich dichtem und hochwiderstandsfähigem PU-Schaum mit hoher Widerstandsfähigkeit und Federung. Rückenkissen mit gesteppter Gänsedaunenfüllung mit Kammern und Innenstegen und Polyesterfasern. Abziehbare Bezüge.

Élément pour composition, structure en bois massif recouverte de polyuréthane expansé à densité différenciée et de haute densité. Coussins d'assise en plume d'oie cloisonnée avec insert central en polyuréthane expansé à densité différenciée haute résilience et ressorts ensachés. Coussins de dossier en plume d'oie cloisonnée et fibres de polyester. Tissus déhoussables.

Elemento laterale / End element
Élément terminaison / Endelement

Loll 20 L-R

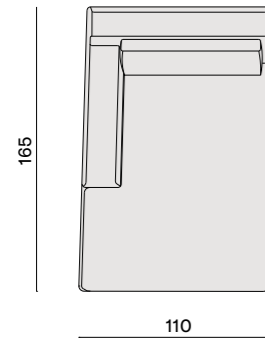

Loll 21 L-R

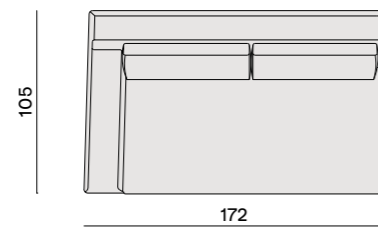

Loll 22 L-R

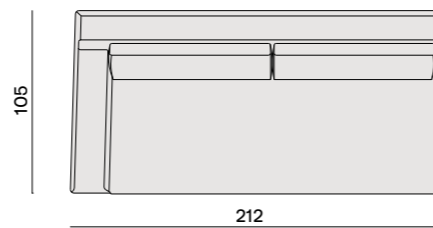

Elemento angolare / Corner element
Element d'angle / Eckelement

Loll 25 AN

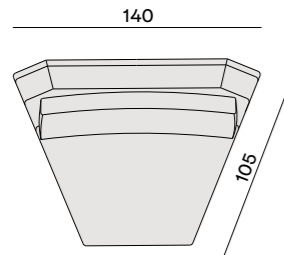

Loll 26 AN

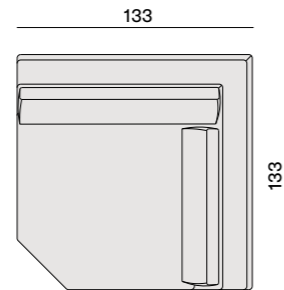

Loll 27 AN

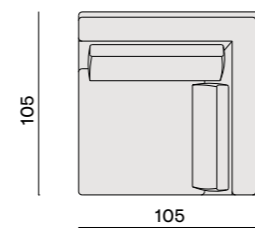

Elemento centrale / Central element
Élément central / Mittelelement

Loll 23

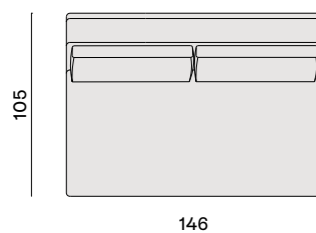

Cuscini / Cushions
Coussins / Kissen

C. Loll GR

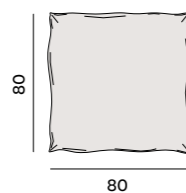

C. Loll PI

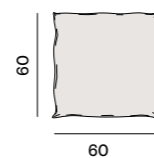

C. Loll XS

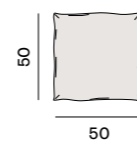

Loll, Configurations details

Configuration 1 — p.02

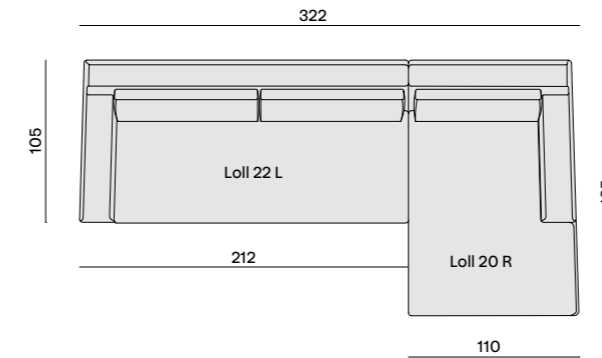

Configuration 2

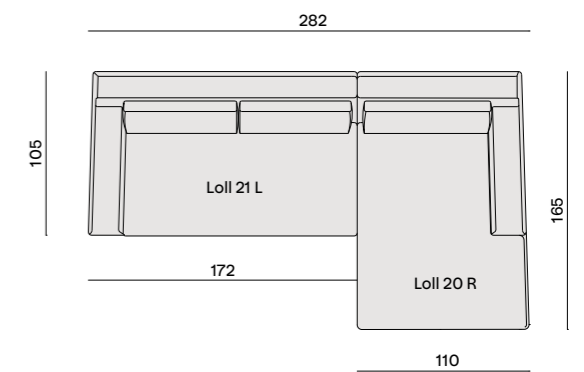

Configuration 3 — p.06

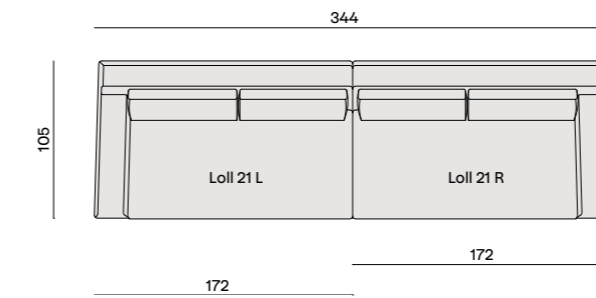

Configuration 4

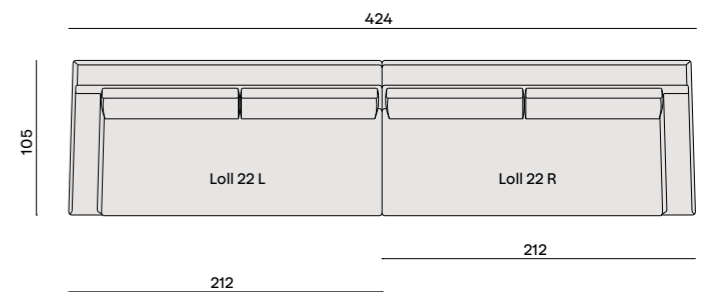

Configuration 5

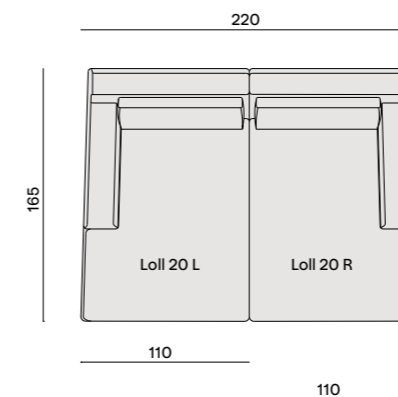

Configuration 6 — p.10

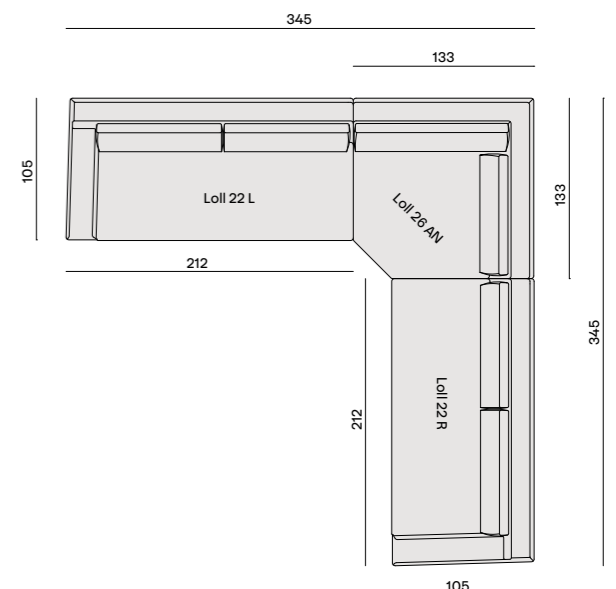

Configuration 7

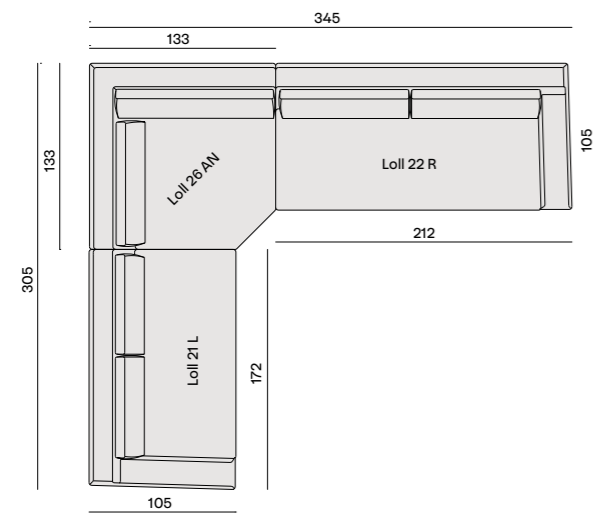

Configuration 8 — p.14

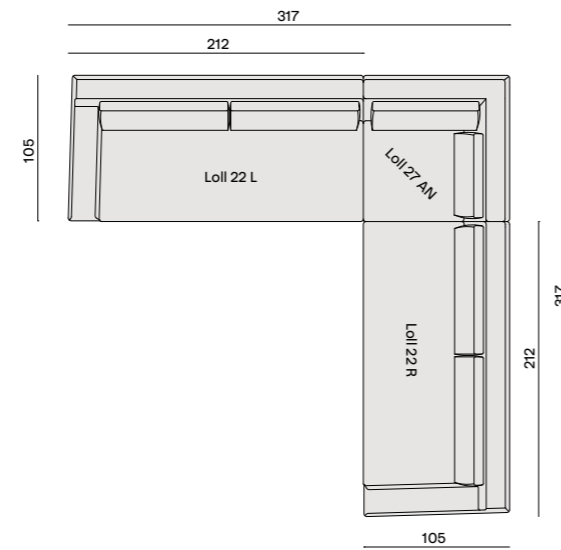

Configuration 9

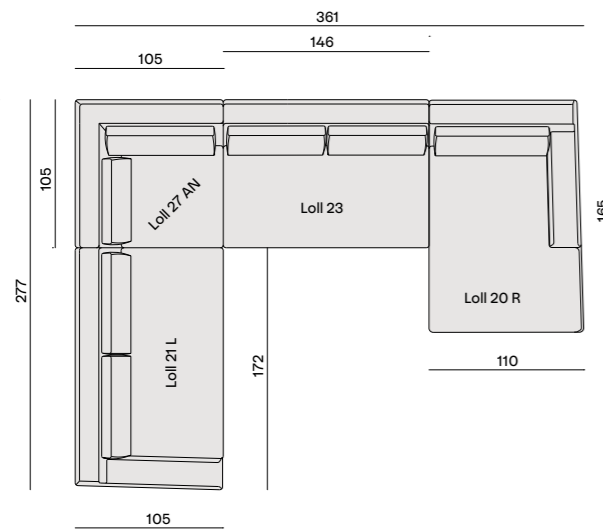

Configuration 9/bis — p.18

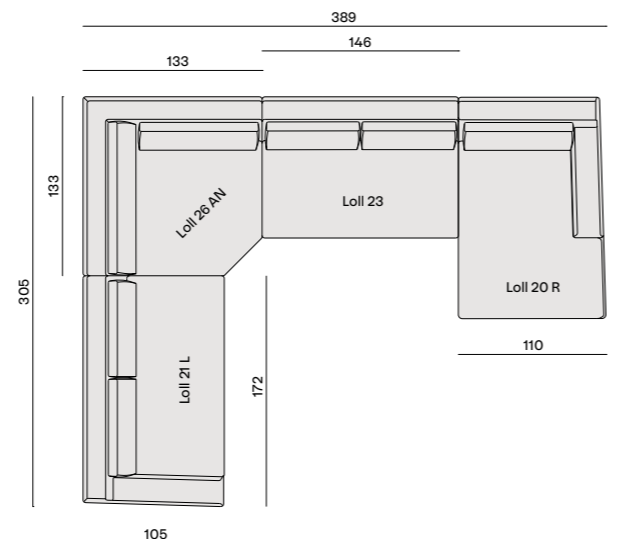

Configuration 10 — p.22

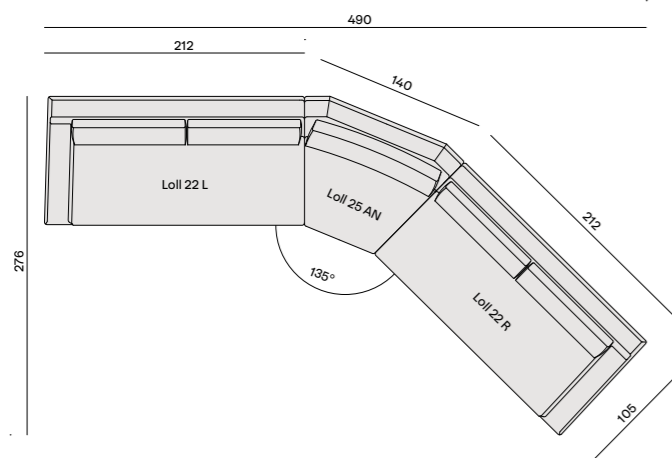

Configuration 11 — p.26

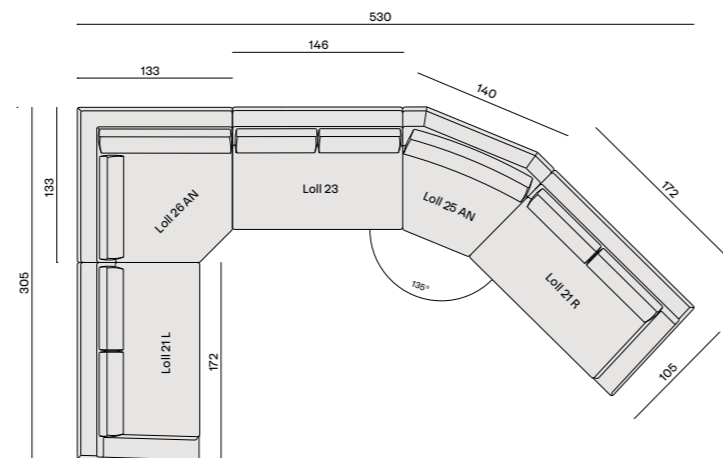

Gervasoni Spa

Viale del Lavoro, 88
 33050 Pavia di Udine
 (UD) Italia
 tel. +39 0432 656 611
 fax +39 0432 656 612
 info@gervasoni1882.com

gervasoni1882.com

Gervasoni Spa

*Viale del Lavoro, 88
33050 Pavia di Udine
(UD) Italia
tel. +39 0432 656 611
fax +39 0432 656 612
info@gervasoni1882.com*

