

LEM S80 | Height-adjustable stool

Shin & Tomoko Azumi | 2000



LEM

Shin & Tomoko Azumi | 2000

In 1969, man landed on the moon in the LEM (Lunar Excursion Module). In 2000, at the turn of the millennium, the LEM stool was created and became one of the symbols of Lapalma's style. The same lightness, the same absence of gravity, which, in the void created by the design, fosters its relationship with the environment. And like the Apollo 11, as it could not bear unnecessary weights, this amazing chair incorporated all functions in a highly elegant minimalist profile. Only the essential, the rest stayed on the ground.



LEM

Shin & Tomoko Azumi | 2000



S80 | Height-adjustable stool Stool H66÷79 mat chromed gas lift

Stool with swivel seat and adjustable height with metal frame mat chromed and base covered by a stainless steel sheet Aisi304 "linen fabric" pattern or entirely powder coated. Mat chromed piston. Seat in plywood in several finishes. Felt under the base.

TEST DIN 68 877/81 5.6



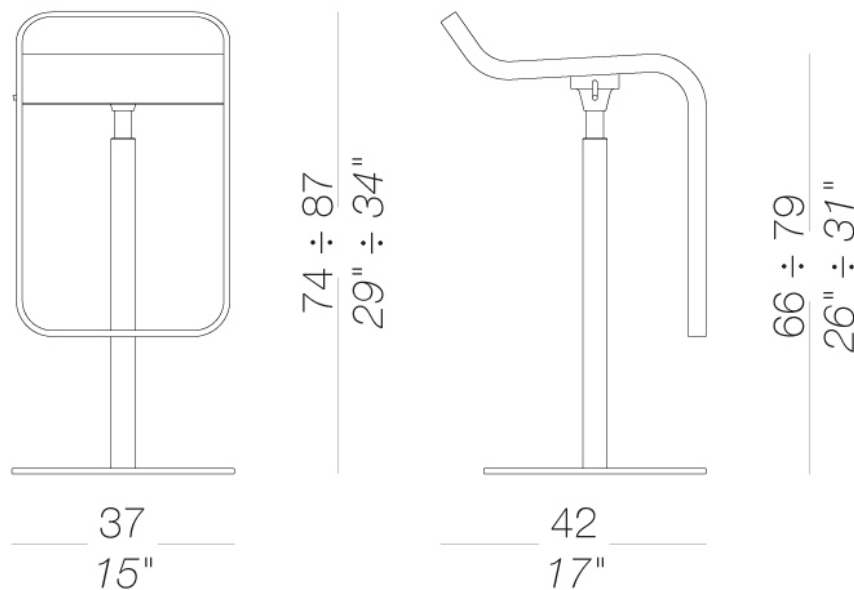





TEST 1 IM - Valencia

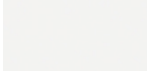











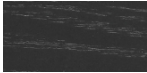



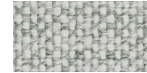











LEM S80 | Height-adjustable stool

Shin & Tomoko Azumi | 2000

frame

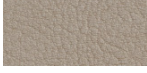
							
powder coating black 1 Colors	powder coating white 1 Colors	powder coating perla 1 Colors	powder coating celeste 1 Colors	powder coating mattone 1 Colors	powder coating caffè 1 Colors	powder coating oliva 1 Colors	powder coating tortora 1 Colors
							
metal mat chromed 1 Colors							

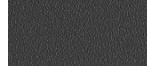
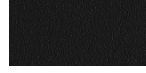
seat

							
wood blanch oak 1 Colors	wood black open pore 1 Colors	wood oak dark walnut 1 Colors	lacquered lacquered 8 Colors	laminate fenix 9/10 2 Colors	metal stainless steel 1 Colors	fabric Hallingdal 65 - Grade C 58 Colors	fabric Canvas 2 - Grade C 45 Colors
							
fabric Steelcut Trio 3 - Grade D 54 Colors	fabric Remix 3 - Grade C 72 Colors	fabric Clara 2 - Grade C 24 Colors	fabric Fiord 2 - Grade C 39 Colors	fabric Divina MD - Grade D 27 Colors	fabric Divina Melange 3 - Grade D 38 Colors	fabric Tonica 2 - Grade C 39 Colors	fabric Medley - Grade A 37 Colors
							
fabric Maya - Grade A 43 Colors	fabric Jet - Grade A 66 Colors	fabric Lapalma Smart - Grade C 18 Colors	fabric Capture - Grade B 43 Colors	fabric Crisp - Grade B 40 Colors	fabric Nattè - Grade B 30 Colors	fabric Iris - Grade B 24 Colors	fabric Steelcut 3 - Grade D 40 Colors
							
ecoleather GRIMM FR - Grade A 32 Colors	ecoleather Valencia - Grade B 66 Colors	leather leather 7 Colors	plastics grey polyurethane 1 Colors	plastics black polyurethane 1 Colors	fabric Grain - Grade. B 50 Colors	fabric Re-wool - Grade C 21 Colors	

consult the portfolio for the range of colors, fabrics, eco-leather, soft-leather.

use and maintenance instructions

Clean all parts in wood, leather, fabric and metal with a damp cloth or a diluted neutral cleaner. Do not use cleaners with alcohol, bleach, solvent or abrasive products. Any liquid spilt on the product must be wiped up immediately. When lifting or moving the product, hold it on the structure and not under the seat. The product should not be subjected to unbalanced weights, as it is designed for a proper rest on the foothold (on four legs or on the base). Our company relieves from any responsibility in case of damage caused to fragile floors. Avoid any improper use of the product: do not step on the product, on the footrest or on the armrests. Avoid any movements that could compromise the proper functionality of the product or the safety of the users. Wood and leather, being natural materials, could be easily damaged. Small impurities or imperfections are within quality standard range. Do not expose the product to weather conditions or atmospheric agents, nor to heat sources over 40°C. Also products for outdoor use could be afflicted by atmospheric agents. The product could undergo possible exterior changes due to particular exposure to heat, humidity and saltiness. An appropriate and frequent maintenance and cleaning of the product enhances its durability. The product could change colour and shade, if exposed to direct sunlight. Maintenance has to be carried out by experienced staff. Dispose of the package only after assembling the product, in order to avoid the loss of ironmongery and components. Once the product has been dismantled, the product itself or its components must be given to the public garbage disposal system, according to the legislation in force.