

m o o o i[®]



Jackson Chair

by Marcel Wanders

A grand backrest of embroidered and black leather to recline on and swivel whilst sitting comfortably.

Designer	Marcel Wanders
Year of design	2016
Material	Steel, HR foam, Leather
Additional	Jackson Footstool can be ordered separately.

dimensions

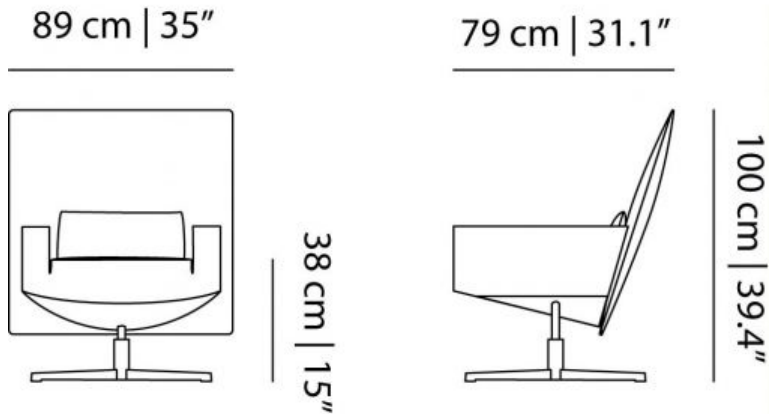

Jackson chair & footstool packaging

Jackson Chair

H 100 | 39.4"

W 89 | 35"

D 107 | 32.1"

Jackson Footstool

H 40 | 15.7"

W 58 | 22.8"

D 58 | 22.8"

Signature leather

thickness

1.0 – 1.2 mm

origin

European rawhide, typically from Italy, Germany, Austria, Switzerland and Scandinavia

surface

matt, soft with subtle visible texture

finish

light surface protection

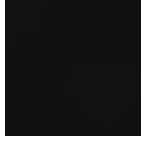

Bouclé

composition

43% co, 28% pan, 14% pa, 12% vi, 3% pl

abrasion

20.000> martindale

lightfastness 4

firetest

EN1021 I&2

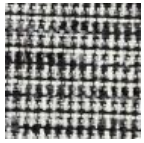

Bouclé
Black white

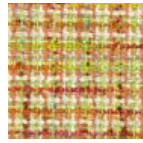

Bouclé
Rainbow



Bouclé
Brown

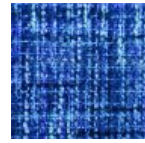

Bouclé
Blue

Abbracci

composition

100% pl

abrasion

50.000 martindale

lightfastness 4

firetest

FR BS5852 0/1

EN1021 I&2



Abbracci
Black

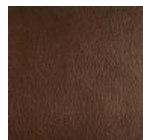

Abbracci
Brown



Abbracci
Grey

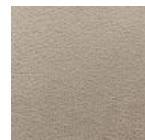

Abbracci
Oyster

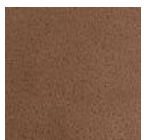

Abbracci
Taupe

Jacquard andaz

composition:

34% cotton - 30% viscose - 24% linen - 12% polyamide

abrasion:

25000 martindale

firetest:

BS EN 1021 1&2



Jacquard
Andaz

Jacquard Fresco

composition

40% vi ,36% co,14% pl, 10% li

abrasion

20.000> martindale

firetest

EN1021 1&2



Jacquard
Fresco

Jacquard Old Black & Blue

composition

52% vi, 38% co, 10% li

abrasion

20.000> martindale

firetest

EN1021 1&2



Jacquard
Old Blue

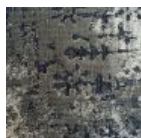

Jacquard
Old Black

Divina 3

Composition

100% new wool

Martindale

45.000

Pilling

3

Lightfastness

7

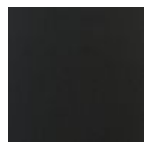

Divina 3
Black



Divina 3
Blue

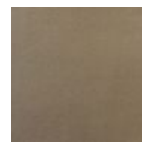

Divina 3
Brown

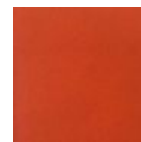

Divina 3
Orange

Divina Melange 2

Composition

100% New wool

Durability

45.000 Martindale

Pilling

3

Lightfastness

6-7

Sustainability

Natural fibres / Sustainable resource



Divina Melange
120



Divina Melange
170



Divina Melange
180

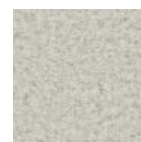

Divina Melange
220

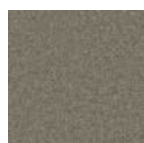

Divina Melange
260

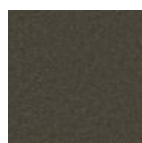

Divina Melange
280

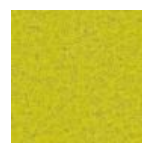

Divina Melange
421

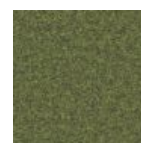

Divina Melange
471



Divina Melange
521

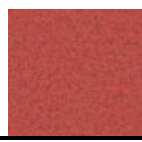













Divina Melange
531



Divina Melange
571



Divina Melange
581

	Divina Melange 620		Divina Melange 631		Divina Melange 671		Divina Melange 681
	Divina Melange 721		Divina Melange 731		Divina Melange 771		Divina Melange 821
	Divina Melange 871		Divina Melange 920		Divina Melange 931		Divina Melange 971

Macchedil, Grezzo

composition

47% co, 20% vi, 18% pi, 8% li, 5% pc, 2% af

abrasion

18.000 martindale

lightfastness 4

firetest

EN1021 I&2

	Macchedil Grezzo Black indigo		Macchedil Grezzo Pinkish		Macchedil Grezzo Offwhite		Macchedil Grezzo Light grey
	Macchedil Grezzo Light brown		Macchedil Grezzo Grey grey		Macchedil Grezzo Anthracite		Macchedil Grezzo Blue grey
	Macchedil Grezzo Cappuchino		Macchedil Grezzo Deepblue				

Macchedil, Sottile

m o o o i[®]

composition

49% vi, 24% pl, 21% li, 6% co

abrasion

30.000 martindale

lightfastness 4

firetest

EN1021 I&2

	Macchedil Sottile Black indigo		Macchedil Sottile Pinkish		Macchedil Sottile Off white		Macchedil Sottile Light grey
	Macchedil Sottile Light brown		Macchedil Sottile Grey grey		Macchedil Sottile Anthracite		Macchedil Sottile Blue grey
	Macchedil Sottile Cappucino		Macchedil Sottile Deep blue				

Oray

composition

8% co, 38% vi, 15% pl, 39% li

abrasion

30.000 martindale

lightfastness 4

	Oray Cream		Oray Sand		Oray Rock		Oray Mineral
	Oray Gravel		Oray Dark Gull		Oray Copper		Oray Rust
	Oray Flamboyant		Oray Oil		Oray Aqua		Oray Peyote

m o o i[®]



Oray
Ocean



Oray
Metal



Oray
Griffin



Oray
Dusk



Oray
Chestnut



Oray
Dark



Oray
Indigo



Oray
Ochre