

Minotti

HAMILTON DESIGN RODOLFO DORDONI

Hamilton è un programma di sedute dal design lineare, composto da divani fissi ed aggregabili fra loro, che permettono una progettualità oltre che originale, estremamente completa. Hamilton è proposto in tre tipologie: Hamilton, Hamilton "Sofa" e Hamilton "Modulo".

Struttura: in legno massello.

Preparazione della struttura: poliuretano espanso a quote differenziate e ad alta resilienza. Prima foderatura in fibra termolegata con tela di cotone bianca.

Cinghie: cinghie elastiche ad alto componente di caucciù e ad elasticità controllata.

Cuscineria: imbottitura cuscini seduta e schienale in piuma d'oca canalizzata con inserto in poliuretano ad alta resilienza.

Base prima versione: realizzata con telaio in metallo a sezione ovale 40x20 mm con finitura black-nickel lucida; appoggio a terra tramite piedini tecnici neri arretrati.

Base seconda versione: appoggio a terra tramite piedini in frassino poro aperto tinto moka, senza base perimetrale.

Sfoderabilità: il rivestimento è completamente sfoderabile nella versione in tessuto smontando la base perimetrale, mentre è fisso nella versione in pelle.

Optional: cuscino Hamilton 40x40 cm e 60x60 cm, cuscino Cross 40x40 cm e 60x60 cm, cuscino Milano 46x46 cm, con imbottitura 100% in piuma d'oca canalizzata. Completamente sfoderabili.

Hamilton is a seating system with a simple design, composed of fixed sofas which allow an original and fully project design. Hamilton is available in 3 versions: Hamilton, Hamilton "Sofa" and Hamilton "Modulo".

Frame: in solid wood.

Frame preparation: high resilience polyurethane foam of various densities. First lining made from fibre thermally bound to white cotton cloth.

Straps: woven elastic straps with a high rubber content and controlled elasticity.

Cushions: seat and back cushions padded with goose down divided into sections with high resilience polyurethane inset.

First version base: in metal frame oval section 40x20 mm, finishing in glossy black-nickel with black back feet.

Second version base: with feet in open pore moka finish, without perimeter base.

Covers: fully removable in the fabric version by taking the external supporting base apart, non-removable in the leather version.

Optional: Hamilton cushion 40x40 cm and 60x60 cm, Cross cushion 40x40 cm and 60x60 cm, Milano cushion 46x46 cm, entirely padded with goose down divided into sections. Fully removable.



Das Sitzprogramm Hamilton zeichnet sich durch geradliniges Design aus. Es besteht aus fixen und kombinierbaren Elementen die unterschiedlichste Kompositionen ermöglichen. Das Sofasystem ist in 3 Typologien unterteilt: Hamilton, Hamilton "Sofa" und Hamilton "Modulo".

Rahmen: aus Massivholz.

Herstellung des Rahmens: aus hoch widerstandsfähigem Polyurethanschaum in unterschiedlicher Dichte. Erster Bezug ist aus wärmegebundener, auf weißem Baumwollgewebe aufkaschierter Faser.

Riemen: elastische Riemen mit hohem Kautschukanteil und kontrollierter Elastizität.

Kissen: Kissenpolsterung der Sitzfläche und Rücklehne aus kanalisierten Gänsedaunen mit hochwiderstandsfähigem Polyurethankern.

Gestell Version 1: Basis realisiert aus Metall mit ovalem Querschnitt 40x20 mm in der Ausführung Black-Nickel glänzend. Das Sofa steht durch zurückgesetzte schwarze Füße auf dem Boden auf.

Gestell Version 2: das Sofa steht durch sichtbare Füße aus Eschenholz offenporig, mokkafarben lackiert, auf dem Boden auf. Keine umlaufende Basis.

Abnehmbare Bezüge: der Stoffbezug lässt sich komplett abnehmen, während der Lederbezug fix ist. Zum Abziehen muss die umlaufende Basis abmontiert werden.

Optional: Kissen Hamilton 40x40 cm und 60x60 cm, Kissen Cross 40x40 cm und 60x60 cm, Kissen Milano 46x46 cm, mit Füllung aus 100% Gänsedaunen. Vollständig abziehbar.

Hamilton est un système d'assises du design linéaire composé par éléments-canapés fixes et associables entre eux qui permettent de réaliser des projets très originaux mais extrêmement complets. Hamilton est proposé en trois différentes typologies: Hamilton, Hamilton "Sofa" et Hamilton "Modulo".

Structure: en bois massif.

Préparation de la structure: polyuréthane expansé à hauteurs différenciées et à haute résilience. Première doublure en fibre thermolée avec une toile en coton blanc.

Sangles: sangles élastiques tressées à haute teneur en caoutchouc et à élasticité contrôlée.

Coussins: rembourrage des coussins d'assise et dossier en plumes d'oie à secteurs avec élément central en polyuréthane à haute résilience.

Base première version: en métal à section ovale 40x20 mm avec finition black-nickel brillante et pieds techniques arrières couleur noir.

Base deuxième version: avec pieds en frêne pore ouvert teinté moka, sans base.

Possibilité d'enlever la housse: revêtement en tissu entièrement déhoussable en démontant les bases en métal, mais fixe dans la version en cuir.

Optionnel: coussin Hamilton 40x40 cm et 60x60 cm, coussin Cross 40x40 cm et 60x60 cm, coussin Milano 46x46 cm, avec rembourrage 100% duvet d'oie à secteurs. Entièrement déhoussable.

Minotti

HAMILTON

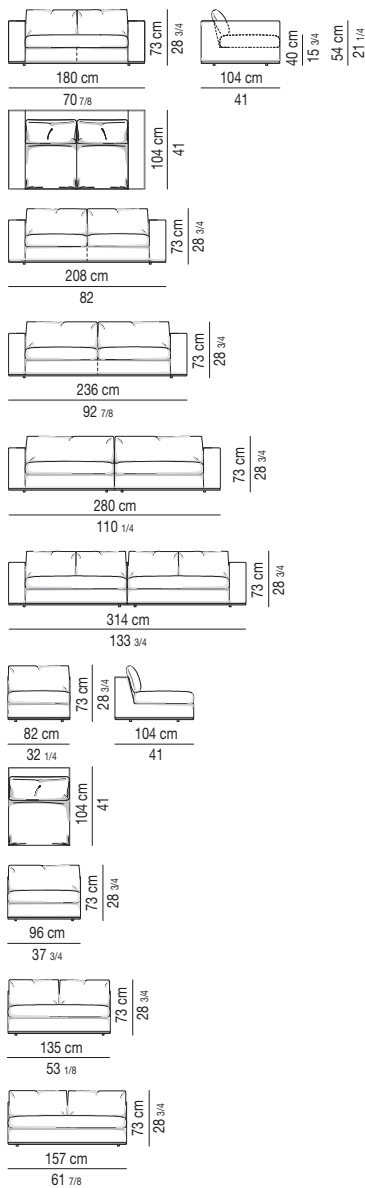

HAMILTON "MODULO"

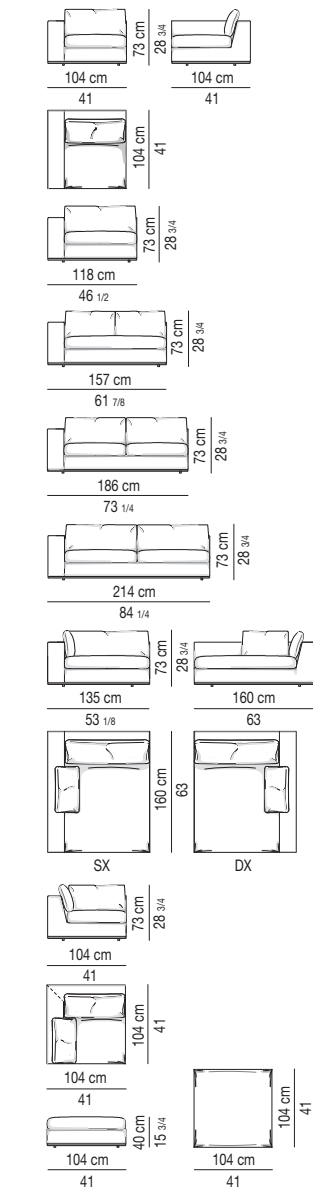
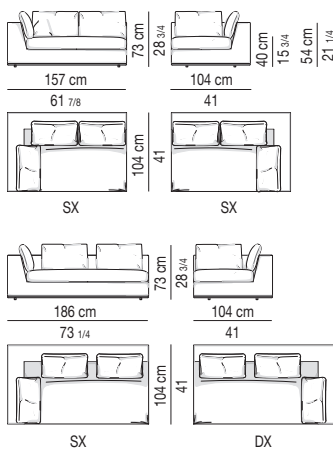

CUSCINI / CUSHIONS "HAMILTON"

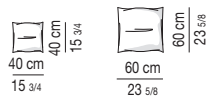

CUSCINI / CUSHIONS "CROSS"

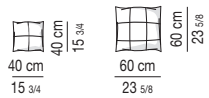

CUSCINO / CUSHION "MILANO"

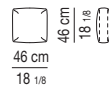

POGGIATESTA / HEADREST

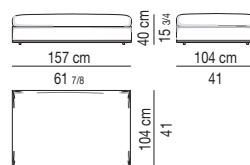
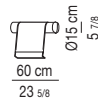

CUSCINO SCHIENALE / BACK CUSHION '05

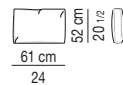

POGGIATESTA / HEADREST



Minotti

HAMILTON "SOFA"

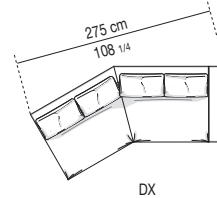
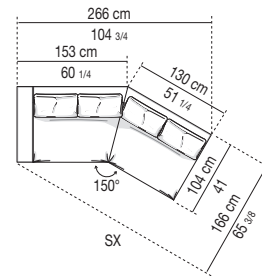
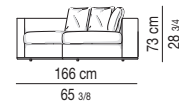
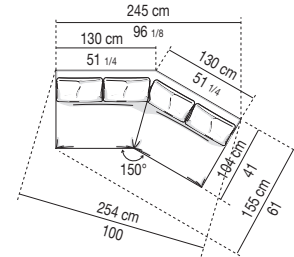
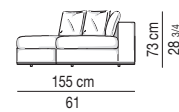
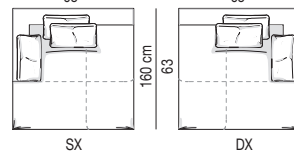
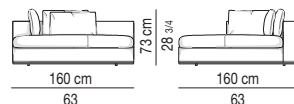
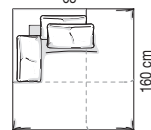
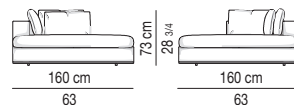
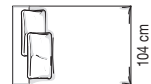
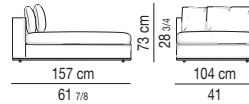
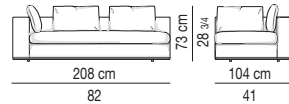
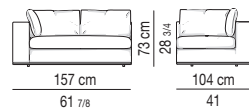
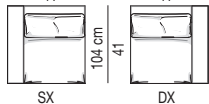
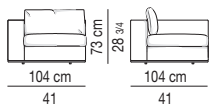
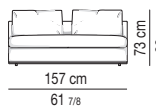
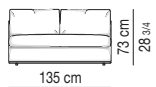
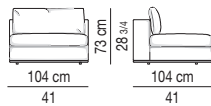
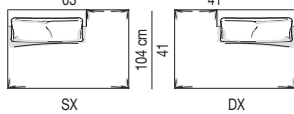
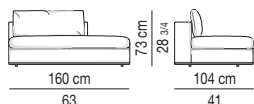
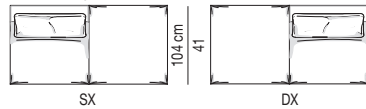
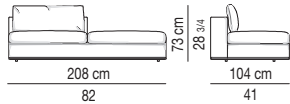
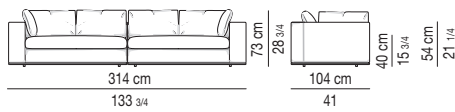

TAVOLINO / COFFEE TABLE "LEGER-HAMILTON"

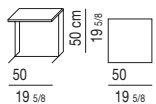

N.B.: il tavolino nella versione H 50 cm si inserisce all'altezza della seduta del divano.
ATTENTION: the coffee table H 50 cm reaches the sofa's seat height.

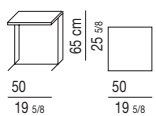

N.B.: il tavolino nella versione H 65 cm si inserisce sopra il bracciolo.
ATTENTION: the coffee table H 65 cm goes over the armrest.

TAVOLINO / COFFEE TABLE "FLORENCE-HAMILTON"

