

HIDDENWIDE.R-NST6

Hidden Channel Datasheet



Product codes

Unit:	Type:	Compatible Strip Light:	Length:	Colour:	Version:
HIDDENWIDE	R (RECESSED)	NST6 (NST6.IP-LN)	2.0m	W (White)	1.0

Dimensions (mm)

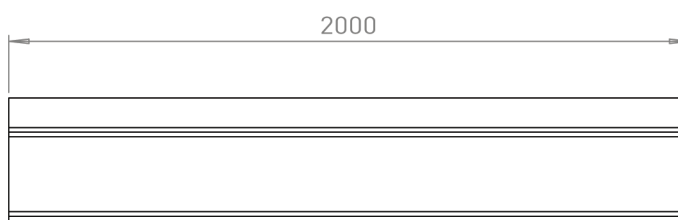
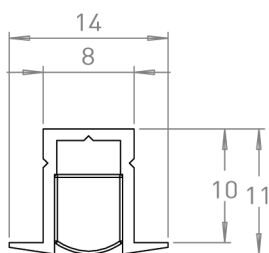

Installation - Recessed

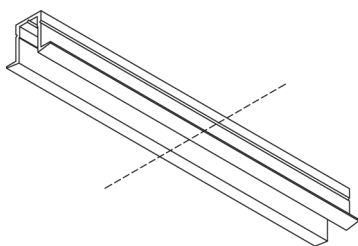

Step 1

Cut the Channel down to size.

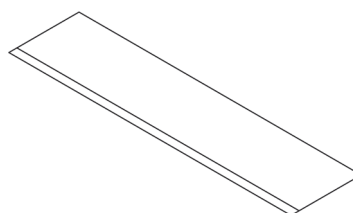

Step 2

Using a 8mm Router Bit, cut a 8mm wide slot and 10mm deep slot into 10mm plaster board or 10mm into joinery.

Installation - Recessed

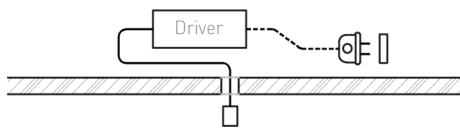

Step 3

Remote mount and connect the driver to the mains power cable in line with the Australian Standards. Ensure the low voltage cable is routed through the hole cut.

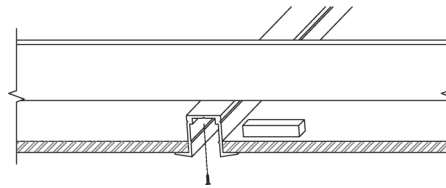

Step 4

Insert the Channel into the slot and fix it to the joists using the screw provided.

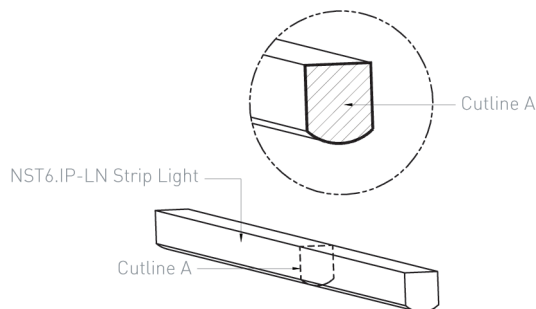

Step 5

Cut the strip light to length that matches the channel length.

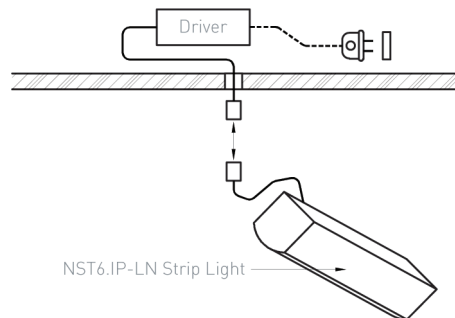

Step 6

Wire the NST6.IP-LN Striplight into the driver (sold separately) using the wire crimps.

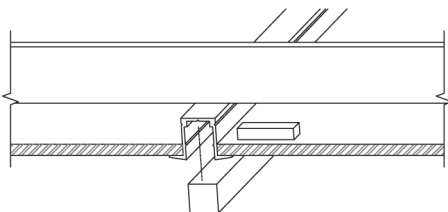

Step 7

Snap the NST6.IP-LN Striplight into the channel.

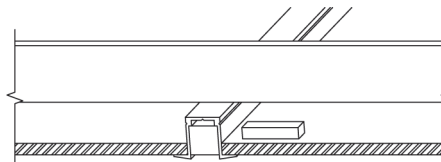

Step 8

Installation Complete.