

HIDDENWASH.S-NST10

Hidden Channel Datasheet



Product codes

Unit:	Type:	Compatible Strip Light:	Length:	Colour:	Version:
HIDDENWASH	S (SURFACE)	NST10 (NST10.IP-LN)	2.0m	W (White)	1.0

Dimensions (mm)

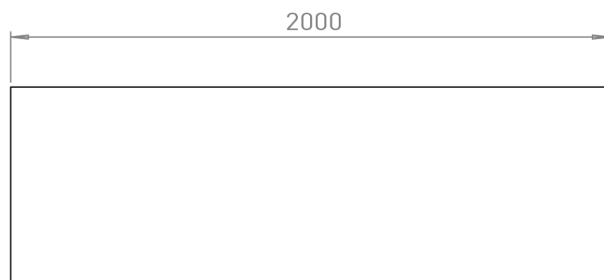
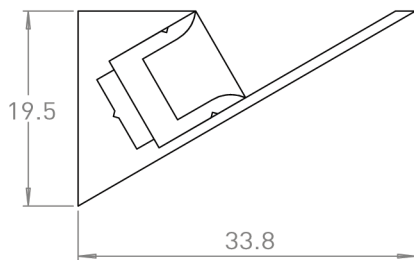

Installation - Surface

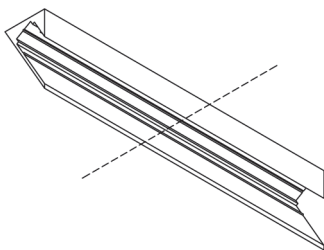

Step 1

Cut the Channel down to size.

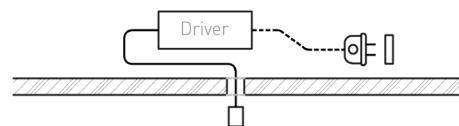

Step 2

Remote mount and connect the driver to the mains power cable in line with the Australian Standards. Ensure the low voltage cable is routed through the hole cut.

Installation - Surface

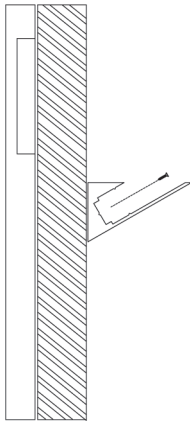

Step 3

Attach the hidden channel with the provided screws.

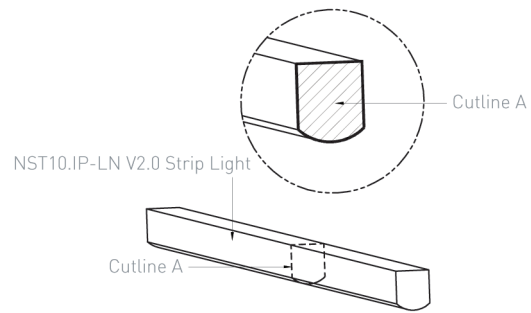

Step 4

Cut the strip light to length that matches the channel length.

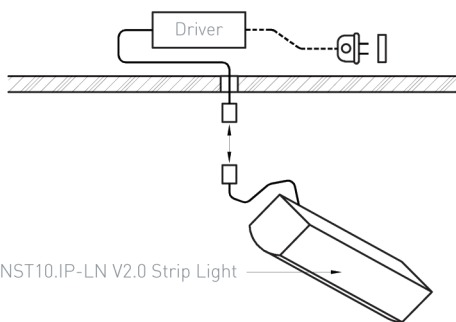

Step 5

Wire the NST10.IP-LN V2.0 Striplight into the driver (sold separately) using the wire crimps.

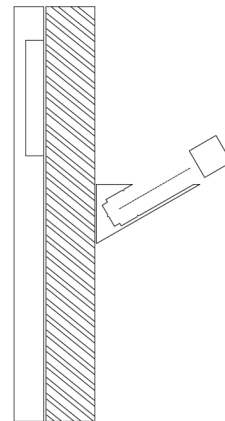

Step 6

Snap the NST10.IP-LN V2.0 Striplight into the channel.

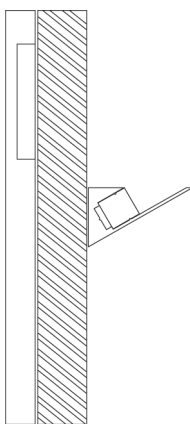

Step 7

Installation Complete.