

HIDDENWASH.RS-NST10

Hidden Channel Datasheet



Product codes

Unit:	Type:	Compatible Strip Light:	Length:	Colour:	Version:
HIDDENWASH	RS (RECESSED/SURFACE)	NST10 (NST10.IP-LN)	2.0m	W (White)	1.0

Dimensions (mm)

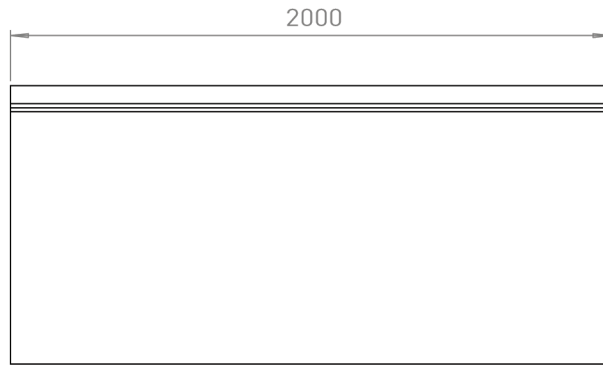
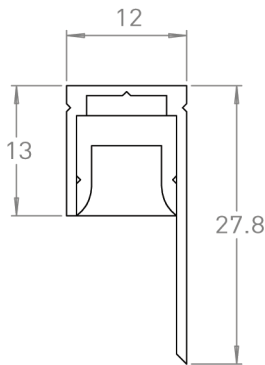

Installation - Recessed

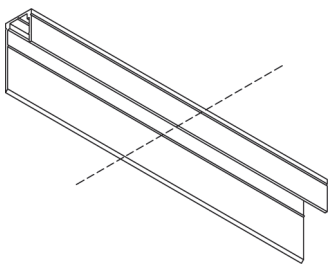

Step 1

Cut the Channel down to size.

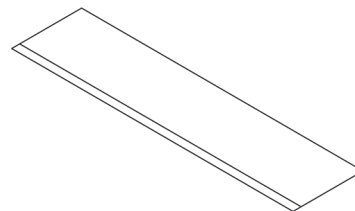

Step 2

Using a 12mm Router Bit, cut a 12mm wide slot and 13mm deep slot into 13mm plaster board or 13mm into joinery.

Installation - Recessed

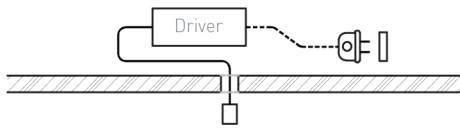

Step 3

Remote mount and connect the driver to the mains power cable in line with the Australian Standards. Ensure the low voltage cable is routed through the hole cut.

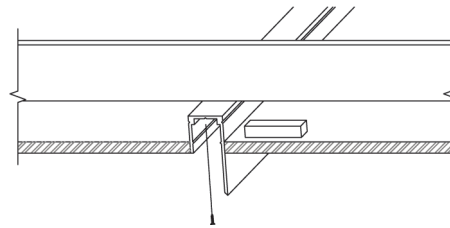

Step 4

Insert the Channel into the slot and fix it to the joists using the screw provided.

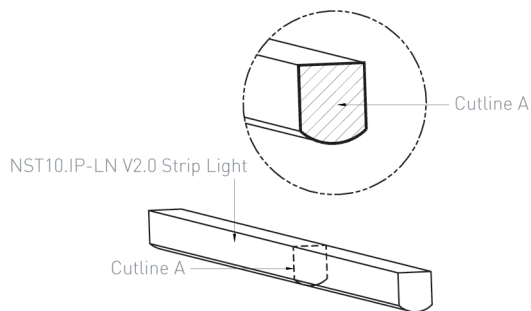

Step 5

Cut the strip light to length that matches the channel length.

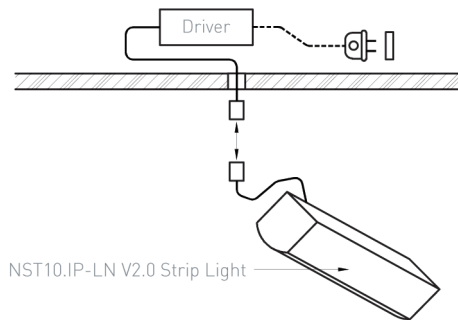

Step 6

Wire the NST10.IP-LN V2.0 Striplight into the driver (sold separately) using the wire crimps.

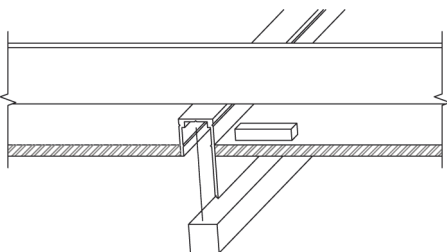

Step 7

Snap the NST10.IP-LN V2.0 Striplight into the channel.

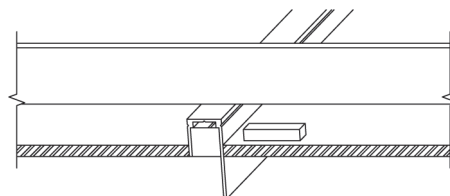

Step 8

Installation Complete.

Installation - Surface

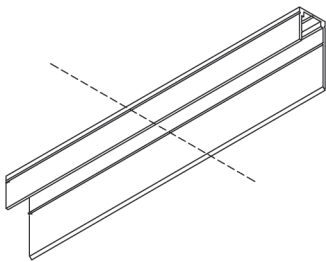

Step 1

Cut the Channel down to size.

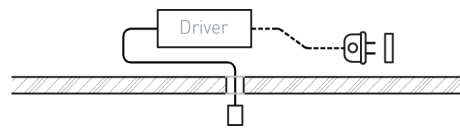

Step 2

Remote mount and connect the driver to the mains power cable in line with the Australian Standards. Ensure the low voltage cable is routed through the hole cut.

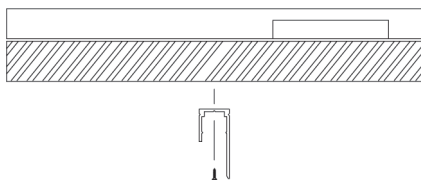

Step 3

Attach the hidden channel with the provided screws.

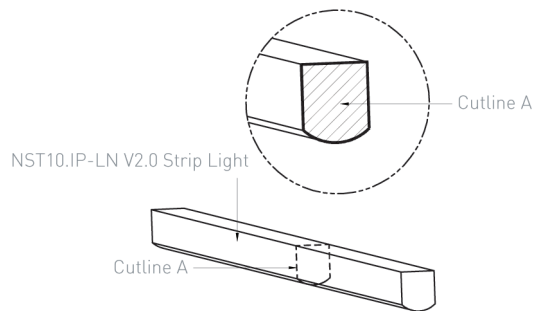

Step 4

Cut the strip light to length that matches the channel length.

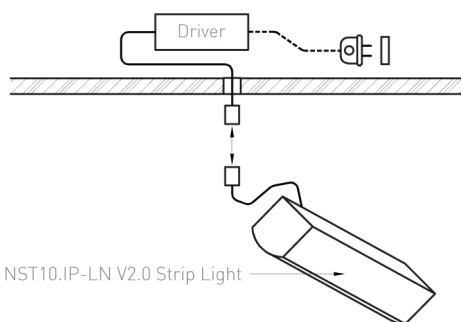

Step 5

Wire the NST10.IP-LN V2.0 Striplight into the driver (sold separately) using the wire crimps.

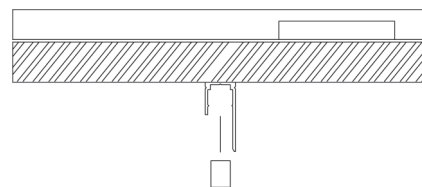

Step 6

Snap the NST10.IP-LN V2.0 Striplight into the channel.

Installation - Surface

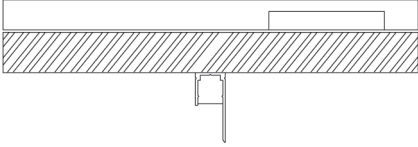

Step 7

Installation Complete.