

# HIDDENWASH.R-NST6

## Hidden Channel Datasheet



### Product codes

Unit:	Type:	Compatible Strip Light:	Length:	Colour:	Version:
HIDDENWASH	R (RECESSED)	NST6 (NST6.IP-LN)	2.0m	W (White)	1.0

### Dimensions (mm)

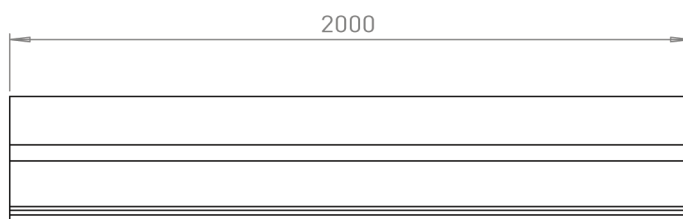
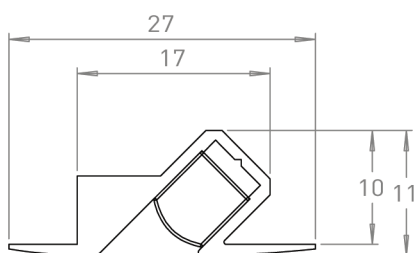

### Installation - Recessed

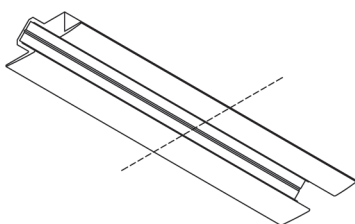

#### Step 1

Cut the Channel down to size.

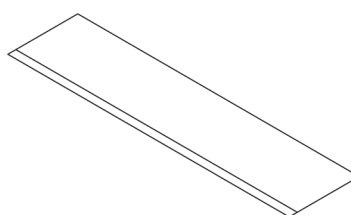

#### Step 2

Using a 17mm Router Bit, cut a 17mm wide slot and 10mm deep slot into 10mm plaster board or 10mm into joinery.

## Installation - Recessed

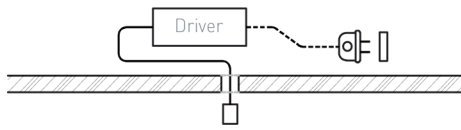

### Step 3

Remote mount and connect the driver to the mains power cable in line with the Australian Standards. Ensure the low voltage cable is routed through the hole cut.

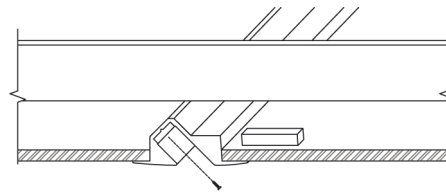

### Step 4

Insert the Channel into the slot and fix it to the joists using the screw provided.

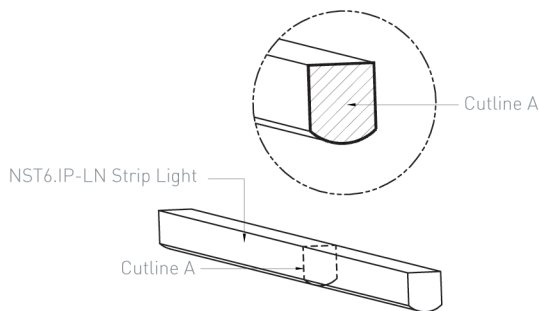
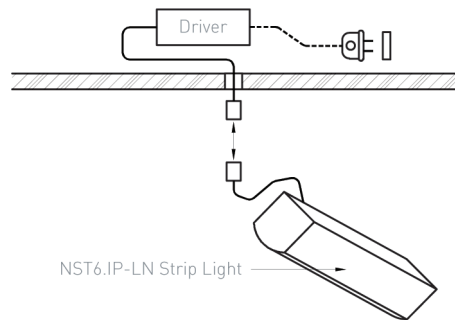

### Step 5

Cut the strip light to length that matches the channel length.

### Step 6

Wire the NST6.IP-LN Striplight into the driver (sold separately) using the wire crimps.

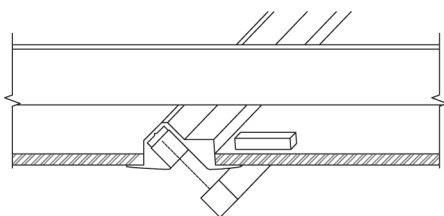

### Step 7

Snap the NST6.IP-LN Striplight into the channel.

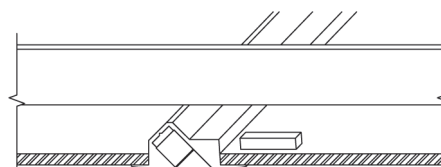

### Step 8

Installation Complete.