

FREEMAN SEATING SYSTEM

DESIGN RODOLFO DORDONI



UN SISTEMA DI SEDUTE DALLA DUPLICE PERSONALITÀ | A SEATING SYSTEM WITH A DUAL PERSONALITY

Freeman racchiude in se' una doppia identità: gli elementi Freeman "Duvet" sono caratterizzati da linee morbide ed avvolgenti e da una cuscineria extra-soft, pensata per offrire un'esperienza di calda accoglienza e grande relax.

Gli elementi Freeman "Tailor" presentano una personalità differente, con i loro volumi più definiti e le sedute monoblocco disegnate da impunture che ne accentuano il carattere grafico e l'esprit contemporaneo.

L'unione delle due anime consente di realizzare composizioni dal carattere dinamico, che scandiscono momenti diversi della giornata e modi differenti di utilizzare il divano.

Freeman embodies this dual identity: the Freeman "Duvet" elements feature smooth, enveloping lines and extra-soft cushions that, like a warm embrace, induce a feeling of pure relaxation.

The Freeman "Tailor" elements express a different personality, with their more defined shapes and one-piece seats enhanced with top-stitching that accents their graphic nature and contemporary spirit.

The wedding of these two spirits makes it possible to create compositions, with a dynamic air that characterize different moments in the day and different ways of using the sofa.

Freeman besitzt eine doppelte Identität: Die Elemente Freeman "Duvet" zeichnen sich durch ihre geschmeidigen, kuscheligen Linien und die Kissen extra-soft aus, erdacht, um das Erlebnis eines warmen Empfangs und der vollkommenen Entspannung zu vermitteln.

Die Elemente Freeman "Tailor" besitzen eine diverse Persönlichkeit, mit stärker definierten Volumen und kompakten Sitzen, charakterisiert durch Steppnähte, die den graphischen Aspekt und den zeitgenössischen Esprit unterstreichen. Das Zusammenspiel beider Elemente erlaubt die Realisierung von Kompositionen mit dynamischem Charakter für die verschiedenen Momente unseres Tages und die verschiedenen Rollen des Sofas in unserem Leben.

Freeman renferme une double identité : les éléments Freeman "Duvet" se démarquent par des lignes souples et enveloppantes et par des coussins extra-soft, conçus pour offrir l'expérience d'un accueil chaleureux et d'une grande détente.

Les éléments Freeman "Tailor" affichent une personnalité différente, avec leurs volumes plus définis et les assises monobloc dessinées par des matelassages qui en accentuent le caractère graphique et l'esprit contemporain.

L'union des deux âmes permet de réaliser des compositions au caractère dynamique, qui rythment les différents moments de la journée et les différentes manières d'utiliser le canapé.

ELEMENTI "DUVET" | "DUVET" ELEMENTS

CARATTERIZZATI DA STRUTTURA - SCHIENALI E BRACCIOLI - DISEGNATI DA IMPUNTURE E CUSCINI SEDILE EXTRA-SOFT
 CHARACTERIZED BY STRUCTURE - BACKRESTS AND ARMRESTS - DISPLAYNG DETAILED STITCHING AND EXTRA-SOFT SEAT CUSHIONS

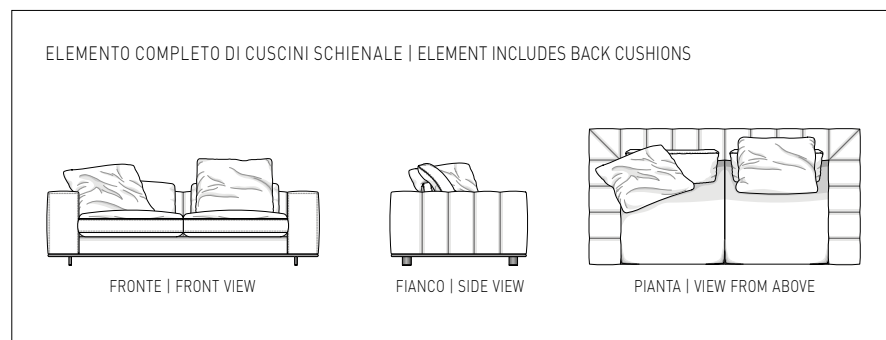

Seduta

Cuscini di seduta extra-soft, con inserto centrale in poliuretano, avvolto da imbottitura in memory foam e da uno strato di morbida piuma.

Cuciture

Schienale e braccioli sono caratterizzati da un particolare sistema di cuciture: le varie parti di tessuto sono assemblate tra loro con una fettuccia in ecopelle e doppie cuciture.

Seat cushions

Extra-soft seat cushions with polyurethane core insert, wrapped in memory foam padding and topped with a layer of soft down.

Stitching

Backrest, seats and armrests feature a unique stitching detail - the various parts of the fabric are joined by a strip of eco-leather finished with a double-stitched motif.

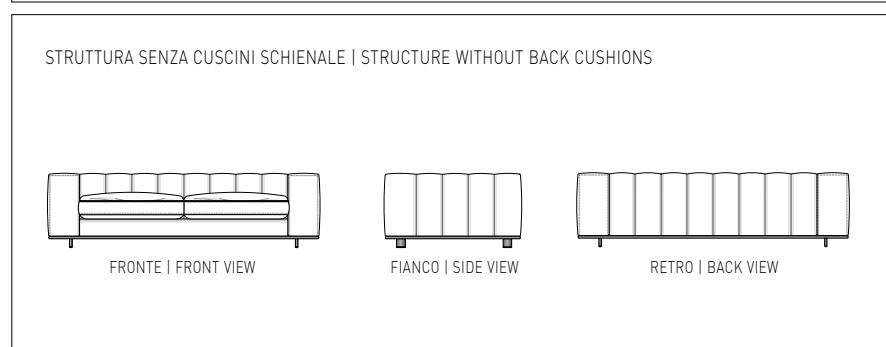

ELEMENTI "TAILOR" | "TAILOR" ELEMENTS

CARATTERIZZATI DA SEDUTE SENZA CUSCINO SEDILE E STRUTTURA COMPLETAMENTE DISEGNATA DA IMPUNTURE
 CHARACTERIZED BY ONE-PIECE SEAT, BACKRESTS AND ARMRESTS, ALL DISPLAYNG DETAILED STITCHING

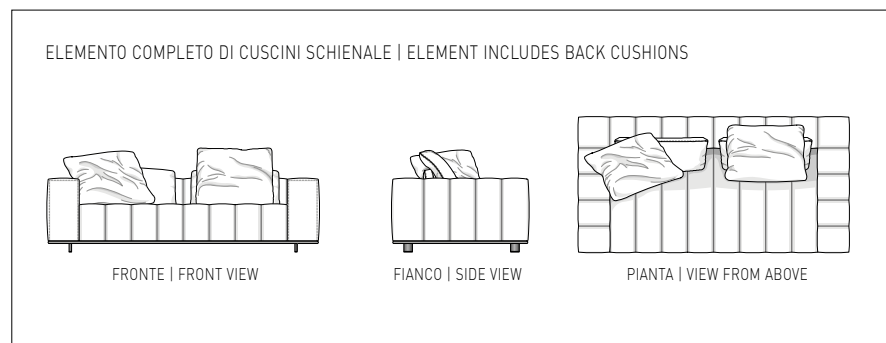

Seduta

Sedute monoblocco caratterizzate da originale sistema di cuciture.

Cuciture

Schienale, sedute e braccioli sono caratterizzati da un particolare sistema di cuciture: le varie parti di tessuto sono assemblate tra loro con una fettuccia in ecopelle e doppie cuciture.

Seat cushions

One-piece seat features original decorative stitching.

Stitching

Backrest, seats and armrests feature a unique stitching detail - the various parts of the fabric are joined by a strip of eco-leather finished with a double-stitched motif.

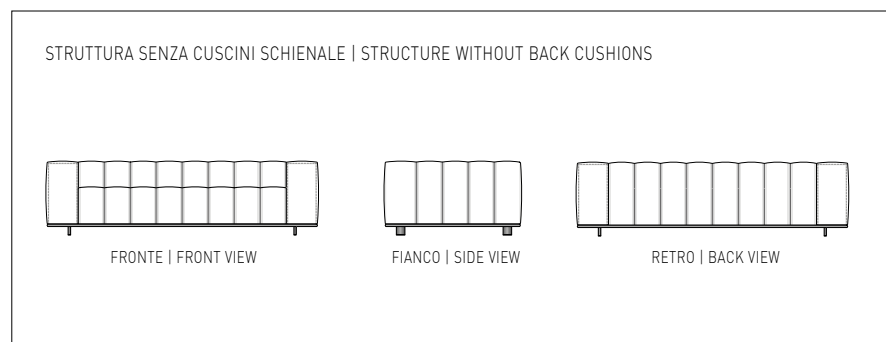

ELEMENTI "TAILOR WING" E "TAILOR MIX" | "TAILOR WING" AND "TAILOR MIX" ELEMENTS

Gli elementi Freeman "Tailor" presentano un'interessante variante con schienale e bracciolo "Wing", ambedue caratterizzati da una linea asciutta e leggera, grazie ad una struttura in metallo schiumata in poliuretano, in netta contrapposizione con il volume importante delle sedute. L'utilizzo degli schienali o dei braccioli "Wing" contribuisce ad alleggerire visivamente le composizioni realizzate con gli elementi "Tailor", rendendole più dinamiche.

The Freeman "Tailor" elements provide a charming alternative with "Wing" backrests and armrests, both featuring clean, light lines thanks to a polyurethane foam-covered structure, in clear contrast to the considerable volume of the seats. The use of "Wing" backrests and armrests adds visual lightness to the compositions created with the "Tailor" elements, making them more dynamic.

Die Elemente Freeman "Tailor" bieten eine interessante Variante, mit "Wing" an Rücken- und Armstütze, beide charakterisiert durch die einfache, leicht erscheinende Linie, dank der mit Polyurethanschaum überzogenen Metallstruktur, in klarem Gegensatz zu dem flauschigen Volumen der Sitze. Die Rücken- und Armstützen mit "Wing" tragen dazu bei, die Kompositionen mit den Elementen "Tailor" optisch leichter erscheinen zu lassen und sie dynamischer zu gestalten.

Les éléments Freeman "Tailor" présentent une variante intéressante avec dossier et accoudoir "Wing", caractérisés tous les deux par une ligne sobre et légère, grâce à une structure en métal et polyuréthane moulé, contrastant nettement avec le volume important des assises. L'utilisation des dossiers ou des accoudoirs "Wing" contribue à alléger visuellement les compositions réalisées avec les éléments "Tailor", tout en les rendant plus dynamiques.

ELEMENTI "TAILOR WING" | "TAILOR WING" ELEMENTS

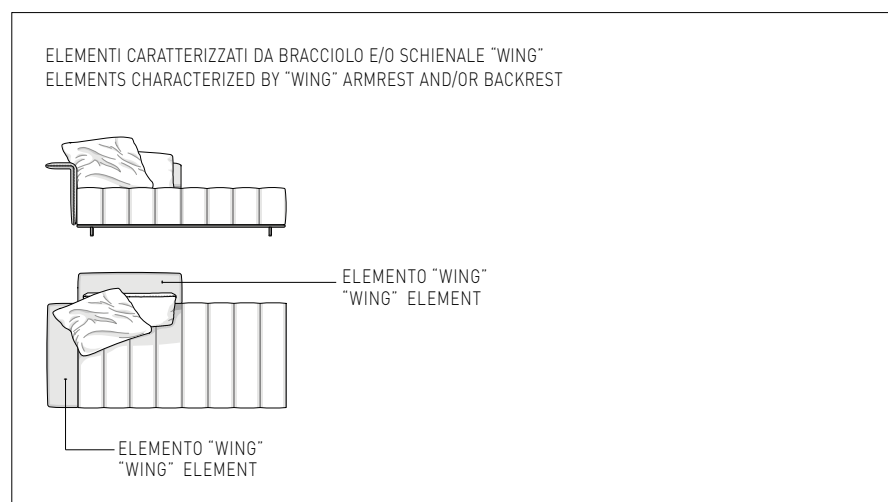

ELEMENTI "TAILOR MIX" | "TAILOR MIX" ELEMENTS

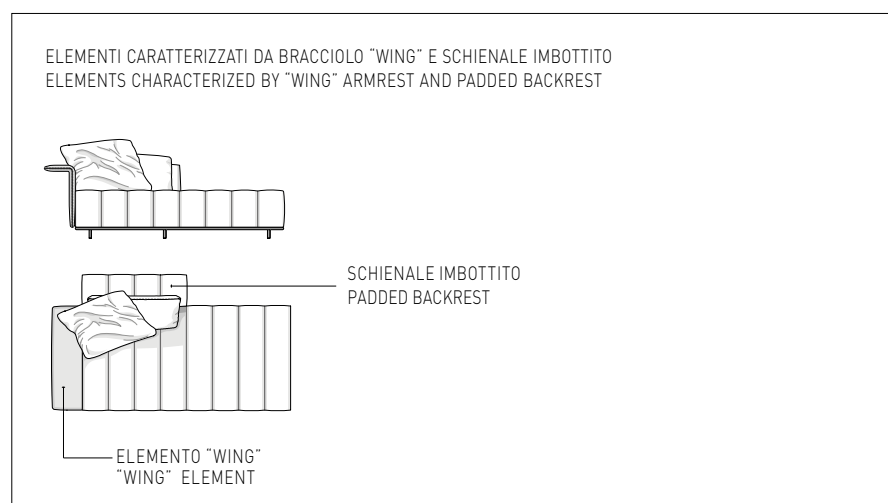



ESEMPI DI UTILIZZO BRACCIOLI E SCHIENALI "WING" | HOW TO USE "WING" ARMRESTS AND BACKRESTS

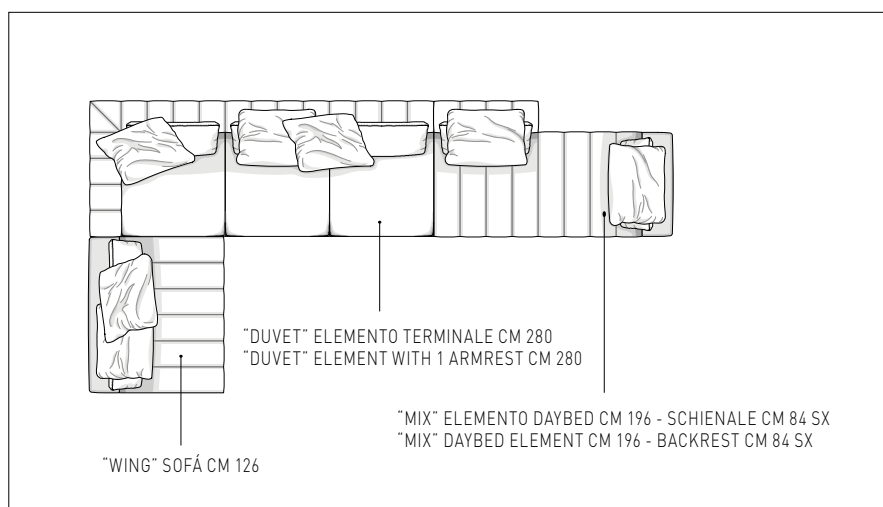
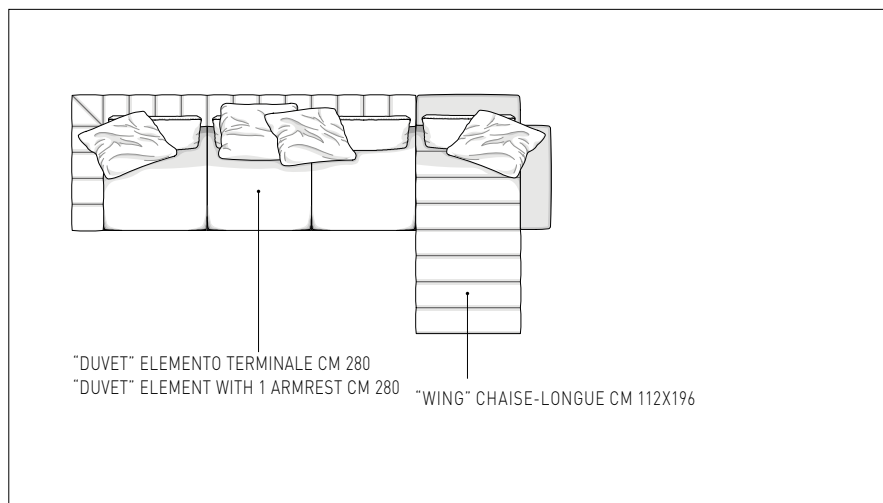

RICERCA ESTETICA E CONFORT OTTIMALE DI SEDUTA | AESTHETIC RESEARCH AND OPTIMAL SEATING COMFORT

Il sistema di sedute Freeman si presenta ricco di contenuti sartoriali, fortemente identificativi dell'unicità del know-how maturato dall'azienda nel corso degli anni. In particolare, le strutture degli elementi Freeman rivelano una confezione complessa quanto raffinata: le varie parti di tessuto sono assemblate tra loro con l'ausilio di una fettuccia in ecopelle color bronzo e doppie cuciture, che conferiscono al tessuto un effetto molto originale. Lo stesso tipo di lavorazione viene eseguito anche sui cuscini dello schienale.

The Freeman seating system has a wealth of couture content that strongly reflects the unique expertise the company has acquired over the years.

Notably, the structures of the Freeman elements reveal a complex and sophisticated construction – the various parts in fabric are joined using a bronze color strip of eco-leather with double-stitched detail, which lends the fabric a very original look. The same type of workmanship also characterizes the backrest cushions.

Das Sitzprogramm Freeman ist reich an Details der Schneiderkunst, die das einzigartige Know-how charakterisieren, das die Firma im Laufe der Jahre entwickelt hat. Im Einzelnen weisen die Strukturen der Elemente Freeman eine ebenso komplexe, wie raffinierte Anfertigungsweise auf: Die verschiedenen Stoffteile werden mit einer doppelten Naht zusammengefügt, in die ein bronzefarbiges Kunstlederband eingearbeitet wird, was dem Stoff einen besonders originellen Effekt gibt. Die gleiche Bearbeitung ist auch für die Rückenissen vorgesehen.

Le système de sièges Freeman est riche en contenus couture, identifiant fortement l'unicité du savoir-faire acquis par l'entreprise au fil des années.

Les structures des éléments Freeman révèlent notamment une confection aussi complexe que raffinée : les différentes parties de tissu sont assemblées entre elles par une bande en éco-cuir couleur Bronze et par de doubles coutures créant un effet très original. Le même type de confection est également réalisé sur les coussins du dossier.



DETTAGLIO IMPUNTURE

LA CONFEZIONE DELLA FODERA CHE RIVESTE LA STRUTTURA VIENE REALIZZATA ASSEMBLANDO LE VARIE PARTI DI TESSUTO CON L'AUSILIO DI UNA FETTUCIA IN ECOPELLE COLOR BRONZO E DOPPIE CUCITURE.

STITCHING DETAIL

FOR THE COVERS ASSEMBLY, THE VARIOUS PARTS IN FABRIC ARE JOINED BY USING A BRONZE-COLORED STRIP OF ECO-LEATHER WITH DOUBLE-STITCHED DETAIL.

ELEMENTI "DUVET", STRUTTURA DI SEDUTA E CUSCINI REVERSIBILI

PREPARAZIONE DELLA STRUTTURA SEDILE IN POLIURETANO ESPANSO A QUOTE DIFFERENZIALI AD ALTA DENSITÀ, REALIZZATA CON SEDI CONCAVE STUDIATE PER ACCOGLIERE CIASCUN CUSCINO SEDILE, AL FINE DI MANTENERE LA STABILITÀ DEL CUSCINO E LA SUA CORRETTA POSIZIONE NEL TEMPO.

CUSCINI SEDILE COMPLETAMENTE REVERSIBILI, CON IMBOTTITURA IN Piuma D'OCA CANALIZZATA E INSERTO CENTRALE IN POLIURETANO ESPANSO A QUOTE DIFFERENZIALI AD ALTA RESILIENZA RIVESTITO DA UN ULTERIORE STRATO DI MEMORY FOAM.

"DUVET" ELEMENTS, SEATING STRUCTURE AND REVERSIBLE CUSHION

THE SEAT STRUCTURE IS MADE OF HIGH RESILIENCE, VARIABLE-DENSITY POLYURETHANE FOAM, WITH A CONCAVE CONTOUR TO CRADLE THE SEAT CUSHION IN ORDER TO MAINTAIN ITS STABILITY AND DURABILITY.

SEAT CUSHIONS ARE COMPLETELY REVERSIBLE, WITH CHANNELED GOOSE DOWN PADDING AND CORE INSERT MADE OF HIGH RESILIENCE, VARIABLE-DENSITY POLYURETHANE FOAM WRAPPED IN A LAYER OF MEMORY FOAM.

ELEMENTI ACCESSORI: POUF, PANCHE E TAVOLINI GRAY/JACOB/CALDER ACCESSORIES: OTTOMANS, BENCHES AND GRAY/JACOB/CALDER COFFEE TABLES

Innovare la progettazione dello spazio living attraverso un sistema di sedute che può attingere da una pluralità di elementi, con caratteristiche differenti, una spiccata personalità estetica, proporzioni eleganti e impareggiabile confort.

Per una progettazione funzionale del sistema di sedute Freeman, si consiglia l'utilizzo dei pouf e delle panche Freeman e dei tavolini Gray/Jacob/Calder, appositamente studiati per creare composizioni "multitasking".

Innovating interior living space design through a seating system displaying into a variety of elements, with different features, a strong aesthetic identity, elegant proportions and unrivaled comfort.

For a functional design of the Freeman seating systems, the use of Freeman ottomans and benches is recommended, as are the Gray/Jacob/Calder coffee tables which were specifically designed to create "multitasking" arrangements.

Die Projektierung des Wohnraums mit einem Sitzprogramm erneuern, das über zahlreiche Elemente verfügt, mit verschiedenen Eigenschaften, einer ausgeprägten, ästhetischen Persönlichkeit, eleganten Proportionen und unvergleichlichem Komfort.

Für ein funktionsgerechtes Projekt des Sitzprogramms Freeman wird empfohlen, die Poufs und Bänke Freeman, sowie die Beistelltische Gray/Jacob/Calder mit einzubeziehen, die spezifisch für "Multitasking" Kompositionen entworfen wurden.

Innovare la conception du séjour par un système de sièges pouvant exploiter une pluralité d'éléments aux caractéristiques différentes, une personnalité esthétique prononcée, des proportions élégantes et un confort sans égal.

Afin de réaliser des projets fonctionnels avec le système de sièges Freeman, il est conseillé d'utiliser des poufs et des bancs Freeman ainsi que des petites tables Gray/Jacob/Calder spécialement étudiées pour créer des compositions "multitasking".

TAVOLINO GRAY | GRAY SIDE TABLE

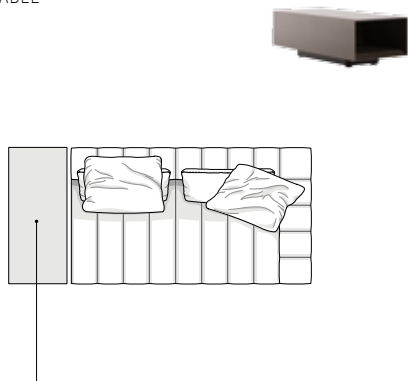

TAVOLINO GRAY CM 47X110 H34 | GRAY SIDE TABLE CM 47X110 H34

TAVOLINO JACOB | JACOB COFFEE TABLE

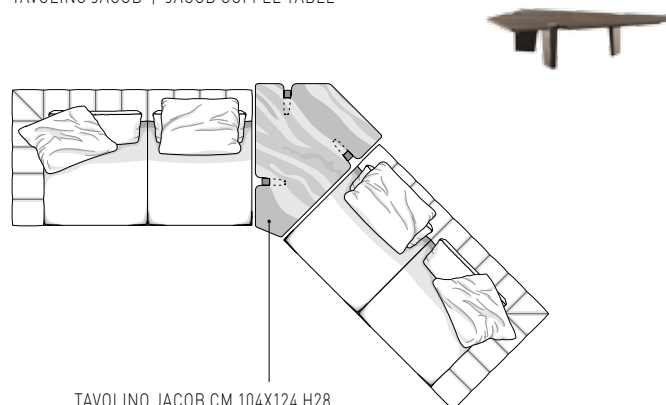

TAVOLINO JACOB CM 104X124 H28
JACOB COFFEE TABLE CM 104X124 H28

CALDER SIDE TABLE



CALDER SIDE TABLE CM 160X35 H38

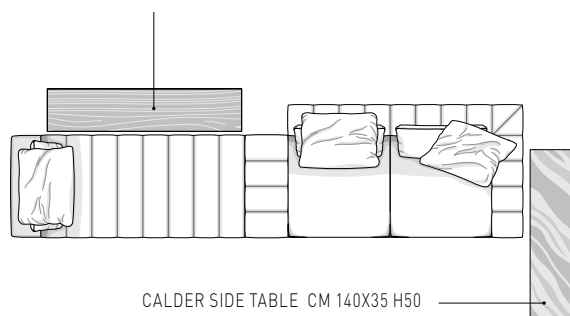

CALDER SIDE TABLE CM 140X35 H50

BRACCIOLO-POUF E PANCHE "STAND ALONE"
ARMREST-OTTOMAN AND "STAND ALONE" BENCHES

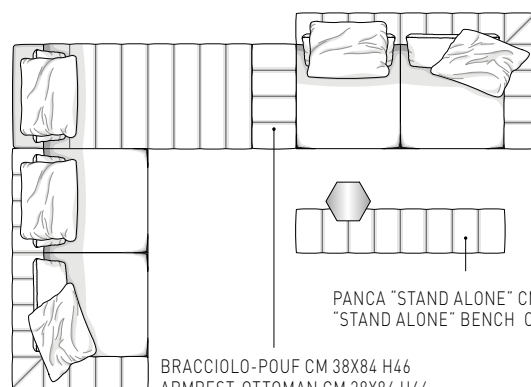

BRACCIOLO-POUF CM 38X84 H46
ARMREST-OTTOMAN CM 38X84 H46

PANCA "STAND ALONE" CM 168X38 H37
"STAND ALONE" BENCH CM 168X38 H37



Struttura: in legno multistrato con molleggio garantito da cinghie elastiche ad alta componente di caucciù. Preparazione della struttura sedile in poliuretano espanso a quote differenziate ad alta densità, realizzata con sedi concave studiate per accogliere ciascun cuscino sedile, al fine di mantenere la stabilità del cuscino e la sua corretta posizione nel tempo. Braccioli e schienali rivestiti con trapuntino di fibra termolegata traspirante accoppiata con tela di cotone bianca anallergica che conferisce morbidezza e sofficietà.

La particolare confezione della fodera della struttura (schienale e braccioli) è realizzata assemblando varie parti di tessuto con l'ausilio di una fettuccia in ecopelle color bronzo fissata tramite una doppia cucitura.

Cuscinata: imbottitura cuscini schienale in piuma d'oca canalizzata (certificata Assopiuma, etichetta oro) con inserto centrale in Memory Foam (materiale termosensibile). Cuscini sedile completamente reversibili, con imbottitura in piuma d'oca canalizzata (certificata Assopiuma, etichetta oro) e inserto centrale in poliuretano espanso a quote differenziate ad alta resilienza rivestito da un ulteriore strato di Memory Foam.

Sfoderabilità: cuscini sedile e schienale completamente sfoderabili in tutte le versioni (tessuto e pelle). Rivestimento della struttura in tessuto sfoderabile rimuovendo la base perimetrale in metallo dopo aver allentato le apposite manopole zigrinate tramite chiave in dotazione. Rivestimento in pelle fisso.

Base: cornice perimetrale in estruso di alluminio con elementi di giunzione in alluminio pressofuso (entrambe su disegno esclusivo Minotti Studio) verniciata lucido anti-touch nel colore Bronzo Chiaro. Appoggio a terra tramite piedini in metallo, verniciati lucido anti-touch nel color Bronzo Chiaro. Scivolante protettivo in SEBS colore bronzo (gomma morbida antigraffio).

Structure: in plywood with suspension provided by high-rubber-content elastic webbing. The seat structure is made of high resilience, variable-density polyurethane foam, with a concave contour to cradle the seat cushion in order to maintain its stability and durability. The armrests and backrest have a breathable heat-bonded quilted fiber casing laminated to a white hypoallergenic cotton fabric which lends softness and comfort.

A special assembly was used for the structure covering (backrest and armrests). The various parts in fabric were joined by using a bronze-colored strip of eco-leather with double-stitched detail.

Cushions: channeled goose down padding for the backrest cushions (Assopiuma certified, gold label) with Memory Foam core insert (temperature-sensitive material). Seat cushions are completely reversible, with channeled goose down padding (Assopiuma certified, gold label) and core insert made of high resilience, variable-density polyurethane foam wrapped in a layer of Memory Foam.

Covers: seat and backrest cushion covers are completely removable in all versions (fabric and leather). The fabric structure covers come off by removing the metal base after loosening the ribbed handles with the key that is provided. Structural leather upholstery is not removable.

Base: extruded aluminum frame with cast aluminum joint fittings (both an exclusive design by Minotti Studio), with a glossy anti-fingerprint Light Bronze painted finish. The metal feet also have a glossy Light Bronze painted finish. Protective bronze-painted SEBS glide (soft scratchproof rubber).

Struktur: Schichtholz mit Federung durch elastische Gurte mit hohem Kautschukinhalt. Aufbereitung der Sitzstruktur mit unterschiedlich dick geschäumtem, hochdichtem Polyurethan mit konkaver Sitzfläche, um die Sitzkissen aufzunehmen, die Kissen fest zu halten und eine dauerhaft korrekte Position zu garantieren. Arm- und Rückenlehnen mit thermosensiblen, atmungsaktivem Steppbezug überzogen, kombiniert mit antiallergischem, weißem Baumwolltuch, das elastische Weichheit verleiht. Die besondere Anfertigung des Strukturbezugs (Rücken- und Armlehnen) wird realisiert, indem die einzelnen Stoffteile mit einer doppelten Naht verbunden werden, in die ein bronzefarbiges Kunstlederband eingefügt wurde.

Kissenpolsterung: Polsterung der Rückenlehnen aus kanalisierten Gänsedaunen (Gold Label, zertifiziert von Assopiuma) mit zentraler Einlage aus Memory Foam (thermosensiblen Material). Sitzkissen beidseitig verwendbar mit Polsterung aus kanalisierten Gänsedaunen (Gold Label, zertifiziert von Assopiuma) mit zentraler Einlage aus unterschiedlich dick geschäumtem, hochdichtem, federndem Polyurethan bezogen mit einer weiteren Schicht von Memory Foam.

Abziehbarkeit: Sitz- und Rückenlehnen, sowie Struktur in allen Varianten (Stoff- und Lederbezug) vollkommen abziehbar. Überzug der Struktur aus abziehbarem Stoff, indem der Gestellrahmen aus Metall abmontiert wird, nachdem die vorgesehenen Drehknöpfe mit dem mitgelieferten Schlüssel gelockert wurden. Lederbezug nicht abziehbar.

Untergestell: Gestellrahmen aus stranggepresstem Aluminium mit Verbindungselementen aus Aluminiumdruckguss (beide ein exklusives Design von Minotti Studio), glänzend mit Anti-Fingerprint Beschichtung, hell bronzenfarbig lackiert. Bodenaufgabe mit Metallfüßchen, glänzend mit Anti-Fingerprint Beschichtung, hell bronzenfarbig lackiert. Gleitschutz aus bronzenfarbigem SEBS (weicher, kratzfester Gummi).

Structure : en multiplis, suspension assurée par des sangles élastiques à haute teneur en caoutchouc. Structure d'assise en polyuréthane expansé à densité différenciée et haute densité, réalisée avec des logements concaves conçus pour accueillir chaque coussin d'assise afin d'en maintenir la stabilité et la position correcte au fil du temps. Accoudoirs et dossiers recouverts d'un petit édredon en fibre thermoliée respirante, doublée de toile de coton blanc anallergique pour davantage de souplesse et de moelleux. Les différentes parties de la housse de la structure (dossier et accoudoirs) sont assemblées, d'une façon originale, à l'aide d'une bande en éco-cuir couleur bronze fixée par une double couture.

Coussins : rembourrage des coussins de dossier en plume d'oie canalisée (certifiée Assopiuma, étiquette d'or) avec insert central en mousse termosensible à mémoire de forme (Memory Foam). Coussins d'assise entièrement réversibles, rembourrage en plume d'oie canalisée (certifiée Assopiuma, étiquette d'or) avec insert central en polyuréthane expansé à densité différenciée haute résilience doublé d'une seconde couche de mousse à mémoire de forme (Memory Foam).

Déhoussage : coussins d'assise et de dossier entièrement déhoussables dans toutes les versions (tissu et cuir). Le revêtement de la structure en tissu se déhousse en démontant la base en métal après avoir desserré les boutons cannelés à l'aide de la clé fournie à cet effet. Revêtement en cuir fixe.

Base : cadre en aluminium extrudé avec éléments de raccordement en aluminium moulé sous pression (d'après un dessin exclusif de Minotti Studio), peinture brillante anti-trace couleur Bronze Clair. Repos sur des pieds en métal, peinture brillante anti-trace couleur Bronze Clair. Patins glisseurs en SEBS couleur Bronze (caoutchouc souple anti-rayure).

FINITURA BASE BASE FINISH

METALLO | METAL

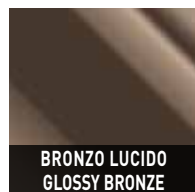

BRONZO LUCIDO
GLOSSY BRONZE

DIVANI | SOFAS

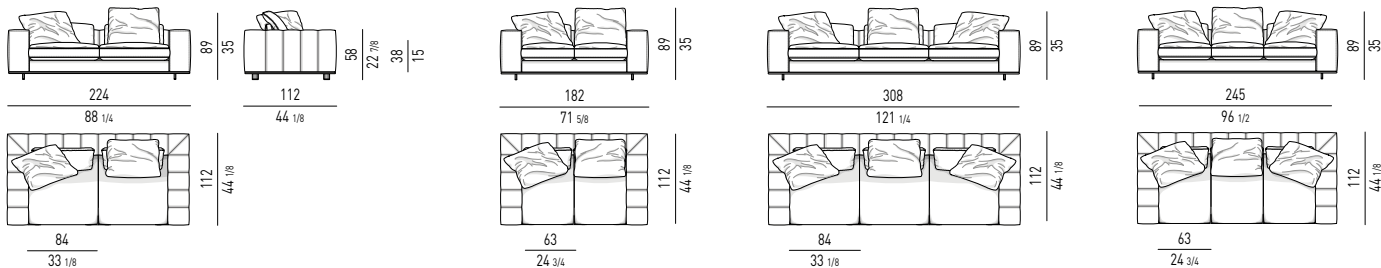

STRUTTURA SENZA CUSCINI
STRUCTURE WITHOUT CUSHIONS

POSIZIONE PIEDINI | FEET POSITION

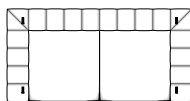
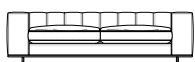

DIVANI COMPOSTI | COMPOSED SOFAS

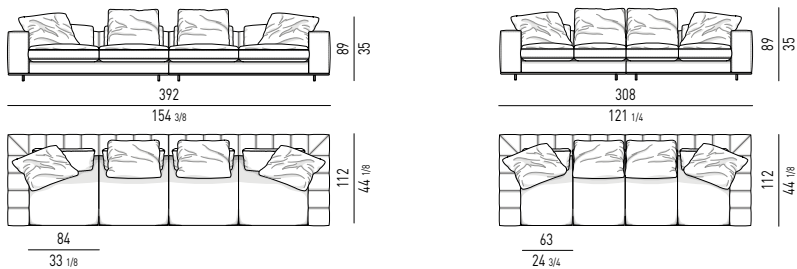

Divano composto da elemento terminale sx e dx cm 196
Arrangement made up of element with armrest sx and dx cm 196

Divano composto da elemento terminale sx e dx cm 154
Arrangement made up of element with armrest sx and dx cm 154

ELEMENTI TERMINALI | ELEMENTS WITH ONE ARMREST

ELEMENTO TERMINALE CM 112
ELEMENT WITH 1 ARMREST CM 112

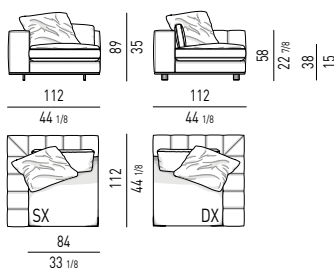

ELEMENTO TERMINALE CM 196
ELEMENT WITH 1 ARMREST CM 196

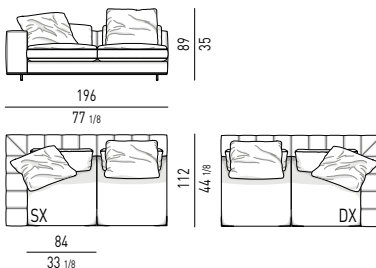

ELEMENTO TERMINALE CM 154
ELEMENT WITH 1 ARMREST CM 154

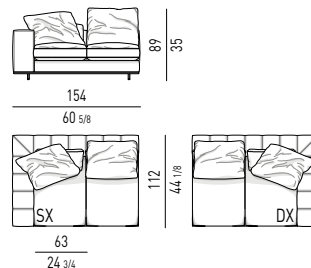

ELEMENTO TERMINALE CM 280
ELEMENT WITH 1 ARMREST CM 280

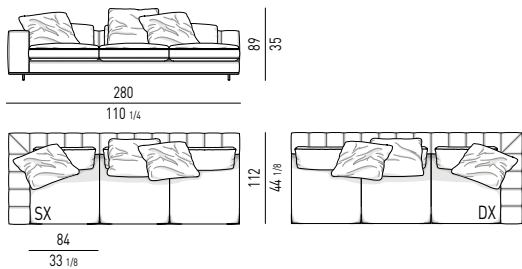

ELEMENTO TERMINALE CM 217
ELEMENT WITH 1 ARMREST CM 217

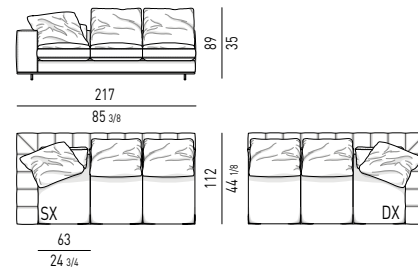

ELEMENTI CENTRALI | CENTRAL ELEMENTS

ELEMENTO CENTRALE CM 168
CENTRAL ELEMENT CM 168

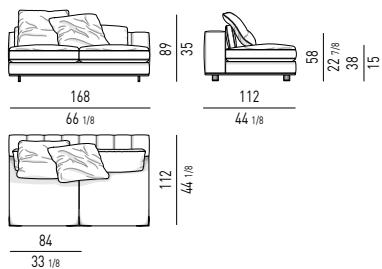

ELEMENTO CENTRALE CM 126
CENTRAL ELEMENT CM 126

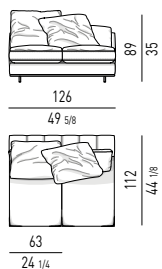

ELEMENTO CENTRALE CM 189
CENTRAL ELEMENT CM 189

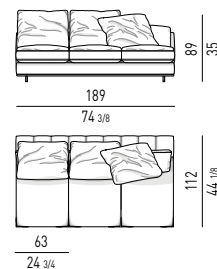

ELEMENTO ANGOLARE | CORNER ELEMENT

ELEMENTO ANGOLARE CM 112
CORNER ELEMENT CM 112

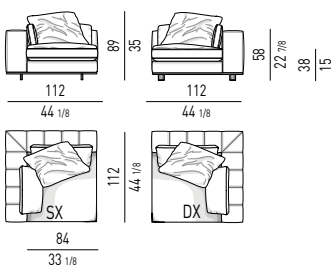

CHAISE-LONGUE

CHAISE-LONGUE CM 112X175

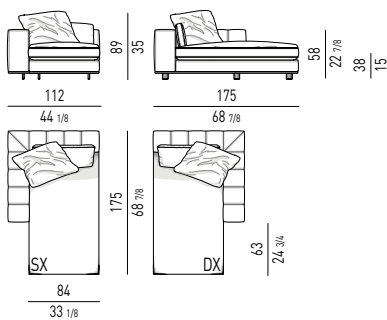

CHAISE-LONGUE CM 154x154

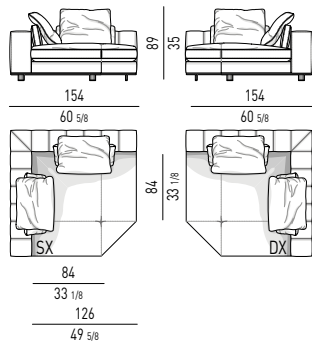

CHAISE-LONGUE CM 175x175

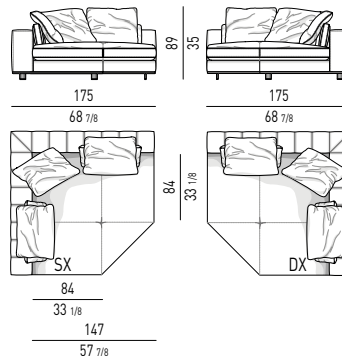

DIVANI ANGOLARI PENISOLA | OPEN-END CORNER SOFAS

DIVANO ANGOLARE PENISOLA 112X238
OPEN-END CORNER SOFA 112X238

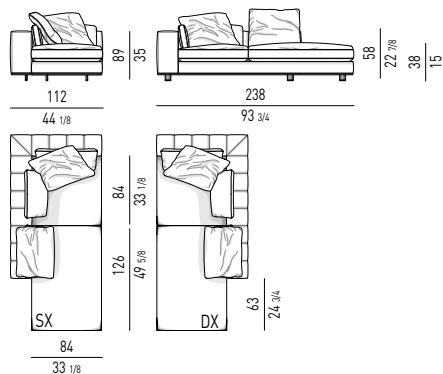

DIVANO ANGOLARE PENISOLA 112X259
OPEN-END CORNER SOFA 112X259

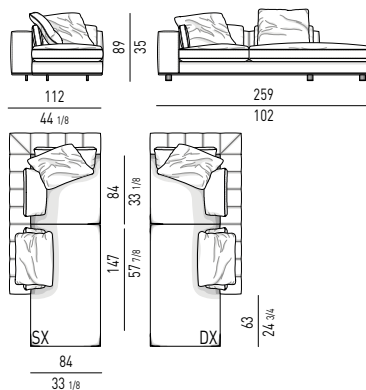

Minotti

ELEMENTI TERMINALI PENISOLA | OPEN-END ELEMENTS WITH ARMREST

ELEMENTO TERMINALE PENISOLA CM 238 - SCHIENALE CM 175
OPEN-END ELEMENT WITH ARMREST CM 238 - BACKREST CM 175

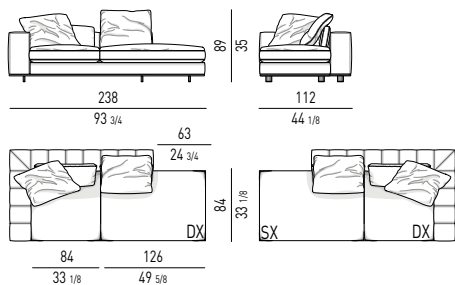

ELEMENTO TERMINALE PENISOLA CM 259 - SCHIENALE CM 196
OPEN-END ELEMENT WITH ARMREST CM 259 - BACKREST CM 196

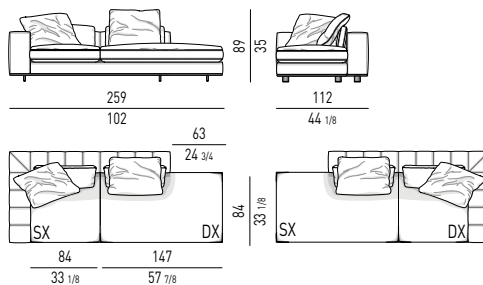

ELEMENTI DAYBED | DAYBED ELEMENTS

ELEMENTO DAYBED CM 175
DAYBED ELEMENT CM 175

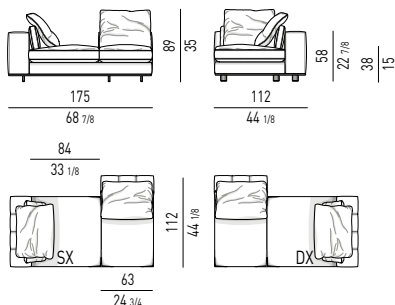

ELEMENTO DAYBED CM 196
DAYBED ELEMENT CM 196

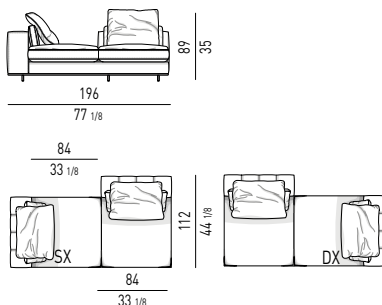

CUSCINO SCHIENALE OPTIONAL "FREEMAN"
"FREEMAN" OPTIONAL BACK CUSHION

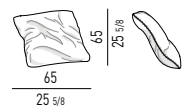

CUSCINI POGGIARENI OPTIONAL "FREEMAN"
FREEMAN OPTIONAL LUMBAR CUSHIONS

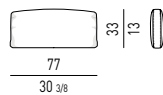
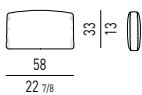

CUSCINO OPTIONAL "FREEMAN"
FREEMAN OPTIONAL CUSHION

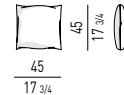

POGGIATESTA OPTIONAL "FREEMAN DUVET"
"FREEMAN DUVET" OPTIONAL HEADREST

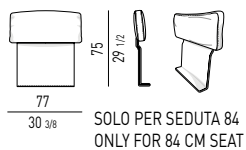
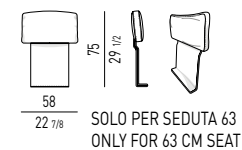



Struttura: in legno multistrato con molleggio garantito da cinghie elastiche ad alta componente di caucciù. Preparazione della struttura sedile in poliuretano espanso ad alta resilienza composto da numerosi strati di quote differenziate. Lo strato superiore è formato da singole fasce sagomate ad alta componente elastica che, aggregate allo strato inferiore, garantiscono una migliore morbidezza nel tempo.

Gli elementi "Wing" e "Mix" hanno un bracciolo e/o schienale in metallo annesso in schiuma poliuretanic ignifuga.

Tutta la struttura è rivestita con trapuntino di fibra termolegata traspirante accoppiata con tela di cotone bianca anallergica che conferisce morbidezza.

La particolare confezione della fodera della struttura (schienale, braccioli e seduta) è realizzata assemblando varie parti di tessuto con l'ausilio di una fettuccia in ecopelle color bronzo fissata tramite una doppia cucitura.

Cuscineria: imbottitura cuscini schienale in piuma d'oca canalizzata (certificata Assopiuma, etichetta oro) con inserto centrale in Memory Foam (materiale termosensibile).

Sfoderabilità: cuscini schienale completamente sfoderabili in tutte le versioni (tessuto e pelle). Elemento "Wing" sfoderabile solo in tessuto.

Rivestimento della struttura in tessuto o pelle sfoderabile rimuovendo la base perimetrale in metallo dopo aver allentato le apposite manopole zigrinate tramite chiave in dotazione.

Base: cornice perimetrale in estruso di alluminio con elementi di giunzione in alluminio pressofuso (entrambe su disegno esclusivo Minotti Studio), verniciata lucido anti-touch nel colore Bronzo Chiaro. Appoggio a terra tramite piedini in metallo, verniciati lucido anti-touch nel color Bronzo Chiaro. Scivolante protettivo in SEBS colore Bronzo (gomma morbida antigraffio).

N.B.: Per agevolare la rimozione del rivestimento e la consegna, i braccioli e gli schienali sono sfilabili dalla base tramite un sistema di innesto e sgancio rapido.

Structure: in plywood with suspension provided by high-rubber-content elastic webbing. The seat structure is made of several layers of variable-density, high resilience polyurethane foam. The upper layer is made of single high-elastic-content contoured straps which, combined with the lower layer, guarantee enhanced softness over time.

"Wing" and "Mix" have an armrest and/or backrest made of a metal frame coated in fireproof polyurethane foam.

The entire structure has a breathable heat-bonded quilted fiber casing laminated to a white hypoallergenic cotton fabric which lends softness.

A special assembly was used for the structure covering (backrest and armrests). The various parts in fabric were joined by using a bronze-colored strip of eco-leather with double-stitched detail.

Cushions: channeled goose down padding for the backrest cushions (Assopiuma certified, gold label) with Memory Foam core insert (temperature-sensitive material).

Covers: backrest cushion covers are completely removable in all the versions (fabric and leather). The "Wing" element cover is removable only for the fabric version.

The fabric or leather removable covers of the structure come off by removing the metal base after loosening the ribbed handles with the key that is provided.

Base: extruded aluminum frame with cast aluminum joint fittings (both an exclusive design by Minotti Studio), with a glossy anti-fingerprint Light Bronze painted finish. The metal feet also have a glossy Light Bronze painted finish. Protective bronze-painted SEBS glide (soft scratchproof rubber).

N.B.: To facilitate transport and removal of covers, the armrests and backrest can be removed from the base by means of a quick coupling and uncoupling system.

Struktur: Schichtholz mit Federung durch elastische Gurte mit hohem Kautschukinhalt. Aufbereitung der Sitzstruktur mit hochelastischen unterschiedlich dick geschäumten, Polyurethanschichten. Die obere Schicht besteht aus einzelnen, hochelastischen Formteilen, die, verbunden mit der darunter liegenden Schicht, eine optimal dauerhafte Weiche garantieren.

Die Elemente "Wing" und "Mix" haben eine Arm- und/oder Rückenlehne aus Metall, eingebettet in feuerfesten Polyurethanschäum.

Die gesamte Struktur ist mit thermosensiblen, atmungsaktivem Steppbezug überzogen, kombiniert mit antiallergischem, weißem Baumwolltuch, das elastische Weichheit verleiht.

Die besondere Anfertigung des Strukturbezugs (Rücken- und Armlehnen) wird realisiert, indem die einzelnen Stoffteile mit einer doppelten Naht verbunden werden, in die ein bronzefarbiges Kunstlederband eingefügt wurde.

Kissenpolsterung: Polsterung der Rückenkissen aus kanalisierten Gänsedaunen (Gold Label, zertifiziert von Assopiuma) mit zentraler Einlage aus Memory Foam (thermosensiblen Material). Das Element "Wing" ist nur mit Stoffbezug abziehbar.

Abziehbarkeit: Rückenkissen in allen Varianten (Stoff- und Lederbezug) vollkommen abziehbar. Überzug der Struktur aus Stoff oder Leder abziehbar, indem der Gestellrahmen aus Metall abmontiert wird, nachdem die vorgesehenen Drehknöpfe mit dem mitgelieferten Schlüssel gelockert wurden.

Untergestell: Gestellrahmen aus stranggepresstem Aluminium mit Verbindungselementen aus Aluminiumdruckguss (beide ein exklusives Design von Minotti Studio), glänzend mit Anti-Fingerprint Beschichtung, hell bronzefarbig lackiert. Bodenaufgabe mit Metallfüßchen, glänzend mit Anti-Fingerprint Beschichtung, hell bronzefarbig lackiert. Gleitschutz aus bronzefarbigem SEBS (weicher, kratzfester Gummi).

N.B.: Um das Abziehen und den Transport zu vereinfachen, sind Arm- und Rückenlehnen über ein praktisches, schnelles Stecksystem mit dem Untergestell verbunden.

Structure : en multiplis, suspension assurée par des sangles élastiques à haute teneur en caoutchouc. Structure d'assise en polyuréthane expansé à haute résilience composé de nombreuses couches à densité différenciée. La couche supérieure est formée de bandes moulées très élastique qui, assemblées à la couche inférieure, sont en mesure de garantir une meilleure souplesse au fil du temps.

Les éléments "Wing" et "Mix" ont un accoudoir et/ou un dossier en métal noyé dans de la mousse polyuréthane ignifuge.

Toute la structure est recouverte d'un petit édreton en fibre thermoliée, doublée de toile de coton blanc anallergique pour davantage de souplesse.

Les différentes parties de la housse de la structure (dossier, accoudoirs et assise) sont assemblées, d'une façon originale, à l'aide d'une bande en éco-cuir couleur bronze fixée par une double couture.

Coussins : rembourrage des coussins de dossier en plume d'oie canalisée (certifiée Assopiuma, étiquette d'or) avec insert central en mousse thermosensible à mémoire de forme (Memory Foam). Seul l'élément "Wing" en tissu est déhoussable.

Déhoussage : coussins de dossier entièrement déhoussables dans toutes les versions (tissu et cuir).

Le revêtement de la structure en tissu se déhousse en démontant la base en métal après avoir desserré les boutons cannelés à l'aide de la clé fournie à cet effet. Revêtement en cuir fixe.

Base : cadre en aluminium extrudé avec éléments de raccordement en aluminium moulé sous pression (d'après un dessin exclusif de Minotti Studio), peinture brillante anti-trace couleur Bronze Clair. Repose sur des pieds en métal, peinture brillante anti-trace couleur Bronze Clair. Patins glisseurs en SEBS couleur Bronze (caoutchouc souple anti-rayure).

N.B. : Pour faciliter le déhoussage et la livraison, les accoudoirs et les dossiers peuvent être désolidarisés de la base grâce à un mécanisme d'enclenchement et déclenchement rapide.

FINITURA BASE BASE FINISH

METALLO | METAL

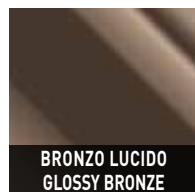

BRONZO LUCIDO
GLOSSY BRONZE

DIVANO | SOFA

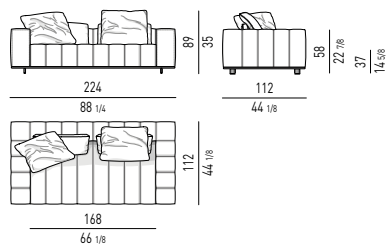

DIVANO COMPOSTO | COMPOSED SOFA

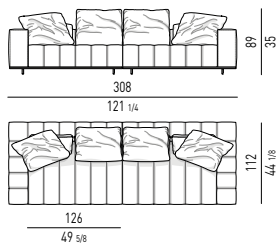

Divano composto da elemento terminale sx e dx cm 154
Arrangement made up of element with armrest sx and dx cm 154

ELEMENTI TERMINALI | ELEMENTS WITH ONE ARMREST

ELEMENTO TERMINALE CM 112 ELEMENT WITH 1 ARMREST CM 112

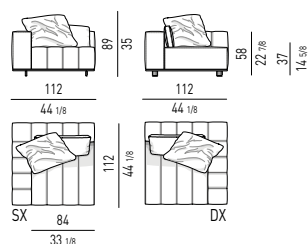

ELEMENTO TERMINALE CM 154 ELEMENT WITH 1 ARMREST CM 154

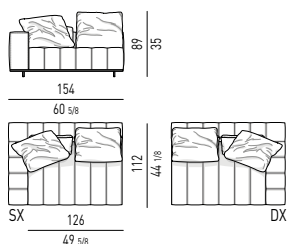

ELEMENTO TERMINALE CM 175 ELEMENT WITH 1 ARMREST CM 175

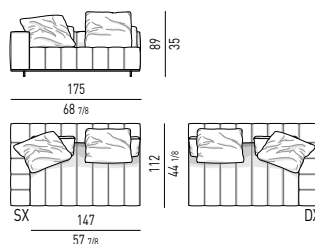

ELEMENTO TERMINALE CM 196 ELEMENT WITH 1 ARMREST CM 196

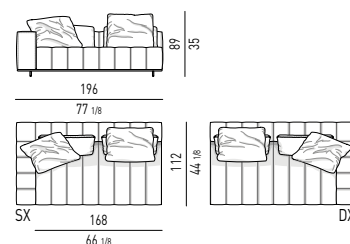

ELEMENTI CENTRALI | CENTRAL ELEMENTS

ELEMENTO CENTRALE CM 84 CENTRAL ELEMENT CM 84

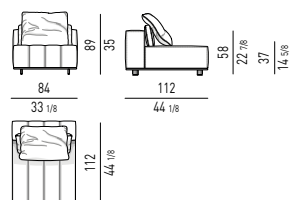

ELEMENTO CENTRALE CM 126 CENTRAL ELEMENT CM 126

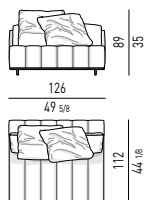

ELEMENTO CENTRALE CM 147 CENTRAL ELEMENT CM 147

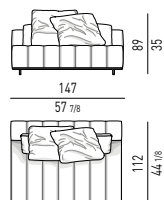

ELEMENTO CENTRALE CM 168 CENTRAL ELEMENT CM 168

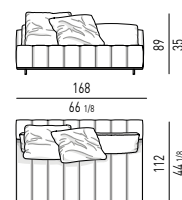

ELEMENTI TERMINALI PENISOLA | OPEN-END ELEMENTS WITH ARMREST

ELEMENTO TERMINALE PENISOLA 175 - SCHIENALE CM 112 OPEN-END ELEMENT WITH ARMREST CM 175 - BACKREST CM 112

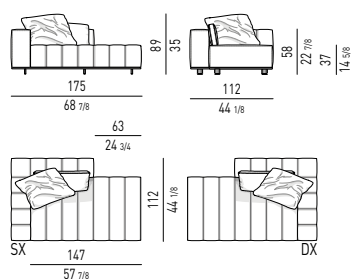

ELEMENTO TERMINALE PENISOLA 196 - SCHIENALE CM 112 OPEN-END ELEMENT WITH ARMREST CM 147 - BACKREST CM 84

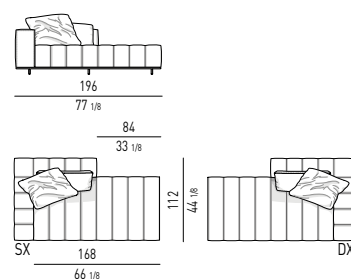

ELEMENTI PENISOLA | OPEN-END ELEMENTS

ELEMENTO PENISOLA CM 147 - SCHIENALE CM 84
OPEN-END ELEMENT CM 147 - BACKREST CM 84

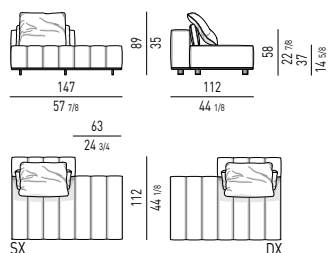

ELEMENTO PENISOLA CM 168 - SCHIENALE CM 84
OPEN-END ELEMENT CM 168 - BACKREST CM 84

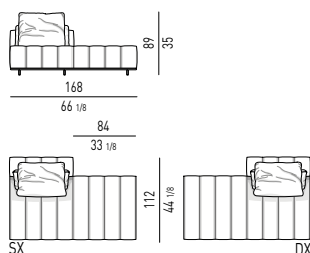

ELEMENTO PENISOLA CM 168 - SCHIENALE CM 126
OPEN-END ELEMENT CM 168 - BACKREST CM 126

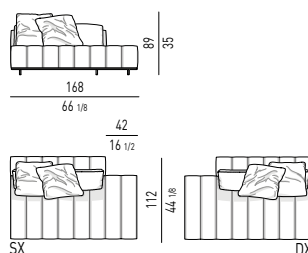

ELEMENTI DAYBED | DAYBED ELEMENTS

ELEMENTO DAYBED CM 175 - SCHIENALE CM 84
DAYBED ELEMENT CM 175 - BACKREST CM 84

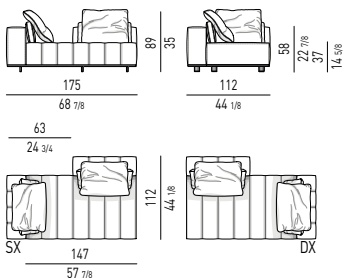

ELEMENTO DAYBED CM 196 - SCHIENALE CM 84
DAYBED ELEMENT CM 196 - BACKREST CM 84

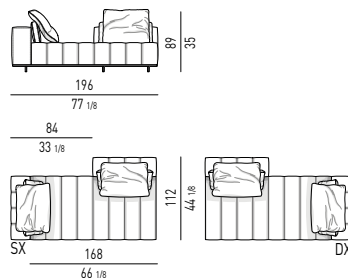

ELEMENTO DAYBED CM 196 - SCHIENALE CM 126
DAYBED ELEMENT CM 196 - BACKREST CM 126

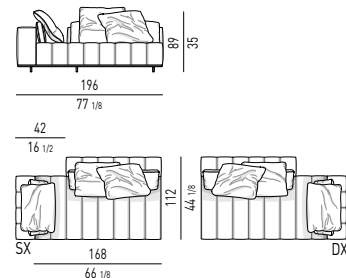

COUCH

COUCH CM 84X175

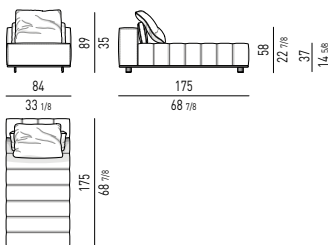

COUCH CM 84X196

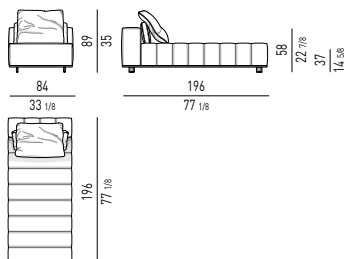

CHAISE-LONGUE

CHAISE-LONGUE CM 112x175

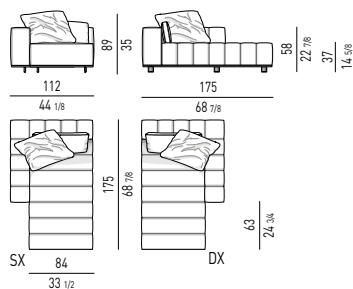

CHAISE-LONGUE CM 112x196

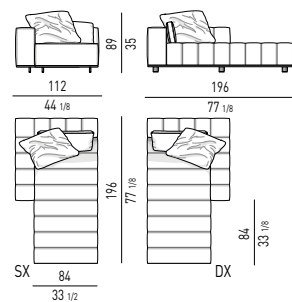

CHAISE-LONGUE CM 175X196

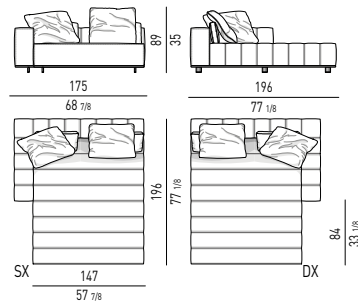

FREEMAN "TAILOR WING" ELEMENTS

DIVANI | SOFAS

WING SOFA CM 168 - N° 2 SCHIENALI CM 84
WING SOFA CM 168 - N° 2 BACKREST CM 84

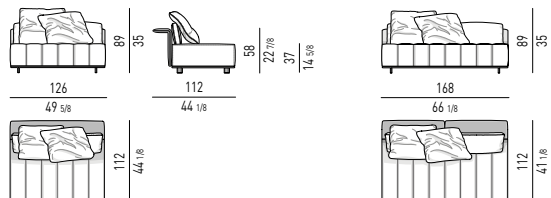

ELEMENTI TERMINALI PENISOLA | OPEN-END ELEMENTS WITH ARMREST

ELEMENTO TERMINALE PENISOLA CM 175 - SCHIENALE CM 84
OPEN-END ELEMENT WITH ARMREST CM 172 - BACKREST CM 84

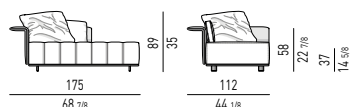

ELEMENTO TERMINALE PENISOLA CM 196 - SCHIENALE CM 84
OPEN-END ELEMENT WITH ARMREST CM 196 - BACKREST CM 84

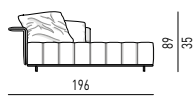

ELEMENTO TERMINALE PENISOLA CM 196 - SCHIENALE CM 126
OPEN-END ELEMENT WITH ARMREST CM 196 - BACKREST CM 126

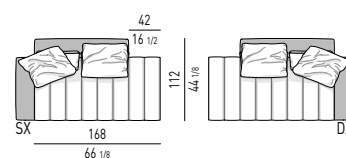
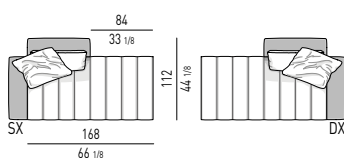
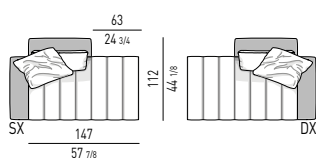
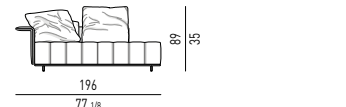

ELEMENTI PENISOLA | OPEN-END ELEMENTS

ELEMENTO PENISOLA CM 147 - SCHIENALE CM 84
OPEN-END ELEMENT CM 147 - BACKREST CM 84

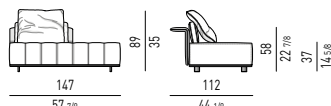

ELEMENTO PENISOLA CM 168 - SCHIENALE CM 84
OPEN-END ELEMENT CM 168 - BACKREST CM 84

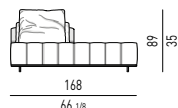

ELEMENTO PENISOLA CM 168 - SCHIENALE CM 126
OPEN-END ELEMENT CM 168 - BACKREST CM 126

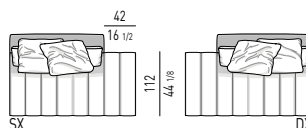
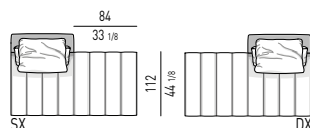
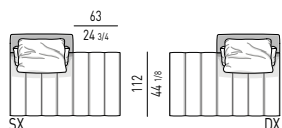
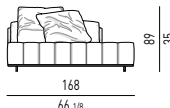

COUCH

COUCH CM 84x172

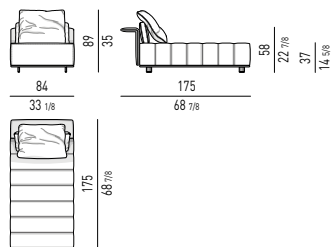

COUCH CM 84x193

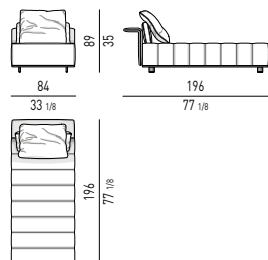

CHAISE-LONGUE

CHAISE-LONGUE CM 112X175

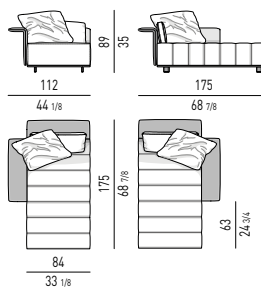

CHAISE-LONGUE CM 112X196

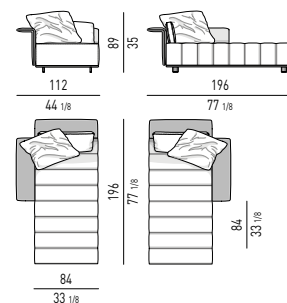

FREEMAN "TAILOR MIX" ELEMENTS

ELEMENTI TERMINALI | ELEMENTS WITH ONE ARMREST

ELEMENTO TERMINALE CM 154
ELEMENT WITH 1 ARMREST CM 154

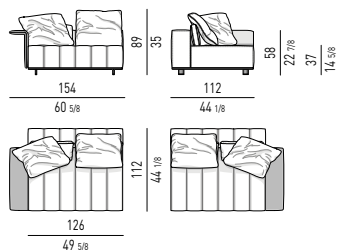

ELEMENTO TERMINALE CM 175
ELEMENT WITH 1 ARMREST CM 175

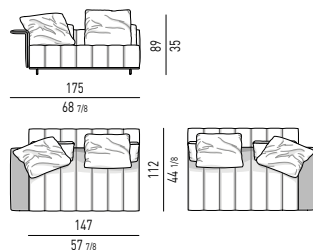

ELEMENTO TERMINALE CM 196
ELEMENT WITH 1 ARMREST CM 193

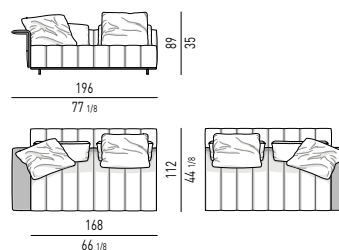

ELEMENTI TERMINALI PENISOLA | OPEN-END ELEMENTS WITH ARMREST

ELEMENTO TERMINALE PENISOLA CM 175 - SCHIENALE CM 84
OPEN-END ELEMENT WITH ARMREST CM 175 - BACKREST CM 84

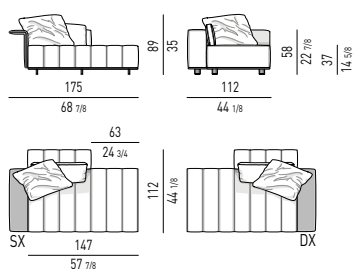

ELEMENTO TERMINALE PENISOLA CM 196 - SCHIENALE CM 84
OPEN-END ELEMENT WITH ARMREST CM 196 - BACKREST CM 84

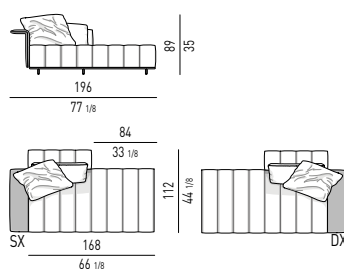

ELEMENTO TERMINALE PENISOLA CM 196 - SCHIENALE CM 126
OPEN-END ELEMENT WITH ARMREST CM 193 - BACKREST CM 126

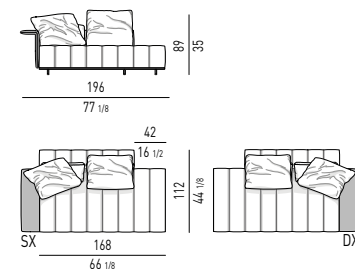

ELEMENTI DAYBED | DAYBED ELEMENTS

ELEMENTO DAYBED CM 196 - SCHIENALE CM 84
DAYBED ELEMENT CM 196 - BACKREST CM 84

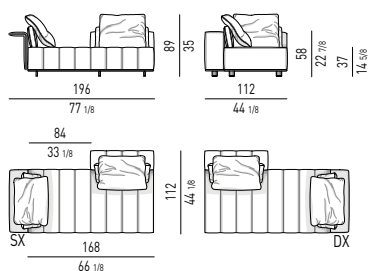

ELEMENTO DAYBED CM 196 - SCHIENALE CM 126
DAYBED ELEMENT CM 1963 - BACKREST CM 126

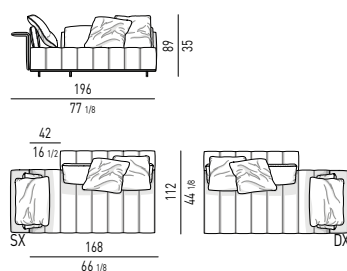

ELEMENTO DAYBED CM 196 - SCHIENALE "WING" CM 84
DAYBED ELEMENT CM 1963 - "WING" BACKREST CM 84

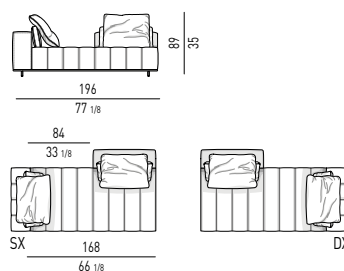

CHAISE-LONGUE

CHAISE-LONGUE CM 112X175

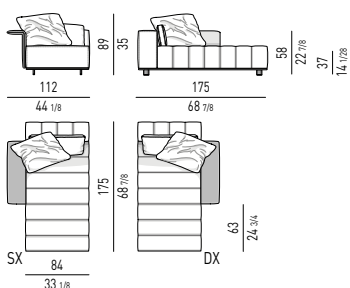

CHAISE-LONGUE CM 112X196

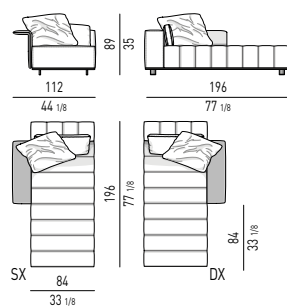

CHAISE-LONGUE CM 175X196

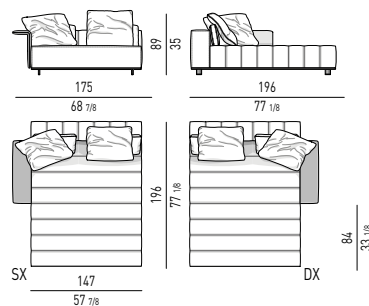

PANCHE | BENCHES

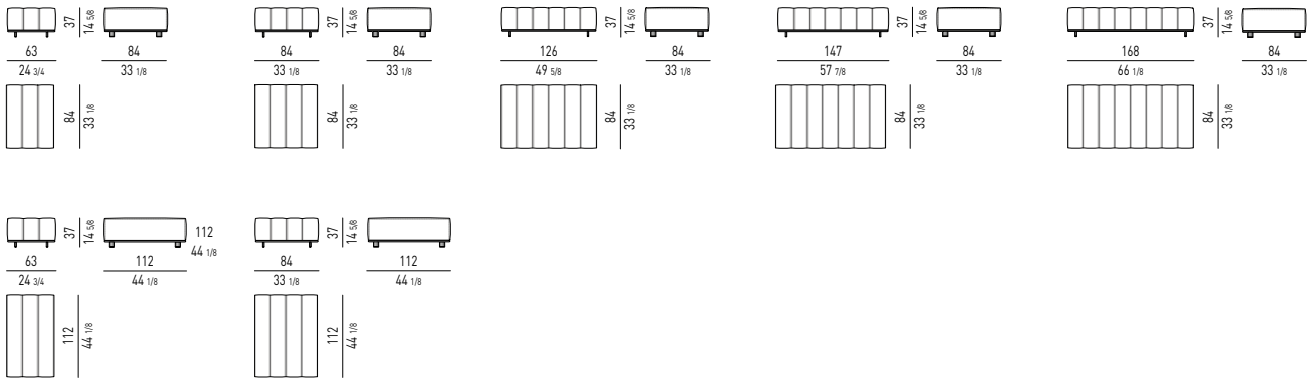

BRACCIOLI-POUF | ARMREST-OTTOMANS

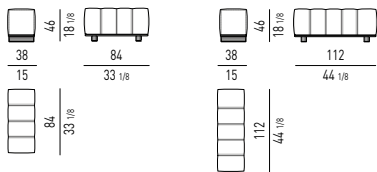

PANCHE "STAND-ALONE" | "STAND-ALONE" BENCHES

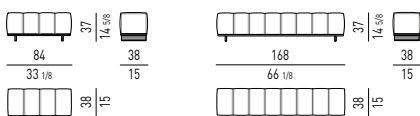

GRAY TAVOLINO | COFFEE TABLE

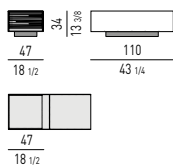

CUSCINO SCHIENALE OPTIONAL "FREEMAN" "FREEMAN" OPTIONAL BACK CUSHION

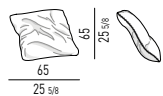

CUSCINI POGGIARENI OPTIONAL "FREEMAN" "FREEMAN" OPTIONAL LUMBAR CUSHIONS

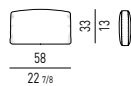

CUSCINO OPTIONAL "FREEMAN" "FREEMAN" OPTIONAL CUSHION

