

D700.SHX.MINI Curve LED Surface Mounted Downlight

Datasheet



TRU-COLOUR.

Product Codes

Unit:	Family:	Colour temp. (K):	Beam Angle:	Color:	Driver:	Version:
D700.SHX.MINI	CR	1.8K.3.1K (1800K-3100K) (Nightshift Dim to Warm) (Special Order) 2.7K (2700K) (Special Order) 3K (3000K) 4K (4000K) (Special Order) 5K (5000K) (Special Order)	36° 50° (Special Order)	B (BLACK) W (WHITE)	PHASE (PHASE)	1.0

Dimensions (mm)

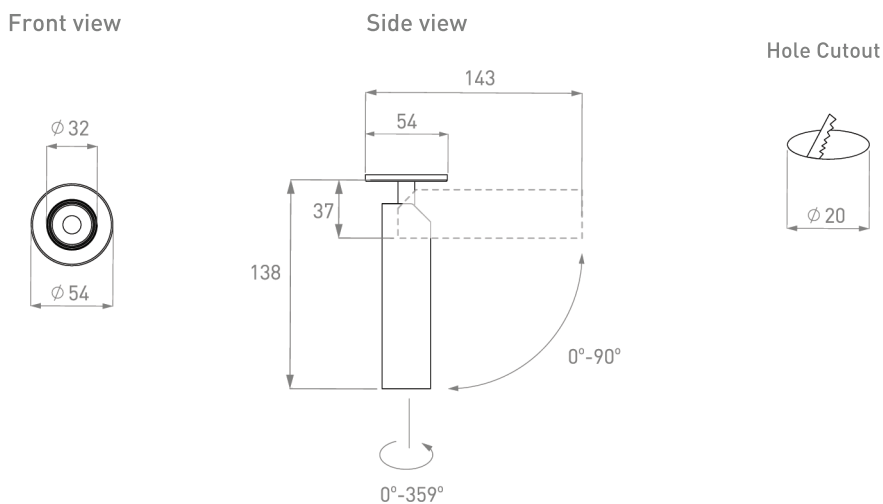

Photometrics

Photometric Diagram

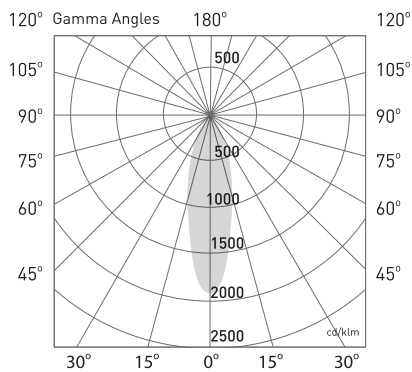

Beam Angle: 36°

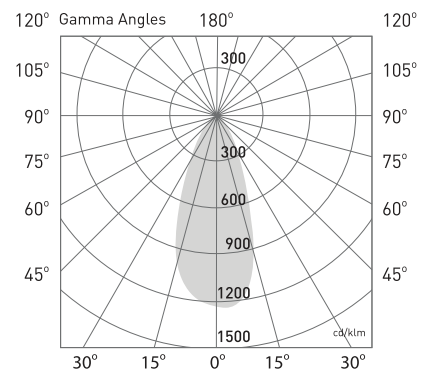

Beam Angle: 50°

CCT Outputs

CCT: 1800K-3100K
Efficacy: 71lm/W
Delivered lumen output: 640lm
CRI: 98
Standard deviation of colour Matching (SDCM): 3 MacAdam steps

CCT: 2700K
Efficacy: 70lm/W
Delivered lumen output: 630lm
CRI: 98
Standard deviation of colour Matching (SDCM): 3 MacAdam steps

CCT: 3000K
Efficacy: 71lm/W
Delivered lumen output: 640lm
CRI: 98
Standard deviation of colour Matching (SDCM): 3 MacAdam steps

CCT: 4000K
Efficacy: 73lm/W
Delivered lumen output: 655lm
CRI: 98
Standard deviation of colour Matching (SDCM): 3 MacAdam steps

CCT: 5000K
Efficacy: 79lm/W
Delivered lumen output: 710lm
CRI: 98
Standard deviation of colour Matching (SDCM): 3 MacAdam steps

Electrical

Input Voltage:
220V-265V

Power Usage:
9W

Driver Power Factor:
>0.9

IP Rating:
IP44

Operational

Ambient Temp.:
-20°C to 50°C

Warranty:
7 Years

Lifetime:
70,000hrs

Installation

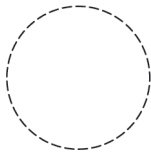

Step 1

Cut a 20mm hole in the ceiling

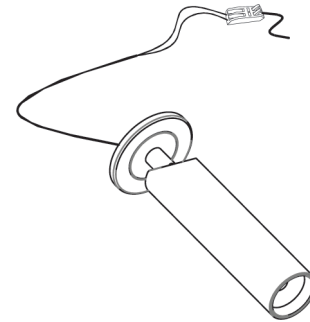

Step 2

Thread the 240V AC power cable through the hole and connect it to the terminal block.

Installation

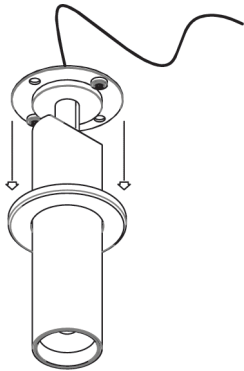

Step 3

Slide the face plate off the ceiling rose to expose the screw mount holes.



Step 4

Fasten the light to the ceiling using the mounting screws provided.

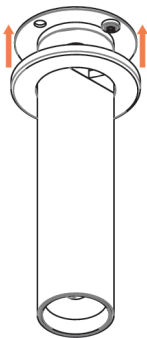

Step 5

Slide the cover back to cover the ceiling mount.

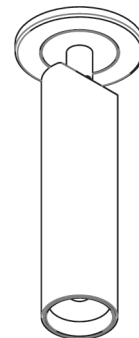

Step 6

Installation complete.