

D550.PLUS PORTAL Curve LED Downlight

Datasheet



TRU-COLOUR®

Product Codes

Unit: D550.PLUS	Series: CR	Colour temp. (K): 2.8K (2800K) 3K (3000K) 4K (4000K) 6K (6000K) 1.8K.3K (1800K-3000K) [Nightshift] 2.8K.6K (2800K-6000K) [Dayshift]	Beam Angle (°): 11 (Very Narrow) 36 (Medium-Narrow)	Inner Colour: B (BLACK) W (WHITE) RALXXXX [Custom Colour]	Control: PH (Phase Dimming) DA (DALI) ZG (ZIGBEE 3.0) CS (CASAMBI) 010 (0-10V)
Light Depth: - (Standard: 18mm) D (Deep: 33mm)	Style: PORTAL	Style Colour: B (BLACK) W (WHITE) RALXXXX [Custom Colour]	Generation: 4.0		

Dimensions (mm)

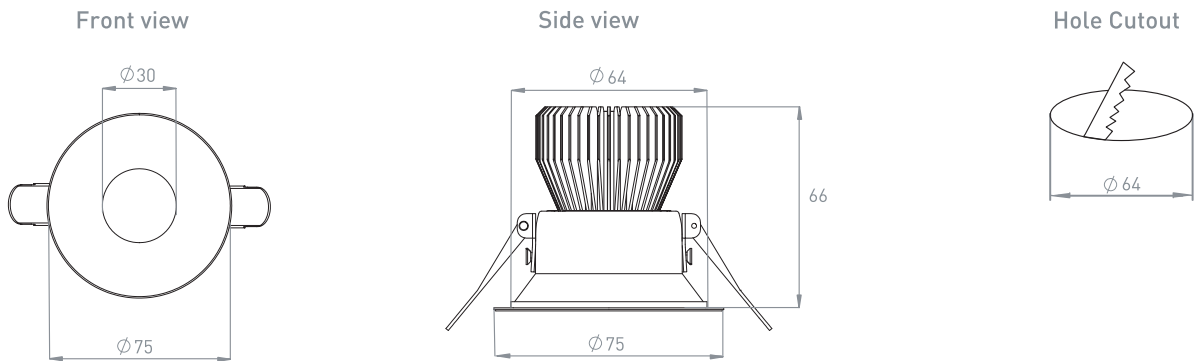

Photometrics

Photometric Diagrams

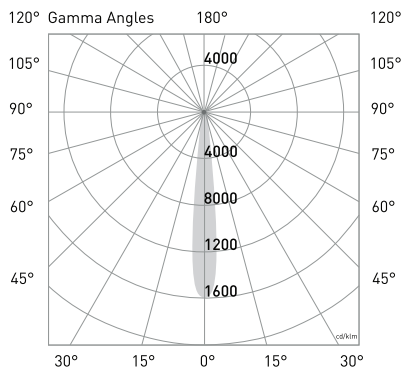

Beam Angle: 11° (Very Narrow)

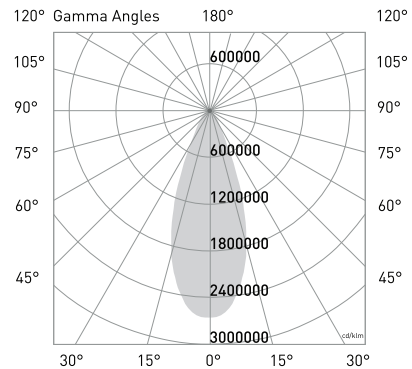

Beam Angle: 36° (Medium-Narrow)

CCT Output

CCT: 2800K
Efficacy: 80lm/W
Delivered lumen output: 560lm
CRI: 98
Standard deviation of colour Matching (SDCM): 2 MacAdam steps

CCT: 3000K
Efficacy: 82lm/W
Delivered lumen output: 570lm
CRI: 98
Standard deviation of colour Matching (SDCM): 2 MacAdam steps

CCT: 4000K
Efficacy: 91lm/W
Delivered lumen output: 640lm
CRI: 98
Standard deviation of colour Matching (SDCM): 2 MacAdam steps

CCT: 6000K
Efficacy: 91lm/W
Delivered lumen output: 635lm
CRI: 98
Standard deviation of colour Matching (SDCM): 2 MacAdam steps

CCT: 1800K-3100K
Efficacy: 82lm/W
Delivered lumen output: 570lm
CRI: 98
Standard deviation of colour Matching (SDCM): 2 MacAdam steps

CCT: 2800K-6000K
Efficacy: 82lm/W
Delivered lumen output: 570lm
CRI: 98
Standard deviation of colour Matching (SDCM): 2 MacAdam steps

Electrical

Input Voltage: 220-265V	Power Usage: 7W	Current: 170mA	Driver Power Factor: >0.9	Dimming: Yes	DC Cable Length: 0.3m	AC Cable Length: 0.6m
-----------------------------------	---------------------------	--------------------------	-------------------------------------	------------------------	---------------------------------	---------------------------------

Note: Dayshift (2.8K.6K) will only work with DALI DT8 or ZIGBEE driver

Physical

Gimbal Angle (°): 17°/ 360°	IP Rating: IP44	IK Rating: IK04
---------------------------------------	---------------------------	---------------------------

Operational

Ambient temp.: -28°C to 60°C	IC Rating: IC-4	UGR: <10 (36° Lens, X=4H, Y=8H)	Lifetime: >100,000 hrs	Warranty: 10 Years
--	---------------------------	---	----------------------------------	------------------------------

Installation

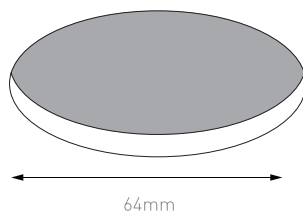

Step 1

Using a 64mm hole saw, cut a hole in the ceiling at the desired location.

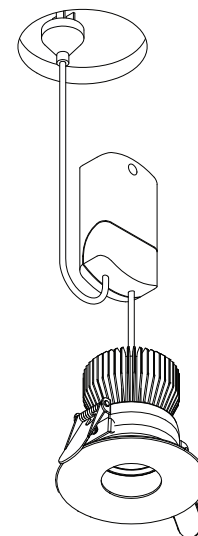

Step 2

Plug the driver into a mounted general power outlet (GPO) in the ceiling.

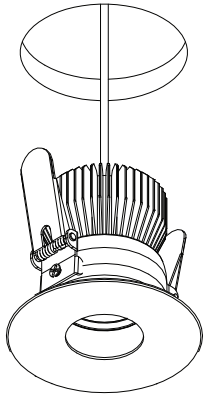

Step 3

Pull back the springs and insert the luminaire into the ceiling cavity. This luminaire can be covered and abutted with insulation.

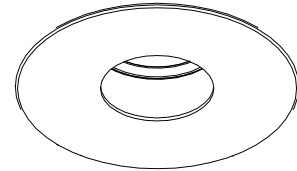

Step 4

Once the light is installed, orient the luminaire using its gimbal to focus the light as required.